

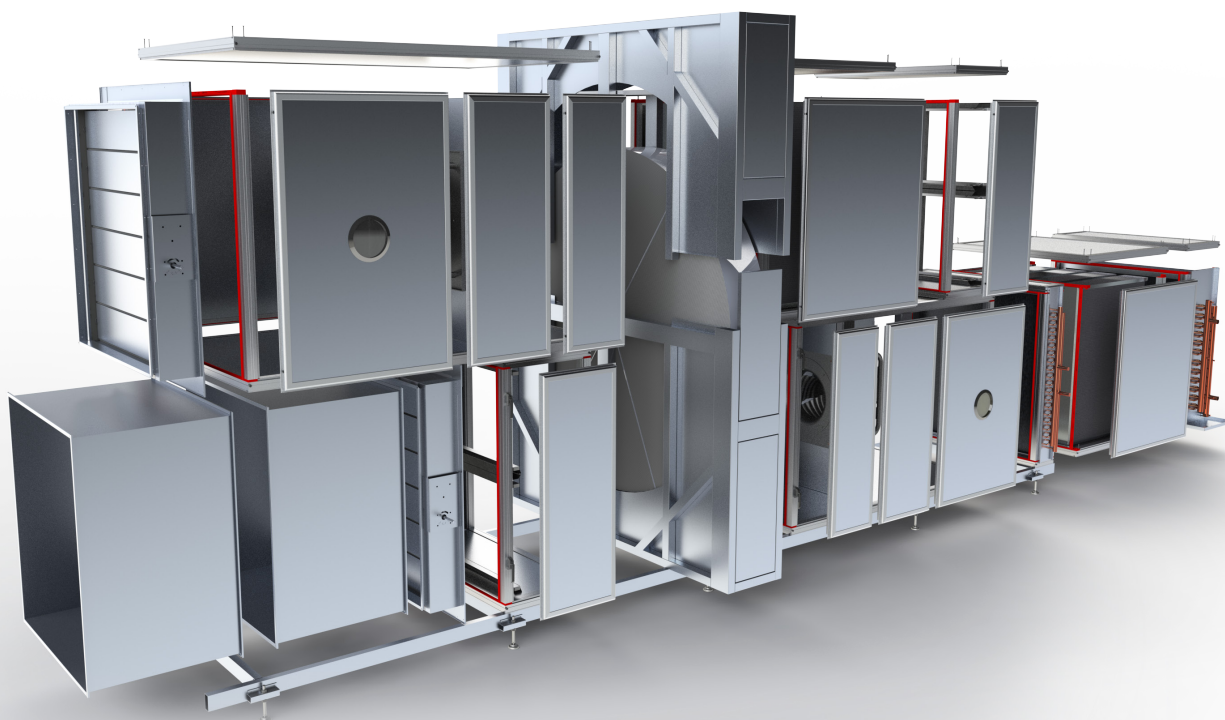

 ETS NORD

Ilmanvaihtotuotteiden hinnasto

Heinäkuu 2022



 **RECAIR**
ETS NORD GROUP

*Let's move the air **together!***

ETS NORD on kansainvälinen ilmanvaihdon kokonaisvaltaisiin ratkaisuihin erikoistunut yritys. Olemme etujoukoissa luomassa uutta ja kestäväää sisätilamukavuuden tulevaisuutta. Tuotantomme ja varastomme sijaitsevat Tuusulassa, Vantaalla, Kumlassa, Malmössa ja Tallinnassa. Huolellisesti suunniteltujen logistiikkajärjestelyjen myötä pystymme takaamaan asiakkaillemme tarkat ja nopeat toimitusajat.

Asiakaslähtöinen työskentely, jatkuva kehittäminen ja vastuullisuus ovat toimintamme kulmakiviä. Laatu- ja ympäristötavoitteiden toteuttamiseen osallistuu aktiivisesti koko ETS NORDin henkilökunta. Tuotekehityksemme perustuu tutkimustuloksiin, vankkaan kokemukseen ja uusiin innovaatioihin. Kuuntelemalla ja osallistamalla asiakkaitamme kykenemme tarjoamaan juuri heidän tarpeitaan vastaavia tuotteita ja ratkaisuja.

Laaja valikoimamme takaa erinomaisen ilmanvaihdon vaativimpaankin kohteeseen. Tuoteryhmiämme ovat muun muassa Eurofins-sertifioidut ja M1-puhtausluokitellut NORDduct-kanavajärjestelmät, kotimaiset Avainlippu-merkityt Recair-ilmankäsittelykoneet, monipuoliset NORDcanopy-huuvut ja laaja NORDfan-puhallinvalikoima.

”Paras LVI-alan verkkokauppa”

Tilauksesi etenee aina nopeimmin helppokäyttöisen ja paljon kehitetyn verkkokauppamme kautta. Voit pilkkoa ja ajastaa toimitukset saapumaan juuri haluttuna ajankohtana. Pyydä tunnukset verkkokauppaamme asiakaspalvelusta tai omalta vastuumyyjältäsi.

Lue lisää tuotteistamme ja kokonaisvaltaisista ilmanvaihdon ratkaisuista www.etsnord.fi

Jari Lehtonen

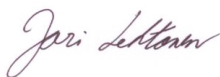

SC0183-10





Ilmanvaihtokanavajärjestelmät

| | |
|---|---------------------------------|
| 1. NORDduct - Pyöreä kanavajärjestelmä, galvanoitu | 4 |
| Kierresaumakanava | NTO |
| Kanava, pituussaumattu | NTOV |
| Käyrä 15, 30, 45, 90 | NVP |
| Käyrä 15, 30, 45, 90 | NV |
| Käyrä jyrkkä 90 | NVK/NVKP/NVKPM |
| Sisäliitin | NI/NIL |
| Ulkoliitin | NM |
| Pitkä sisä-ulkoliitin | NILM |
| Lähtökaulus tasopinnalle | NSK/NSN/NSKM |
| Tulppa | NAL/NALM |
| Tulppa-puhdistusluukku | NALH/NALMH |
| Tulppa-puhdistusluukku, eristetty | NALH-E/NALMH-E |
| Liitinpää | MSG |
| Muunto, keskeinen | NFC/NFCM |
| Muunto, keskeinen | NFCV/NFCVM |
| Muunto, epäkeskeinen | NFB/NFBM |
| Lähtökaulus | NPS |
| Lähtökaulus | NPSK |
| Lähtökaulus | NPSV |
| T-yhde | NTKV |
| T-yhde | NTK |
| Imukartio suojaverkolla | NK/NP |
| Ristiinmenokappale | NTL |
| Saunakanava | TS |
| 2. NORDdoor - Puhdistusluukut | 12 |
| Puhdistusluukku, kanavaosa | TLN3 |
| Puhdistusluukku pyöreälle | TL3/TPL |
| Puhdistusluukku pyöreälle, eristetty | TLPE/TPLE |
| Puhdistusluukku tasopinnalle | TL1/TLT |
| Puhdistusluukku tasopinnalle, eristetty | TLTE |
| 3. NORDdamper – Säätö- ja sulkupellit | 13 |
| Säätöpelti | KROS/KRI |
| Säätö- ja sulkupelti | KRTS-4 |
| Ilmamääräsäädin | RPM-V, RPM-K, RPMC-V, RPMC-K |
| Sälepeltiliitin | KR2/KR4 |
| Sälepeltiliitin | KR4-S |
| Perhospelti | RSKT |
| Säätö- ja sulkupelti | KRU |
| 4. NORDsmoke - Savunhallintajärjestelmät | 16 |
| Pyöreä savunhallintajärjestelmä | |
| Savunhallintapellit | |
| 5. NORDfire - Palotuotteet | 22 |
| Palopelti, pyöreä | FDMS, FDMR, FDMB-R, FDMA-R |
| Palopelti, suorakaide | FDMA, FDMB |
| 6. ETScontrol | 22 |
| Palopeltien ohjaus- ja valvontajärjestelmä | |
| 7. NORDsilencer - Äänenvaimentimet | 23 |
| Pyöreä äänenvaimennin | NRF/NRP |
| Pyöreä äänenvaimennin kasetilla | NRFB/NRPB |
| Äänenvaimennin, suorakaide-pyöreät liitokset, avattava | NKFA/NKPA |
| Äänenvaimennin | NKF/NKP |
| Äänenvaimennin | NKE |
| Taipuisa vaimennin | AKU-COMP |
| Suorakaidekanavien äänenvaimentimet | |
| 8. NORDroof - Kattojärjestelmät | 27 |
| Ilmanottokatos | ULS/URS |
| Ilmanottokatos | ULK/ULSK |
| Ilmastointiokatos | UVE |
| Ulospuhallushajotin | ULV2/ULV2K |
| Sadekatos | NTH |
| Laippa | VRL |
| Kattoläpivihti | MKL |
| Alipainepelti | MKLT |
| Pyöreä liitin | MKLS |
| 9. NORDexternal - Ulkosäleiköt ja lumisuojat | 31 |
| Ulkosäleikkö | RV/RVA |
| Lumisäleikkö | RVL/RVLU |
| Ulkosäleikkö lämmitettävillä säleillä | RVUK |
| Yhdistetty ulko- ja poistoilmalaite | RVC |
| 10. Pyöreä kanavajärjestelmä, 1,2 mm | 32 |
| 11. Pyöreä kanavajärjestelmä, Magnelis (ZM310) | 35 |
| 12. Pyöreä kanavajärjestelmä, haponkestävät | 42 |
| 13. NORDrect – Suorakaidekanavajärjestelmä | 46 |
| 14. NORDaccessories - Asennustarvikkeet | 47 |

Ilmanjakolaitteet

| | |
|---|-----------|
| 1. NORDgrille – Tulo-, poisto- ja siirtoilmäsäleiköt | 49 |
| 2. NORDdiffuser – Ilmanjakolaitteet | 49 |
| 3. Liitäntälaatikot | 50 |

Keittiön ilmanvaihtolaitteet

| | |
|--|-----------|
| NORDcanopy - Keittiön ilmanvaihtolaitteet | 51 |
| Otsonaattori | HZ |
| Tulo- ja poistoilmahuuva | HR |
| Kondenssihuuva | HU |
| Kohdepoistolaite | HT |
| Suodatin | HFK |

NORDfan – Puhaltimet

| | |
|--|-----------|
| | 52 |
|--|-----------|

Recair-ilmankäsittelykoneet

| | |
|------------------------------------|-----------|
| | 52 |
| NORDrect-tilauslomake | 54 |
| NORDsmoke-tilauslomake | 55 |
| Tuotteen kuvaaminen piirustuksella | 57 |
| Kanavien ja kanavaosien pakkaukset | 58 |
| Yleiset toimitusehdot | 59 |

Ilmanvaihtokanavajärjestelmät

Hinnat ovat arvonlisäverottomia (0%).

Varastotuotteet merkattu •

Kaikki mitat millimetreinä (mm), ellei toisin ole mainittu.

NORDduct

1. NORDduct - Pyöreä kanavajärjestelmä, galvanoitu

Kanavat ja kanavaosat standardin SFS-EN 10327 mukaan.

Ainevahvuus:

100...315 – 0,5 mm

400...800 – 0,7 mm

1000...1250 – 0,9 mm

Kierresaumakanava
Pituus 3 m, tulpattu
NTO-3



Kierresaumakanava
Pituus 6 m, tulpattu
NTO-6

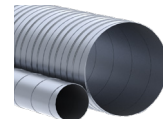

| Koko DØ | Tuotekoodi | LVI-koodi | Hinta €/m | m/ häkki | |
|---------|------------|-----------|-----------|----------|---|
| 80 | 10101083 | 8103307 | 21,40 | 450 | • |
| 100 | 10101013 | 8103322 | 15,54 | 378 | • |
| 125 | 10101123 | 8103323 | 17,17 | 252 | • |
| 160 | 10101163 | 8103324 | 21,50 | 153 | • |
| 200 | 10101203 | 8103325 | 27,73 | 90 | • |
| 250 | 10101253 | 8103326 | 35,83 | 60 | • |
| 315 | 10101313 | 8103327 | 43,07 | 36 | • |
| 400 | 10101403 | 8103328 | 74,45 | 18 | • |
| 500 | 10101503 | 8103329 | 99,05 | 12 | • |
| 630 | 10101633 | 8103330 | 125,51 | | • |
| 800 | 10101803 | 8103331 | 153,44 | | • |
| 1000 | 10101103 | 8103332 | 258,10 | | • |
| 1250 | 10101125-3 | 8103333 | 344,29 | | • |
| 1600 | 10101603 | 8103365 | 625,89 | | |

| Tuotekoodi | LVI-koodi | Hinta €/m | m/ häkki | |
|------------|-----------|-----------|----------|---|
| 110102000 | 8103309 | 21,40 | | |
| 10101016 | 8103310 | 15,54 | 756 | • |
| 10101126 | 8103311 | 17,17 | 504 | • |
| 10101166 | 8103312 | 21,50 | 306 | • |
| 10101206 | 8103313 | 27,73 | 180 | • |
| 10101256 | 8103314 | 35,83 | 120 | • |
| 10101316 | 8103315 | 43,07 | 72 | • |
| 10101406 | 8103316 | 74,45 | 36 | • |
| 10101506 | 8103317 | 99,05 | 24 | • |
| 10101636 | 8103318 | 125,51 | | • |
| 10101806 | 8103319 | 153,44 | | • |
| 10101106 | 8103320 | 258,10 | | • |
| 10101125-6 | 8103321 | 344,29 | | • |
| 10101606 | 8103366 | 625,89 | | |

Kanava (pituussaumattu)
NTOV

Ainevahvuus 0,7 mm
Max pituus
100...160 -1000 mm
200...1250 -2000 mm

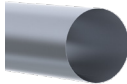

| Koko dØ | Tuotekoodi | LVI-koodi | Hinta €/kpl |
|---------|------------|-----------|-------------|
| 100 | 10220100 | 8105858 | 44,58 |
| 125 | 10220125 | 8105859 | 52,00 |
| 160 | 10220160 | 8105860 | 63,54 |
| 200 | 10220200 | 8105861 | 116,36 |
| 250 | 10220250 | 8105862 | 141,34 |
| 315 | 10220315 | 8105863 | 171,50 |
| 400 | 10220400 | 8105864 | 209,55 |
| 500 | 10220500 | 8105865 | 257,74 |

Käyrä
NVP 90°



| Koko dØ | Tuotekoodi | LVI-koodi | Hinta €/kpl | kpl/ laatikko | |
|---------|------------|-----------|-------------|---------------|---|
| 80 | 110106000 | 8100092 | 23,18 | 85 | • |
| 100 | 10202019 | 8100094 | 12,86 | 55 | • |
| 125 | 10202129 | 8100096 | 15,62 | 30 | • |
| 160 | 10202169 | 8100098 | 22,60 | 65 | • |
| 200 | 10202209 | 8100100 | 38,29 | 40 | • |

Käyrä
NVP 60°



| Tuotekoodi | LVI-koodi | Hinta €/kpl | kpl/ laatikko | |
|------------|-----------|-------------|---------------|---|
| 10202016 | 8100852 | 24,15 | 40 | • |
| 10202126 | 8100853 | 25,10 | 22 | • |
| 10202166 | 8100854 | 41,69 | 20 | • |
| 10202206 | 8100855 | 44,22 | 12 | • |

Käyrä
NVP 45°



| Koko dØ | Tuotekoodi | LVI-koodi | Hinta €/kpl | kpl/ laatikko | |
|---------|------------|-----------|-------------|---------------|---|
| 80 | 110113002 | 8100122 | 15,09 | 16 | • |
| 100 | 10202014 | 8100124 | 13,20 | 60 | • |
| 125 | 10202124 | 8100126 | 13,64 | 50 | • |
| 160 | 10202164 | 8100128 | 22,15 | 25 | • |
| 200 | 10202204 | 8100130 | 29,08 | 60 | • |

Käyrä
NVP 30°



| Tuotekoodi | LVI-koodi | Hinta €/kpl | kpl/ laatikko | |
|------------|-----------|-------------|---------------|---|
| 10202013 | 8100153 | 14,89 | 75 | • |
| 10202123 | 8100154 | 17,51 | 40 | • |
| 10202163 | 8100155 | 21,35 | 22 | • |
| 10202203 | 8100156 | 28,99 | 20 | • |

Käyrä
NVP 15°



| Tuotekoodi | LVI-koodi | Hinta €/kpl | kpl/ laatikko | |
|------------|-----------|-------------|---------------|---|
| 10202013-1 | 8100872 | 12,22 | 18 | • |
| 10202123-1 | 8100873 | 19,19 | 27 | • |
| 10202163-1 | 8100874 | 19,60 | 15 | • |
| 102022015 | 8100875 | 24,99 | 12 | • |

NORDduct - Pyöreä kanavajärjestelmä, galvanoitu
**Käyrä
NV 90°**

| Koko dØ | Tuotekoodi | LVI-koodi | Hinta €/kpl | kpl/laatikko |
|---------|------------|-----------|-------------|--------------|
| 250 | 10202259 | 8100102 | 51,49 | 18 • |
| 315 | 10202319 | 8100104 | 64,73 | • |
| 400 | 10202409 | 8100106 | 84,41 | • |
| 500 | 10202509 | 8100108 | 112,73 | • |
| 630 | 10202639 | 8100110 | 204,12 | • |
| 800 | 10202809 | 8100112 | 447,67 | • |
| 1000 | 10202109 | 8100114 | 823,07 | • |
| 1250 | 10202125-9 | 8100116 | 1256,50 | • |

**Käyrä
NV 60°**

| Tuotekoodi | LVI-koodi | Hinta €/kpl | kpl/laatikko |
|------------|-----------|-------------|--------------|
| 10202256 | 8100856 | 45,33 | 24 |
| 10202316 | 8100857 | 45,79 | 10 |
| 10202406 | 8100858 | 63,29 | 5 |
| 10202506 | 8100859 | 85,27 | • |
| 10202636 | 8100860 | 145,40 | • |
| 10202806 | 8100861 | 285,09 | • |
| 10202106 | 8100862 | 549,96 | • |
| 10202125-6 | 8100863 | 865,10 | • |

**Käyrä
NV 45°**

| Tuotekoodi | LVI-koodi | Hinta €/kpl | kpl/laatikko |
|------------|-----------|-------------|--------------|
| 10202254 | 8100132 | 36,40 | 32 • |
| 10202314 | 8100134 | 46,35 | 15 • |
| 10202404 | 8100136 | 63,11 | • |
| 10202504 | 8100138 | 83,39 | • |
| 10202634 | 8100140 | 130,52 | • |
| 10202804 | 8100142 | 307,22 | • |
| 10202104 | 8100144 | 469,88 | • |
| 10202125-4 | 8100146 | 796,71 | • |

**Käyrä
NV 30°**

| Koko dØ | Tuotekoodi | LVI-koodi | Hinta €/kpl | kpl/laatikko |
|---------|------------|-----------|-------------|--------------|
| 250 | 10202253 | 8100157 | 36,41 | 7 • |
| 315 | 10202313 | 8100158 | 46,32 | 4 • |
| 400 | 10202403 | 8100159 | 58,01 | 12 • |
| 500 | 10202503 | 8100160 | 68,09 | 4 • |
| 630 | 10202633 | 8100161 | 111,42 | • |
| 800 | 10202803 | 8100162 | 257,13 | • |
| 1000 | 10202103 | 8100163 | 436,10 | • |
| 1250 | 10202125-3 | 8100164 | 709,07 | • |

**Käyrä
NV 15°**

| Tuotekoodi | LVI-koodi | Hinta €/kpl | kpl/laatikko |
|------------|-----------|-------------|--------------|
| 10202253-1 | 8100876 | 27,30 | 12 • |
| 10202315 | 8100877 | 37,10 | 7 • |
| 102024015 | 8100878 | 47,83 | 16 • |
| 10202502 | 8100879 | 60,27 | 8 • |
| 10202631 | 8100880 | 86,55 | • |
| 10202803-1 | 8100881 | 149,52 | • |
| 10202103-1 | 8100882 | 342,55 | • |
| 10202125-2 | 8100883 | 533,10 | • |

**Käyrä, jyrkkä
NVK 90°**

| Tuotekoodi | LVI-koodi | Hinta €/kpl | kpl/laatikko |
|------------|-----------|-------------|--------------|
| 10202009 | 8100077 | 79,30 | 12 • |
| 10203259 | 8100078 | 101,26 | 24 • |
| 10203319 | 8100079 | 122,22 | 10 • |
| 10203409 | 8100080 | 163,76 | 6 • |
| 10203509 | 8100081 | 209,38 | • |
| 10203639 | 8100082 | 331,16 | • |
| 10203809 | 8100083 | 644,46 | • |
| 10203109 | 8100084 | 1149,89 | • |
| 10203129 | 8100085 | 1705,83 | • |

**Käyrä, jyrkkä
NVKP 90°**

| Koko dØ | Tuotekoodi | LVI-koodi | Hinta €/kpl | kpl/laatikko |
|---------|------------|-----------|-------------|--------------|
| 100 | 10201019 | 8100074 | 34,98 | 50 • |
| 125 | 10201209 | 8100075 | 39,81 | 30 • |
| 160 | 10201619 | 8100076 | 48,74 | 15 • |
| 200 | | | | |
| 250 | | | | |
| 315 | | | | |
| 400 | | | | |
| 500 | | | | |
| 630 | | | | |

**Käyrä, jyrkkä
kanava/osa
NVKPM 90°**

| Tuotekoodi | LVI-koodi | Hinta €/kpl | kpl/laatikko |
|------------|-----------|-------------|--------------|
| 110116020 | 8105793 | 47,29 | 50 • |
| 110116021 | 8105794 | 55,37 | 30 • |
| 110116022 | 8105795 | 67,94 | 15 • |
| | | | |
| | | | |
| | | | |
| | | | |
| | | | |
| | | | |

**Käyrä, jyrkkä
kanava/osa
NVKM 90°**

| Tuotekoodi | LVI-koodi | Hinta €/kpl | kpl/laatikko |
|------------|-----------|-------------|--------------|
| 110116019 | 8105890 | 95,28 | 12 • |
| 110116024 | 8105798 | 123,68 | 24 • |
| 110116025 | 8105799 | 157,14 | 10 • |
| 110116026 | 8105800 | 210,89 | 6 • |
| 110116027 | 8105801 | 269,40 | • |
| 110116028 | 8105802 | 409,26 | • |

Ilmanvaihtokanavajärjestelmät

NORDduct - Pyöreä kanavajärjestelmä, galvanoitu

Sisäliitin NI



| Koko dØ | Tuotekoodi | LVI-koodi | Hinta €/kpl | kpl/laatikko |
|---------|------------|-----------|-------------|--------------|
| 100 | 10203010 | 8100674 | 8,01 | 150 |
| 125 | 10203120 | 8100676 | 8,27 | 90 |
| 160 | 10203160 | 8100678 | 8,60 | 55 |
| 200 | 10203200 | 8100680 | 10,18 | 57 |
| 250 | 10203250 | 8100682 | 13,80 | 24 |
| 315 | 10203310 | 8100684 | 17,45 | 14 |
| 400 | 10203400 | 8100686 | 24,62 | 40 |
| 500 | 10203500 | 8100688 | 30,56 | 22 |
| 630 | 10203630 | 8100690 | 45,67 | 16 |
| 800 | 10203800 | 8100692 | 89,26 | 15 |
| 1000 | 10203100 | 8100694 | 147,00 | 15 |
| 1250 | 10203125 | 8100696 | 206,28 | 15 |

Pitkä sisäliitin NIL



| Tuotekoodi | LVI-koodi | Hinta €/kpl | kpl/laatikko |
|------------|-----------|-------------|--------------|
| 10217100 | 8103815 | 13,35 | 26 |
| 10217125 | 8103816 | 14,20 | 18 |
| 10217160 | 8103817 | 15,72 | 8 |
| 10217200 | 8103818 | 19,93 | 16 |
| 10217250 | 8103819 | 22,05 | 6 |
| 10217315 | 8103820 | 24,95 | 5 |
| 10217400 | 8103821 | 45,20 | 4 |
| 10217500 | 8103836 | 64,85 | 4 |
| 10217630 | 8103837 | 77,43 | 4 |
| 10217800 | 8103839 | 137,34 | |
| 10217100-1 | 8103840 | 185,70 | |
| 102171200 | 8103841 | 242,92 | |

Ulkoliitin NM



| Tuotekoodi | LVI-koodi | Hinta €/kpl | kpl/laatikko |
|------------|-----------|-------------|--------------|
| 10204010 | 8100704 | 4,20 | 133 |
| 10204120 | 8100706 | 4,52 | 90 |
| 10204160 | 8100708 | 4,85 | 50 |
| 10204200 | 8100710 | 5,51 | 54 |
| 10204250 | 8100712 | 8,93 | 24 |
| 10204310 | 8100714 | 10,88 | 10 |
| 10204400 | 8100716 | 15,59 | 8 |
| 10204500 | 8100718 | 21,43 | 20 |
| 10204630 | 8100720 | 24,98 | 12 |
| 10204800 | 8100722 | 49,57 | |
| 10204100 | 8100724 | 68,32 | |
| 10204125 | 8100726 | 81,87 | |

Pitkä sisä-ulkoliitin NILM

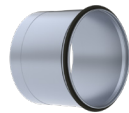

| Koko dØ | Tuotekoodi | LVI-koodi | Hinta €/kpl | kpl/laatikko |
|---------|------------|-----------|-------------|--------------|
| 100 | 10222100 | 8103902 | 15,45 | 9 |
| 125 | 10222125 | 8103906 | 15,98 | 13 |
| 160 | 10222160 | 8103908 | 17,12 | 8 |
| 200 | 10222200 | 8103910 | 20,62 | 14 |
| 250 | 10222250 | 8103912 | 24,43 | 6 |
| 315 | 10222315 | 8103914 | 27,63 | 4 |
| 400 | 10222400 | 8103916 | 49,73 | 3 |
| 500 | 10222500 | 8103918 | 74,59 | 4 |
| 630 | 10222630 | 8103920 | 166,88 | |
| 800 | | | | |
| 1000 | | | | |
| 1250 | | | | |

Lähtökaulus tasopinnalle, jyrkkä NSK



| Tuotekoodi | LVI-koodi | Hinta €/kpl | kpl/laatikko |
|------------|-----------|-------------|--------------|
| 10205010 | 8100757 | 7,85 | 70 |
| 10205120 | 8100758 | 8,80 | 95 |
| 10205160 | 8100759 | 10,39 | 100 |
| 10205200 | 8100760 | 12,17 | 70 |
| 10205250 | 8100761 | 15,00 | 60 |
| 10205310 | 8100762 | 19,47 | 25 |
| 10205400 | 8100763 | 30,23 | 13 |
| 10205500 | 8100764 | 39,49 | 45 |
| 10205630 | 8100766 | 47,86 | 37 |
| 10205800 | 8100767 | 73,86 | 10 |
| 10205100 | 8100768 | 92,69 | 1 |
| 10205125 | 8100769 | 133,45 | 1 |

Lähtökaulus tasopinnalle, kartio NSN



| Tuotekoodi | LVI-koodi | Hinta €/kpl | kpl/laatikko |
|------------|-----------|-------------|--------------|
| 102059100 | 8100732 | 11,24 | 40 |
| 102059125 | 8100734 | 12,05 | 50 |
| 102059160 | 8100736 | 14,44 | 50 |
| 102059200 | 8100738 | 17,34 | 50 |
| 102059250 | 8100740 | 19,33 | 20 |
| 102059315 | 8100742 | 29,30 | 18 |
| 102059400 | 8100744 | 96,62 | 42 |
| 102059500 | 8100746 | 135,07 | 34 |
| 102059630 | 8100748 | 235,53 | 20 |

Lähtökaulus tasopinnalle, osalle NSKM



| Koko Ød | Tuotekoodi | LVI-koodi | Hinta €/kpl | kpl/laatikko |
|---------|------------|-----------|-------------|--------------|
| 100 | 10206010 | 8100771 | 6,99 | 85 |
| 125 | 10206120 | 8100772 | 8,02 | 60 |
| 160 | 10206160 | 8100773 | 9,42 | 40 |
| 200 | 10206200 | 8100774 | 10,84 | 25 |
| 250 | 10206250 | 8100775 | 13,50 | 28 |
| 315 | 10206315 | 8100776 | 17,60 | 20 |
| 400 | 10206400 | 8100777 | 34,20 | 13 |
| 500 | 10206500 | 8100778 | 50,36 | |
| 630 | 10206630 | 8100779 | 75,56 | |
| 800 | 10206800-1 | 8100780 | 136,51 | |
| 1000 | 10206100 | 8100781 | 173,45 | |
| 1250 | 10206125 | 8100782 | 206,49 | |

Tulppa kanavalle NAL



| Tuotekoodi | LVI-koodi | Hinta €/kpl | kpl/laatikko |
|------------|-----------|-------------|--------------|
| 10208010 | 8100644 | 15,40 | 90 |
| 10208120 | 8100646 | 15,93 | 110 |
| 10208160 | 8100648 | 16,70 | 36 |
| 10208200 | 8100650 | 20,06 | 45 |
| 10208250 | 8100652 | 30,80 | 25 |
| 10208310 | 8100654 | 41,55 | 22 |
| 10208400 | 8100656 | 61,10 | 12 |
| 10208500 | 8100658 | 64,43 | 36 |
| 10208630 | 8100660 | 89,86 | 24 |
| 10208800 | 8100662 | 165,26 | 12 |
| 10208100 | 8100664 | 191,49 | |
| 10208150 | 8100666 | 269,69 | |

Tulppa osalle NALM



| Tuotekoodi | LVI-koodi | Hinta €/kpl | kpl/laatikko |
|-------------|-----------|-------------|--------------|
| 10208010-1 | 8100614 | 5,36 | 50 |
| 10208120-1 | 8100616 | 6,60 | 45 |
| 102081160-1 | 8100618 | 8,22 | 50 |
| 10208220-1 | 8100620 | 9,70 | 40 |
| 10208225-1 | 8100622 | 14,96 | 55 |
| 10208231-1 | 8100624 | 18,30 | 40 |
| 10208240-1 | 8100626 | 28,08 | 15 |
| 10208250-0 | 8100628 | 42,02 | 6 |
| 10208220-6 | 8100630 | 53,32 | 20 |
| 10208220-8 | 8100632 | 117,43 | 12 |
| 10208220-7 | 8100634 | 155,95 | |
| 10208220-9 | 8100636 | 232,38 | |

NORDduct - Pyöreä kanavajärjestelmä, galvanoitu
**Tulppa-puhdistusluukku
kanavalle
NALH**

| Koko Ød | Tuotekoodi | LVI-koodi | Hinta €/kpl | kpl/ laatikko |
|------------|-------------|-----------|----------------|------------------|
| 100 | 10208100-1 | 8318500 | 15,26 | 34 |
| 125 | 10208125-1 | 8318501 | 15,50 | 65 |
| 160 | 10208160-1 | 8318502 | 16,07 | 35 |
| 200 | 10208200-1 | 8318503 | 18,46 | 45 |
| 250 | 10208250-1 | 8318504 | 25,36 | 25 |
| 315 | 10208310-1 | 8318505 | 43,00 | 26 |
| 400 | 10208400-1 | 8318506 | 61,79 | 10 |
| 500 | 10208500-1 | 8318507 | 82,92 | 6 |
| 630 | 10208630-1 | 8318508 | 104,05 | 24 |
| 800 | 10208800-1 | 8318509 | 230,78 | 10 |
| 1000 | 102081000-1 | 8318510 | 298,15 | |
| 1250 | 102081250-1 | 8318511 | 417,92 | |

**Tulppa-puhdistusluukku
osalle
NALMH**

| Tuotekoodi | LVI-koodi | Hinta €/kpl | kpl/ laatikko |
|------------|-----------|----------------|------------------|
| 10208100-2 | 8318512 | 13,19 | 50 |
| 10208125-2 | 8318513 | 13,96 | 36 |
| 10208160-2 | 8318514 | 16,47 | 20 |
| 10208200-2 | 8318515 | 19,78 | 30 |
| 10208250-2 | 8318516 | 29,60 | 16 |
| 10208315-2 | 8318517 | 32,95 | 30 |
| 10208400-2 | 8318518 | 75,76 | 8 |
| 10208500-2 | 8318519 | 80,72 | 6 |
| 10208630-2 | 8318520 | 85,70 | 24 |
| 10208800-2 | 8318521 | 156,48 | 10 |
| 10208101-2 | 8318522 | 189,41 | |
| 10208102-2 | 8318523 | 298,24 | |

**Tulppa-puhdistusluukku
kanavalle, paloeristetty
NALHE-EI60**

| Tuotekoodi | LVI-koodi | Hinta €/kpl | kpl/ laatikko |
|-------------|-----------|----------------|------------------|
| 10208100-3 | 8318524 | 40,30 | 21 |
| 10208125-3 | 8318525 | 43,82 | 27 |
| 10208160-3 | 8318526 | 51,01 | 40 |
| 10208200-5 | 8318527 | 55,44 | 20 |
| 10208125-4 | 8318528 | 65,75 | 12 |
| 10208125-6 | 8318529 | 94,10 | 11 |
| 10208400-0 | 8318530 | 115,81 | 8 |
| 10208500-0 | 8318531 | 147,89 | |
| 10208630-0 | 8318532 | 187,30 | |
| 10208800-0 | 8318533 | 290,08 | |
| 102081000-2 | 8318534 | 455,94 | |
| 102081250-2 | 8318535 | 604,50 | |

**Tulppa-puhdistusluukku
osalle, paloeristetty
NALMHE - EI60**

| Koko Ød | Tuotekoodi | LVI-koodi | Hinta €/kpl | kpl/ laatikko |
|------------|-------------|-----------|----------------|------------------|
| 100 | 10208250-8 | 8318536 | 40,30 | 21 |
| 125 | 10208250-9 | 8318537 | 43,82 | 27 |
| 160 | 10208250-10 | 8318538 | 51,01 | 20 |
| 200 | 10208200-3 | 8318539 | 55,44 | 20 |
| 250 | 10208250-4 | 8318540 | 65,75 | 12 |
| 315 | 10208250-7 | 8318541 | 94,10 | 11 |
| 400 | 10208200-10 | 8318542 | 115,81 | 10 |
| 500 | 10208250-11 | 8318543 | 147,89 | 20 |
| 630 | 10208250-12 | 8318544 | 187,30 | |
| 800 | 10208250-13 | 8318545 | 290,08 | |
| 1000 | 10208250-14 | 8318546 | 455,94 | |
| 1250 | 10208250-15 | 8318547 | 604,50 | |

**Liitinpää
MSG**

 Koot Ø 100-315 mm L=50
 Koot Ø 400-1250 mm L=70

| Koko Ød | Tuotekoodi | LVI-koodi | Hinta €/kpl | kpl/ laatikko |
|------------|------------|-----------|----------------|------------------|
| 100-50 | 10225010 | 8105784 | 9,18 | 30 |
| 125-50 | 10225012 | 8105785 | 9,49 | 18 |
| 160-50 | 10225016 | 8105786 | 9,83 | 20 |
| 200-50 | 10225020 | 8105787 | 11,02 | 30 |
| 250-50 | 10225025 | 8105788 | 12,56 | 16 |
| 315-50 | 10225031 | 8105789 | 14,08 | 14 |
| 400-70 | 10225040 | 8105790 | 18,32 | 10 |
| 500-70 | 10225050 | 8105791 | 21,88 | 22 |
| 630-70 | 10225063 | 8105792 | 27,16 | 16 |
| 800-70 | 10225080 | 8105866 | 68,27 | |
| 1000-70 | 10225101 | 8105867 | 98,56 | |
| 1250-70 | 10225122 | 8105868 | 127,97 | |

**Muunto, keskeinen
osa/osa
NFC**

| Koko Ød1-d2 | Tuotekoodi | LVI-koodi | Hinta €/kpl | kpl/ laatikko |
|----------------|------------|-----------|----------------|------------------|
| 125/100 | 10209121-0 | 8100518 | 15,26 | 63 |
| 160/100 | 10209160-1 | 8100520 | 15,55 | 30 |
| 160/125 | 10209161-2 | 8100522 | 16,42 | 35 |
| 200/100 | 10209200-1 | 8100524 | 20,37 | 42 |
| 200/125 | 10209201-2 | 8100526 | 20,89 | 24 |
| 200/160 | 10209201-6 | 8100528 | 23,81 | 24 |
| 250/160 | 10209251-6 | 8100532 | 27,97 | 32 |
| 250/200 | 10209252-0 | 8100534 | 28,00 | 32 |
| 315/160 | 10209311-6 | 8100536 | 34,38 | 17 |
| 315/200 | 10209312-0 | 8100538 | 34,37 | 18 |
| 315/250 | 10209312-5 | 8100540 | 36,20 | 19 |

**Muunto, keskeinen
kanava/osa
NFCM**

| Koko Ød1-d2 | Tuotekoodi | LVI-koodi | Hinta €/kpl | kpl/ laatikko |
|----------------|------------|-----------|----------------|------------------|
| 125/100 | 10279121-0 | 8100428 | 13,53 | 63 |
| 160/100 | 10279160-1 | 8100430 | 13,91 | 35 |
| 160/125 | 10219161-2 | 8100432 | 13,91 | 35 |
| 200/100 | 10279200-1 | 8100434 | 16,76 | 24 |
| 200/125 | 10279201-2 | 8100436 | 16,76 | 28 |
| 200/160 | 10279201-6 | 8100438 | 17,70 | 28 |
| 250/160 | 10279251-6 | 8100444 | 24,02 | 32 |
| 250/200 | 10279252-0 | 8100446 | 24,02 | 36 |
| 315/160 | 10279311-6 | 8100448 | 29,83 | 21 |
| 315/200 | 10279312-0 | 8100450 | 29,83 | 21 |
| 315/250 | 10279312-5 | 8100452 | 29,83 | 21 |

Ilmanvaihtokanavajärjestelmät

NORDduct - Pyöreä kanavajärjestelmä, galvanoitu

**Muunto, keskeinen
osa/osa
NFCV**



| Koko Ød1-d2 | Tuotekoodi | LVI-koodi | Hinta €/kpl | kpl/laatikko |
|-------------|-------------|-----------|-------------|--------------|
| 250/100 | 10209250-2 | 8105803 | 42,93 | 12 |
| 250/125 | 10209251-5 | 8105804 | 44,51 | 22 |
| 315/125 | 10209311-3 | 8100535 | 50,53 | 8 |
| 400/100 | 10209401-7 | 8100543 | 75,44 | |
| 400/125 | 102094012-7 | 8100545 | 75,44 | |
| 400/160 | 10209401-6 | 8100541 | 75,44 | 1 |
| 400/200 | 10209402-0 | 8100542 | 78,94 | 7 |
| 400/250 | 10209402-5 | 8100544 | 80,84 | 8 |
| 400/315 | 10209403-1 | 8100546 | 82,74 | 8 |
| 500/200 | 10209502-0 | 8100554 | 99,61 | 1 |
| 500/250 | 10209502-5 | 8100547 | 99,63 | 10 |
| 500/315 | 10209503-1 | 8100548 | 99,69 | 12 |
| 500/400 | 10209504-0 | 8100549 | 102,84 | 17 |
| 630/160 | 102096316-5 | 8105871 | 113,96 | |
| 630/200 | 102096320-5 | 8105706 | 113,89 | |
| 630/250 | 10209632-5 | 8100555 | 118,49 | 1 |
| 630/315 | 10209633-1 | 8100550 | 124,21 | 1 |
| 630/400 | 10209634-0 | 8100551 | 130,04 | 8 |
| 630/500 | 10209635-0 | 8100552 | 131,59 | 10 |
| 800/315 | 10209807-3 | 8105707 | 257,64 | |
| 800/400 | 10209807-0 | 8105708 | 257,77 | |
| 800/500 | 10209809-0 | 8105709 | 259,51 | |
| 800/630 | 10209806-0 | 8105710 | 328,30 | |
| 1000/315 | 102091000-2 | 8105872 | 379,34 | |
| 1000/400 | 102091000-4 | 8105711 | 379,28 | |
| 1000/500 | 102091000-5 | 8105712 | 378,74 | |
| 1000/630 | 102091000-6 | 8105713 | 387,49 | |
| 1000/800 | 102091000 | 8105714 | 396,12 | |
| 1250/500 | 110129054 | 8105807 | 623,89 | |
| 1250/630 | 110129055 | 8105808 | 645,09 | |
| 1250/800 | 102090800 | 8105715 | 649,71 | |
| 1250/1000 | 102091250 | 8105716 | 649,69 | |

**Muunto, keskeinen
kanava/osa
NFCVM**



| Koko ØD-d2 | Tuotekoodi | LVI-koodi | Hinta €/kpl | kpl/laatikko |
|------------|------------|-----------|-------------|--------------|
| 250/100 | 10279250-2 | 8105771 | 44,05 | |
| 250/125 | 10279251-3 | 8105772 | 44,08 | |
| 250/160 | 10279251-7 | 8105773 | 45,19 | |
| 250/200 | 10279252-1 | 8105774 | 46,38 | |
| 315/125 | 10279311-3 | 8105775 | 52,00 | |
| 315/160 | 10279311-7 | 8105776 | 33,78 | |
| 400/160 | 10279401-6 | 8105779 | 70,95 | |
| 400/200 | 10279402-0 | 8105780 | 72,57 | 7 |
| 400/250 | 10279402-5 | 8105781 | 72,55 | 8 |
| 400/315 | 10279403-1 | 8105782 | 72,56 | 9 |
| 500/200 | 10279502-0 | 8103230 | 91,69 | |
| 500/250 | 10279502-5 | 8103231 | 98,24 | |
| 500/315 | 10279503-1 | 8103232 | 98,17 | 16 |
| 500/400 | 10279504-0 | 8103233 | 98,23 | 16 |
| 630/250 | 10279632-5 | 8103238 | 117,45 | |
| 630/315 | 10279633-1 | 8103239 | 119,80 | |
| 630/400 | 10279634-0 | 8103240 | 119,83 | 8 |
| 630/500 | 10279635-0 | 8103241 | 119,84 | 7 |
| 800/400 | 110131037 | 8105810 | 233,82 | |
| 800/500 | 110131038 | 8105811 | 233,74 | |
| 800/630 | 10279806-0 | 8105783 | 233,85 | |
| 1000/400 | 110131039 | 8105812 | 242,65 | |
| 1000/500 | 110131040 | 8105813 | 242,59 | |
| 1000/630 | 110131041 | 8105814 | 242,64 | |
| 1000/800 | 110131042 | 8105815 | 244,40 | |
| 1250/500 | 110131043 | 8105816 | 364,77 | |
| 1250/630 | 110131044 | 8105817 | 386,83 | |
| 1250/800 | 110131045 | 8105818 | 386,85 | |
| 1250/1000 | 110131046 | 8105819 | 404,35 | |

**Muunto, epäkeskeinen
kanava/osa
NFBM**



| Koko ØD-d2 | Tuotekoodi | LVI-koodi | Hinta €/kpl |
|------------|------------|-----------|-------------|
| 125/100 | 10289125-0 | 8100464 | 33,68 |
| 160/100 | 10289160-0 | 8100465 | 34,83 |
| 160/125 | 10289101-0 | 8100466 | 35,46 |
| 200/100 | 10289201 | 8100467 | 37,97 |
| 200/125 | 10289201-5 | 8100468 | 39,00 |
| 200/160 | 10289201-1 | 8100469 | 40,21 |
| 250/100 | 10289252-2 | 8100470 | 48,24 |
| 250/125 | 102892512 | 8100471 | 48,89 |
| 250/160 | 102892516 | 8100472 | 51,46 |
| 250/200 | 10289252-1 | 8100473 | 51,46 |
| 315/125 | 110133012 | 8100475 | 58,04 |
| 315/160 | 10289312-2 | 8100476 | 59,00 |
| 315/200 | 10289320 | 8100477 | 58,97 |
| 315/250 | 10289312-1 | 8100478 | 59,92 |
| 400/160 | 110133018 | 8100479 | 76,69 |
| 400/200 | 10289402-2 | 8100480 | 78,51 |
| 400/250 | 10289415-2 | 8100482 | 78,49 |
| 400/315 | 10289403-0 | 8100484 | 90,27 |
| 500/200 | 110133025 | 8100485 | 102,05 |
| 500/250 | 10289503-2 | 8100486 | 100,91 |
| 500/315 | 10289503-0 | 8100488 | 100,95 |
| 500/400 | 10289504-1 | 8100490 | 98,13 |
| 630/250 | 10289632-0 | 8100491 | 122,22 |
| 630/315 | 10289633-0 | 8100492 | 124,25 |
| 630/400 | 10289633-4 | 8100494 | 125,39 |
| 630/500 | 10289635-1 | 8100496 | 122,37 |
| 800/315 | 10289803-1 | 8100497 | 236,50 |
| 800/400 | 10289804-0 | 8100498 | 236,50 |
| 800/500 | 10289805-0 | 8100500 | 236,51 |
| 800/630 | 10289806-0 | 8100501 | 240,17 |
| 1000/500 | 10289105-0 | 8100502 | 379,01 |
| 1000/630 | 10289106-3 | 8100503 | 379,04 |
| 1000/800 | 10289108-0 | 8100504 | 390,36 |
| 1250/630 | 10289156-3 | 8100505 | 632,75 |
| 1250/800 | 10289158-0 | 8100506 | 636,07 |
| 1250/1000 | 10289151-0 | 8100508 | 714,19 |

**Muunto, epäkeskeinen
osa/osa
NFB**



| Koko Ød1-d2 | Tuotekoodi | LVI-koodi | Hinta €/kpl | kpl/laatikko | Koko Ød1-d2 | Tuotekoodi | LVI-koodi | Hinta €/kpl | kpl/laatikko | Koko Ød1-d2 | Tuotekoodi | LVI-koodi | Hinta €/kpl |
|-------------|--------------|-----------|-------------|--------------|-------------|-------------|-----------|-------------|--------------|-------------|-------------|-----------|-------------|
| 125/100 | 10209101-1 | 8100556 | 36,79 | 18 | 400/125 | 10209412-1 | 8105820 | 75,11 | | 630/500 | 10209635-1 | 8100588 | 125,27 |
| 160/100 | 10209101-3 | 8100557 | 38,15 | 10 | 400/160 | 10209412-2 | 8100571 | 76,70 | 4 | 800/315 | 10209803-1 | 8100589 | 254,54 |
| 160/125 | 10209101-0 | 8100558 | 38,20 | 16 | 400/200 | 10209402-2 | 8100572 | 76,68 | 5 | 800/400 | 10209804-0 | 8100590 | 254,54 |
| 200/125 | 102092012-1 | 8100560 | 35,62 | 6 | 400/250 | 10209415-2 | 8100574 | 77,64 | 6 | 800/500 | 10209805-0 | 8100592 | 274,16 |
| 200/160 | 10209201-1 | 8100561 | 35,60 | 15 | 400/315 | 10209403-0 | 8100576 | 78,56 | 7 | 800/630 | 10209806-3 | 8100594 | 326,59 |
| 250/100 | 10209251-3 | 8100562 | 42,36 | 10 | 500/200 | 102095200-2 | 8100577 | 86,71 | 8 | 1000/400 | 110132049 | 8100595 | 376,60 |
| 250/125 | 10209251-4 | 8100563 | 43,72 | 10 | 500/250 | 10209503-2 | 8100578 | 99,12 | 10 | 1000/500 | 102091000-3 | 8100596 | 376,54 |
| 250/160 | 10209251-1 | 8100564 | 44,49 | 12 | 500/315 | 10209503-0 | 8100580 | 101,05 | 12 | 1000/630 | 10209106-3 | 8100598 | 385,27 |
| 250/200 | 10209252-1 | 8100565 | 44,47 | 12 | 500/400 | 10209504-1 | 8100582 | 102,27 | 16 | 1000/800 | 10209108-0 | 8100600 | 393,96 |
| 315/125 | 1020931125-1 | 8100567 | 49,85 | 8 | 630/200 | 10209620-0 | 8105824 | 109,26 | | 1250/630 | 10209156-3 | 8100602 | 635,32 |
| 315/160 | 1020931160-1 | 8100568 | 49,66 | 8 | 630/250 | 10209625-0 | 8100583 | 114,10 | 4 | 1250/800 | 10209158-0 | 8100604 | 642,11 |
| 315/200 | 102093120-1 | 8100569 | 49,69 | 9 | 630/315 | 10209633-0 | 8100584 | 129,34 | 10 | 1250/1000 | 10209151-0 | 8100606 | 646,13 |
| 315/250 | 1020931250-1 | 8100570 | 50,77 | 10 | 630/400 | 10209633-4 | 8100586 | 129,31 | 8 | | | | |

NORDduct - Pyöreä kanavajärjestelmä, galvanoitu
**Lähtökaulus
NPS**

| Koko ØD-d | Tuotekoodi | LVI-koodi | Hinta €/kpl | kpl/ laatikko | | Koko ØD-d | Tuotekoodi | LVI-koodi | Hinta €/kpl | kpl/ laatikko | |
|-----------|------------|-----------|-------------|---------------|---|-----------|------------|-----------|-------------|---------------|---|
| 100/100 | 10206010-1 | 8100288 | 9,45 | 80 | • | 315/200 | 10206312-0 | 8100332 | 19,36 | 32 | • |
| 125/100 | 10206120-1 | 8100292 | 9,79 | 80 | • | 315/250 | 10206312-5 | 8100334 | 25,63 | 24 | • |
| 125/125 | 10206121-2 | 8100294 | 10,33 | 40 | • | 315/315 | 10206313-1 | 8100336 | 33,08 | 60 | • |
| 160/100 | 10206160-1 | 8100298 | 10,49 | 90 | • | 400/100 | 10206400-1 | 8100338 | 16,96 | 50 | • |
| 160/125 | 10206161-2 | 8100300 | 11,33 | 50 | • | 400/125 | 10206401-2 | 8100340 | 17,80 | 75 | • |
| 160/160 | 10206161-6 | 8100302 | 14,92 | 22 | • | 400/160 | 10206401-6 | 8100342 | 18,73 | 60 | • |
| 200/100 | 10206200-1 | 8100306 | 10,00 | 90 | • | 400/200 | 10206402-0 | 8100344 | 24,59 | 36 | • |
| 200/125 | 10206201-2 | 8100308 | 10,50 | 52 | • | 400/250 | 10206402-5 | 8100346 | 25,60 | 24 | • |
| 200/160 | 10206201-6 | 8100310 | 14,97 | 25 | • | 400/315 | 10206403-1 | 8100348 | 30,85 | 60 | • |
| 200/200 | 10206202-0 | 8100312 | 20,63 | 32 | • | 500/100 | 10206400-1 | 8100338 | 16,96 | 50 | • |
| 250/100 | 10206250-1 | 8100316 | 11,87 | 90 | • | 500/125 | 10206401-2 | 8100340 | 17,80 | 75 | • |
| 250/125 | 10206251-2 | 8100318 | 12,70 | 50 | • | 500/160 | 10206501-6 | 8100356 | 27,02 | 40 | • |
| 250/160 | 10206251-6 | 8100320 | 13,41 | 36 | • | 500/200 | 10206502-3 | 8100358 | 35,55 | 38 | • |
| 250/200 | 10206252-0 | 8100322 | 20,52 | 32 | • | 500/250 | 10206502-1 | 8100360 | 47,82 | 22 | • |
| 250/250 | 10206252-5 | 8100324 | 24,62 | 20 | • | 500/315 | 10206503-3 | 8100362 | 50,11 | 13 | • |
| 315/100 | 10206310-1 | 8100326 | 14,95 | 100 | • | 630/200 | 10206632-1 | 8100374 | 35,74 | 38 | • |
| 315/125 | 10206311-2 | 8100328 | 16,86 | 54 | • | 630/250 | 10206632-2 | 8100376 | 43,01 | 22 | • |
| 315/160 | 10206311-6 | 8100330 | 18,73 | 32 | • | 630/315 | 10206633-2 | 8100378 | 57,72 | 13 | • |

**Lähtökaulus,
lyhyt kaulus
NPSK**

| Koko ØD-d | Tuotekoodi | LVI-koodi | Hinta €/kpl | kpl/ laatikko | | Koko ØD-d | Tuotekoodi | LVI-koodi | Hinta €/kpl | kpl/ laatikko | |
|-----------|------------|-----------|-------------|---------------|---|-----------|-------------|-----------|-------------|---------------|---|
| 160/125 | 10206161-3 | 8105717 | 37,74 | | | 630/500 | 10206635-K | 8105744 | 96,99 | | • |
| 160/160 | 10206161-1 | 8105718 | 39,56 | | | 630/630 | 102066363 | 8105745 | 190,92 | 10 | • |
| 200/160 | 10206202-K | 8105719 | 41,39 | | | 800/160 | 10206831-6 | 8105746 | 55,57 | | • |
| 200/200 | 10206203-K | 8105720 | 43,18 | | | 800/200 | 10206802-0 | 8105747 | 59,43 | | • |
| 250/160 | 10206251-K | 8105721 | 45,02 | | | 800/250 | 10206802-5 | 8105748 | 69,83 | 10 | • |
| 250/200 | 10206252-1 | 8105722 | 46,82 | | | 800/315 | 10206803-1 | 8105749 | 80,50 | 10 | • |
| 250/250 | 102062525 | 8105723 | 50,39 | | | 800/400 | 10206804-K | 8105750 | 87,68 | 10 | • |
| 315/160 | 110135018 | 8105724 | 55,48 | | | 800/500 | 102068050 | 8105751 | 97,06 | 20 | • |
| 315/200 | 102063120 | 8105725 | 57,48 | | | 800/630 | 10206806-K | 8105752 | 190,90 | 14 | • |
| 315/250 | 102063125 | 8105726 | 69,90 | | | 800/800 | 102068080 | 8105753 | 190,94 | 5 | • |
| 315/315 | 102063131 | 8105727 | 80,45 | | | 1000/200 | 10206103-2 | 8105754 | 55,62 | | • |
| 400/160 | 102064016 | 8105728 | 55,50 | | | 1000/250 | 10206103-4 | 8105755 | 69,84 | | • |
| 400/200 | 102064020 | 8105729 | 59,38 | | | 1000/315 | 10206103-1 | 8105756 | 80,52 | 8 | • |
| 400/250 | 102064025 | 8105730 | 69,93 | | | 1000/400 | 102061040 | 8105757 | 87,64 | 10 | |
| 400/315 | 10206403-K | 8105731 | 80,44 | 10 | | 1000/500 | 102061050 | 8105758 | 97,11 | | |
| 400/400 | 10206404-K | 8105732 | 87,62 | 6 | • | 1000/630 | 102061063 | 8105759 | 203,51 | | |
| 500/160 | 102065016 | 8105733 | 55,56 | | | 1000/800 | 10206108-1 | 8105760 | 203,57 | | |
| 500/200 | 10206502-0 | 8105734 | 59,32 | 35 | | 1000/1000 | 102061010 | 8105761 | 324,35 | | |
| 500/250 | 10206502-5 | 8105735 | 69,96 | 24 | | 1250/200 | 102061520-0 | 8105762 | 55,66 | | |
| 500/315 | 10206503-1 | 8105736 | 80,40 | | | 1250/250 | 102061525-0 | 8105763 | 69,93 | | |
| 500/400 | 10206504-K | 8105737 | 87,67 | 10 | • | 1250/315 | 10206153-0 | 8105764 | 80,42 | | |
| 500/500 | 10206505-K | 8105738 | 97,03 | 18 | • | 1250/400 | 10206154-0 | 8105765 | 87,65 | | |
| 630/160 | 10206631-6 | 8105739 | 55,59 | 16 | | 1250/500 | 10206155-0 | 8105766 | 96,98 | | |
| 630/200 | 10206632-0 | 8105740 | 59,34 | 10 | | 1250/630 | 102061563 | 8105767 | 203,70 | | |
| 630/250 | 10206632-5 | 8105741 | 69,88 | 24 | | 1250/800 | 10206168-1 | 8105768 | 203,53 | | |
| 630/315 | 10206633-1 | 8105742 | 80,45 | | | 1250/1000 | 102061510 | 8105769 | 324,29 | | |
| 630/400 | 10206634-K | 8105743 | 87,60 | 10 | • | 1250/1250 | 102061512 | 8105770 | 324,35 | | |

Ilmanvaihtokanavajärjestelmät

NORDduct - Pyöreä kanavajärjestelmä, galvanoitu

Lähtökaulus NPSV



| Koko ØD-d | Tuotekoodi | LVI-koodi | Hinta €/kpl | kpl/laatikko | |
|-----------|------------|-----------|-------------|--------------|---|
| 400/400 | 10206404-0 | 8100350 | 81,26 | 16 | • |
| 500/400 | 10206504-0 | 8100364 | 88,31 | 16 | • |
| 500/500 | 10206505-0 | 8100366 | 103,16 | 14 | • |
| 630/400 | 10206634-0 | 8100380 | 91,35 | 16 | • |
| 630/500 | 10206635-0 | 8100382 | 116,25 | 8 | • |
| 630/630 | 10206636-3 | 8100384 | 153,27 | 5 | • |
| 800/400 | 10206804-0 | 8100390 | 116,23 | | • |
| 800/500 | 10206805-0 | 8100392 | 136,41 | | • |
| 800/630 | 10206806-3 | 8100394 | 176,05 | | • |
| 800/800 | 10206808-0 | 8100396 | 228,22 | | • |
| 1000/400 | 10206104-0 | 8100397 | 182,13 | | • |
| 1000/500 | 10206105-0 | 8100398 | 198,16 | | • |
| 1000/630 | 10206106-3 | 8100400 | 228,11 | | • |
| 1000/800 | 10206108-0 | 8100402 | 333,78 | | • |
| 1000/1000 | 10206102-0 | 8100404 | 411,23 | | • |
| 1250/400 | 10206168-4 | 8100419 | 403,79 | 10 | |
| 1250/500 | 10206168-5 | 8100405 | 413,71 | 7 | |
| 1250/630 | 10206156-3 | 8100406 | 425,34 | | |
| 1250/800 | 10206168-0 | 8100408 | 430,78 | | |
| 1250/1000 | 10206151-0 | 8100410 | 468,64 | | |
| 1250/1250 | 10206151-5 | 8100412 | 648,36 | | |

T-yhde NTKV



| Koko Ød1-d2 | Tuotekoodi | LVI-koodi | Hinta €/kpl | kpl/laatikko | |
|-------------|-------------|-----------|-------------|--------------|---|
| 400/400 | 10207404-0 | 8100240 | 146,38 | 4 | • |
| 500/400 | 10207636-6 | 8100246 | 202,23 | 2 | • |
| 500/500 | 10207636-7 | 8100248 | 219,06 | 2 | • |
| 630/400 | 10207504-9 | 8100252 | 276,46 | | • |
| 630/500 | 10207504-3 | 8100254 | 299,24 | | • |
| 630/630 | 10207504-4 | 8100256 | 342,40 | | • |
| 800/400 | 10207508-4 | 8100258 | 432,97 | 2 | |
| 800/500 | 10207508-5 | 8100260 | 451,46 | | |
| 800/630 | 10207508-6 | 8100262 | 603,30 | 2 | |
| 800/800 | 10207509-1 | 8100264 | 690,61 | | • |
| 1000/400 | 10207508-1 | 8103189 | 772,62 | | |
| 1000/500 | 10207508-7 | 8100266 | 780,65 | | |
| 1000/630 | 10207508-8 | 8100268 | 920,21 | | |
| 1000/800 | 10207508-80 | 8100270 | 1075,45 | | |
| 1000/1000 | 10207508-9 | 8100272 | 1274,94 | | |
| 1250/400 | 110138039 | 8103191 | 1033,17 | | |
| 1250/500 | 110138040 | 8103192 | 1153,33 | | |
| 1250/630 | 10207510 | 8100274 | 1277,90 | | |
| 1250/800 | 10207509-9 | 8100275 | 1363,48 | | |
| 1250/1000 | 10207121-1 | 8100276 | 1450,57 | | |
| 1250/1250 | 10207121-5 | 8100277 | 1595,66 | | |

T-yhde NTK

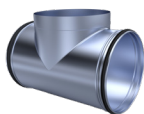

| Koko Ød1-d2 | Tuotekoodi | LVI-koodi | Hinta €/kpl | kpl/laatikko | | Koko Ød1-d2 | Tuotekoodi | LVI-koodi | Hinta €/kpl | kpl/laatikko | |
|-------------|-------------|-----------|-------------|--------------|---|-------------|-------------|-----------|-------------|--------------|---|
| 100/100 | 10207010-1 | 8100184 | 25,28 | 30 | • | 400/100 | 102074010 | 8103173 | 89,13 | | |
| 125/100 | 10207120-1 | 8100188 | 26,61 | 24 | • | 400/125 | 10207401-5 | 8103174 | 91,04 | 10 | |
| 125/125 | 10207121-2 | 8100190 | 28,77 | 28 | • | 400/160 | 102074016-1 | 8103175 | 92,95 | 10 | • |
| 160/100 | 10207160-1 | 8100194 | 28,59 | 21 | • | 400/200 | 102074020-0 | 8100234 | 94,82 | 9 | • |
| 160/125 | 10207161-2 | 8100196 | 29,91 | 18 | • | 400/250 | 10207402-0 | 8100236 | 102,72 | 6 | • |
| 160/160 | 10207161-6 | 8100198 | 35,46 | 16 | • | 400/315 | 10207404-1 | 8100238 | 114,38 | 6 | • |
| 200/100 | 10207200-1 | 8100202 | 34,42 | 12 | • | 500/100 | 110137029 | 8103176 | 109,17 | | |
| 200/125 | 10207201-2 | 8100204 | 37,67 | 12 | • | 500/125 | 10207635-0 | 8103177 | 127,09 | 4 | |
| 200/160 | 10207201-6 | 8100206 | 40,58 | 36 | • | 500/160 | 10207635-1 | 8103178 | 127,09 | 2 | |
| 200/200 | 10207202-0 | 8100208 | 46,57 | 36 | • | 500/200 | 10207635-2 | 8103179 | 130,25 | 2 | |
| 250/100 | 10207252-2 | 8100212 | 42,44 | 6 | • | 500/250 | 10207635-3 | 8100242 | 138,11 | 2 | • |
| 250/125 | 10207252-1 | 8100214 | 44,34 | 6 | • | 500/315 | 10207636-3 | 8100244 | 143,83 | 2 | • |
| 250/160 | 10207256-1 | 8100216 | 49,45 | 24 | • | 630/100 | 110137037 | 8103180 | 147,12 | 3 | |
| 250/200 | 10207252-4 | 8100218 | 56,33 | 22 | • | 630/125 | 10207160-2 | 8103181 | 150,60 | 3 | |
| 250/250 | 10207252-5 | 8100220 | 73,81 | 18 | • | 630/160 | 10207160-3 | 8103182 | 163,02 | | |
| 315/100 | 10207312-01 | 8100222 | 58,76 | 20 | | 630/200 | 10207160-4 | 8103183 | 170,25 | 2 | |
| 315/125 | 10207312-0 | 8100224 | 60,94 | 4 | • | 630/250 | 10207504-7 | 8103184 | 178,94 | 2 | |
| 315/160 | 10207312-5 | 8100226 | 62,48 | 4 | • | 630/315 | 10207503-9 | 8100250 | 185,17 | 2 | |
| 315/200 | 10207312-1 | 8100228 | 65,57 | 14 | • | 800/250 | 110137044 | 8103185 | 341,63 | | |
| 315/250 | 10207312-2 | 8100230 | 78,38 | 12 | • | 800/315 | 10207315-4 | 8103186 | 348,38 | | |
| 315/315 | 10207313-1 | 8100232 | 97,85 | 8 | • | | | | | | |

NORDduct - Pyöreä kanavajärjestelmä, galvanoitu
**T-yhde
NTKM**

| Koko Ød-D | Tuotekoodi | LVI-koodi | Hinta €/kpl | kpl/laatikko |
|-----------|------------|-----------|-------------|--------------|
| 100/100 | 110137101 | 8105893 | 34,09 | 30 |
| 125/100 | 110137102 | 8105894 | 35,97 | 24 |
| 125/125 | 110137103 | 8105895 | 43,46 | 28 |
| 160/100 | 110137104 | 8105896 | 40,38 | 21 |
| 160/125 | 110137105 | 8105897 | 45,24 | 18 |
| 160/160 | 110137106 | 8105898 | 54,80 | 16 |

**Imukartio suojaverkolla
NK**

| Koko Ød | Tuotekoodi | LVI-koodi | Hinta €/kpl | kpl/laatikko |
|---------|------------|-----------|-------------|--------------|
| 100 | H10206100 | 8740100 | 68,20 | 20 |
| 125 | H10206125 | 8740101 | 69,65 | 12 |
| 160 | H10206160 | 8740102 | 70,21 | 6 |
| 200 | H10206200 | 8740103 | 75,59 | 12 |
| 250 | H10206250 | 8740104 | 79,19 | 8 |
| 315 | H10206315 | 8740105 | 102,64 | 8 |
| 400 | H10206400 | 8740106 | 113,40 | 16 |
| 500 | H10206500 | 8740107 | 131,11 | 12 |
| 630 | H10206630 | 8740108 | 162,41 | 7 |
| 800 | H10206800 | 8740109 | 238,54 | |
| 1000 | H102061000 | 8740110 | 332,08 | |
| 1250 | H102061250 | 8740111 | 538,03 | |

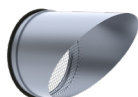
**Viisto imupää verkolla
NP**

| Koko Ød | Tuotekoodi | LVI-koodi | Hinta €/kpl | kpl/laatikko |
|---------|------------|-----------|-------------|--------------|
| 100 | 10215010 | 8105882 | 60,78 | |
| 125 | 10215120 | 8105883 | 68,67 | 18 |
| 160 | 10215160 | 8105884 | 75,08 | 14 |
| 200 | 10215200 | 8105885 | 83,43 | 14 |
| 250 | 10215250 | 8105886 | 108,18 | 8 |
| 315 | 10215310 | 8105887 | 131,93 | 4 |
| 400 | 10215400 | 8105888 | 146,02 | |
| 500 | 10215500 | 8105889 | 188,91 | |
| 630 | 10215630 | 8105838 | 289,96 | |
| 800 | 10215800 | 8105839 | 382,85 | |
| 1000 | 102151000 | 8105840 | 475,73 | |
| 1250 | 102151250 | 8105841 | 618,19 | |

**Imupää suojaverkolla
NG**

| Koko Ød | Tuotekoodi | LVI-koodi | Hinta €/kpl |
|---------|-------------|-----------|-------------|
| 100 | 8600201100 | 8105873 | 26,53 |
| 125 | 8600201125 | 8105874 | 31,51 |
| 160 | 8600201160 | 8105875 | 33,39 |
| 200 | 8600201200 | 8105876 | 36,58 |
| 250 | 8600201250 | 8105877 | 55,06 |
| 315 | 8600201315 | 8105878 | 64,11 |
| 400 | 8600201400 | 8105879 | 78,29 |
| 500 | 8600201500 | 8105880 | 93,40 |
| 630 | 8600201630 | 8105881 | 123,40 |
| 800 | 8600201800 | 8105827 | 176,78 |
| 1000 | 8600201900 | 8105828 | 247,49 |
| 1250 | 86002011250 | 8105829 | 341,60 |

**Ristiinmenokappale
NTL**

| Koko Ød-L | Tuotekoodi | LVI-koodi | Hinta €/kpl | kpl/laatikko |
|-----------|------------|-----------|-------------|--------------|
| 100-500 | 8300000210 | 8105700 | 111,40 | 48 |
| 100-690 | 8300000217 | 8105701 | 118,82 | 36 |
| 125-500 | 830000025 | 8105702 | 116,12 | 40 |
| 125-690 | 8300000257 | 8105703 | 129,83 | 30 |
| 125-800 | 8300000258 | 8106105 | 144,00 | 24 |
| 160-600 | 8300000216 | 8105704 | 133,60 | 16 |
| 160-800 | 8300000218 | 8106106 | 146,27 | 14 |
| 160-900 | 8300000219 | 8105705 | 151,81 | 10 |
| 200-500 | 8300000221 | 8106103 | 184,65 | |
| 200-800 | 8300000220 | 8106102 | 189,52 | |
| 200-900 | 8300000222 | 8106104 | 210,12 | |

**Saunakanava
TS**

L=2400 mm

| Koko Ød | Tuotekoodi | LVI-koodi | Hinta €/kpl | kpl/laatikko |
|------------|------------|-----------|-------------|--------------|
| 100-145x45 | 8610767646 | 8268370 | 94,78 | 50 |
| 125-170x45 | 8610767648 | 8268371 | 116,00 | 40 |

2. NORDdoor – Puhdistusluukut

Puhdistusluukku pyöreälle TL3

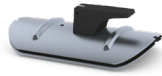

| Koko ØD | Tuotekoodi | LVI-koodi | Hinta €/kpl | kpl/laatikko |
|---------|------------|-----------|-------------|--------------|
| 100 | 10114011-2 | 8318827 | 30,46 | 10 |
| 125 | 10114012-2 | 8318828 | 30,46 | 10 |
| 160 | 10114016-2 | 8318829 | 30,46 | 10 |
| 200 | 10113020-2 | 8318830 | 53,12 | 10 |
| 250 | 10114025-2 | 8318831 | 53,12 | 10 |
| 315 | 10114031-2 | 8318832 | 53,12 | 10 |
| 400 | 10114126-2 | 8318833 | 75,30 | 5 |
| 500 | 10115126-2 | 8318834 | 75,30 | 5 |
| 630 | 10116126-2 | 8318835 | 146,28 | 5 |
| 800 | 10116226-2 | 8318836 | 146,28 | 5 |
| 1000 | 10116227-2 | 8318837 | 146,28 | 5 |
| 1250 | 10116228-2 | 8318838 | 154,86 | 5 |

Puhdistusluukku, kanavaosa TLN3



| Tuotekoodi | LVI-koodi | Hinta €/kpl | kpl/laatikko |
|------------|-----------|-------------|--------------|
| 10114011-4 | 8318839 | 110,10 | 6 |
| 10114012-4 | 8318840 | 113,06 | 9 |
| 10114016-4 | 8318841 | 116,05 | 5 |
| 10113020-4 | 8318842 | 130,93 | 3 |
| 10114025-4 | 8318843 | 156,20 | 3 |
| 10114031-4 | 8318844 | 159,19 | 2 |
| 10114126-4 | 8318845 | 209,77 | 4 |
| 10115126-4 | 8318846 | 233,58 | |
| 10116126-4 | 8318847 | 313,93 | |
| 10116226-4 | 8318597 | 419,57 | |
| 10116227-4 | 8318598 | 488,01 | |

Puhdistusluukku pyöreälle, paloeristetty (80 mm) TLPE-EI60



Aukko
100...160 – 200x100
200...500 – 400x200
630...1250 – 500x400

| Tuotekoodi | LVI-koodi | Hinta €/kpl |
|-------------|-----------|-------------|
| 10114020-12 | 8318557 | 234,86 |
| 10114012-11 | 8318558 | 234,86 |
| 10114016-11 | 8318559 | 234,86 |
| 10114020-11 | 8318560 | 331,04 |
| 10114020-14 | 8318561 | 331,04 |
| 10114031-11 | 8318562 | 331,04 |
| 10114126-11 | 8318563 | 331,04 |
| 10115126-0 | 8318564 | 331,04 |
| 10116127-4 | 8318565 | 447,04 |
| 10116226-9 | 8318566 | 492,00 |
| 10116227-5 | 8318567 | 491,92 |
| 10114126-12 | 8318568 | 613,33 |

Puhdistusluukku pyöreälle TPL

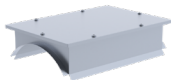

Aukko
200...315 – 200x100
400...500 – 300x200
630...800 – 400x300

| Koko Ød | Tuotekoodi | LVI-koodi | Hinta €/kpl |
|---------|-------------|-----------|-------------|
| 125 | | | |
| 160 | | | |
| 200 | 10114215-2 | 8318773 | 296,06 |
| 250 | 10114215-21 | 8318774 | 296,06 |
| 315 | 10114215-22 | 8318775 | 296,06 |
| 400 | 10114202-2 | 8318776 | 308,91 |
| 500 | 10114202-21 | 8318777 | 308,91 |
| 630 | 10114203-2 | 8318778 | 320,26 |
| 800 | 10114203-21 | 8318779 | 320,26 |

Puhdistusluukku pyöreälle, paloeristetty (80 mm) TPLE EI60

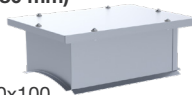

Aukko
125...315 – 200x100
400...500 – 300x200
630...800 – 400x300

| Tuotekoodi | LVI-koodi | Hinta €/kpl |
|-------------|-----------|-------------|
| 10114215-4 | 8318548 | 187,86 |
| 10114215-16 | 8318549 | 187,86 |
| 10114215-3 | 8318550 | 187,86 |
| 10114215-31 | 8318551 | 187,86 |
| 10114215-32 | 8318552 | 187,86 |
| 10114202-3 | 8318553 | 200,85 |
| 10114202-31 | 8318554 | 200,85 |
| 10114203-3 | 8318555 | 227,98 |
| 10114203-31 | 8318556 | 227,98 |

Puhdistusluukku tasopinnalle TL1



| Koko AxB | Tuotekoodi | LVI-koodi | Hinta €/kpl | kpl/laatikko |
|----------|------------|-----------|-------------|--------------|
| 300x200 | 10113002-2 | 8318732 | 99,19 | 5 |
| 400x200 | 10114202-4 | 8318733 | 110,34 | 5 |
| 500x400 | 10114203-4 | 8318734 | 172,42 | 5 |

Puhdistusluukku tasopinnalle TLT

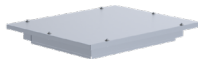

| Koko AxB | Tuotekoodi | LVI-koodi | Hinta €/kpl |
|----------|------------|-----------|-------------|
| 300x200 | 10113002 | 8318590 | 215,65 |
| 300x300 | 10113003 | 8318591 | 215,65 |
| 400x100 | 10114201 | 8318592 | 215,65 |
| 400x200 | 10114202 | 8318569 | 215,65 |
| 500x200 | 10114205 | 8318593 | 235,90 |
| 500x400 | 10114203 | 8318570 | 235,90 |
| 600x300 | 10114207 | 8318594 | 249,84 |
| 600x400 | 10114206 | 8318595 | 265,73 |
| 600x500 | 10114204 | 8318596 | 265,73 |

Puhdistusluukku tasopinnalle, lämpö- tai paloeristetty TLTE

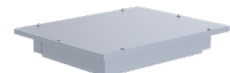

EI30 (60 mm)
EI60 (100 mm)

| Koko AxB | Tuotekoodi | LVI-koodi | Hinta €/kpl |
|---------------|-------------|-----------|-------------|
| 200x100-EI30 | 10114215-30 | 8318780 | 223,00 |
| 400x200-EI30 | 10114202-30 | 8318781 | 229,94 |
| 400x300-EI30 | 10114203-30 | 8318782 | 262,02 |
| 500x400-EI30 | 10114204-30 | 8318783 | 289,90 |
| 200x100-EI60 | 10114215-60 | 8318784 | 226,47 |
| 400x200-EI60 | 10114202-60 | 8318785 | 289,90 |
| 400x300 EI60 | 10114203-60 | 8318786 | 273,17 |
| 500x400 EI60 | 10114204-60 | 8318787 | 376,30 |
| 200x100-LE 50 | 10114215-50 | 8318788 | 289,90 |
| 400x200-LE 50 | 1011442050 | 8318789 | 283,49 |
| 400x300-LE 50 | 10114203-50 | 8318790 | 298,25 |
| 500x400-LE 50 | 10114204-50 | 8318791 | 354,72 |

3. NORDdamper – Sääto- ja sulkupellit

Säätopeleti KRI



| Koko Ød | Tuote-koodi | LVI-koodi | Hinta €/kpl | kpl/ laatikko |
|---------|-------------|-----------|-------------|---------------|
| 100 | 6200100A | 8416700 | 36,05 | 252 |
| 125 | 6200125A | 8416701 | 42,47 | 175 |
| 160 | 6200160A | 8416702 | 60,07 | 100 |
| 200 | 6200200A | 8416703 | 65,10 | 68 |
| 250 | 6200250A | 8416704 | 95,66 | 54 |
| 315 | 6200315A | 8416705 | 121,01 | 24 |
| 400 | 6200400A | 8417161 | 233,26 | 20 |
| 500 | 6200500A | 8417162 | 366,61 | 14 |
| 630 | 6200630A | 8417163 | 554,85 | 6 |
| 800 | 6200800A | 8417164 | 1188,97 | 3 |

Säätopeleti KROS



| Tuote-koodi | LVI-koodi | Hinta €/kpl | kpl/ laatikko |
|-------------|-----------|-------------|---------------|
| 6210100 | 8406466 | 30,42 | 50 |
| 6210125 | 8406467 | 31,90 | 30 |
| 6210160 | 8406468 | 33,77 | 20 |
| 6210200 | 8406469 | 42,22 | 23 |
| 6210250 | 8406470 | 54,77 | 45 |
| 6210315 | 8406471 | 63,90 | 25 |
| 6210400 | 8406472 | 129,78 | 24 |
| 6210500 | 8406473 | 157,87 | 6 |
| 6210630 | 8417151 | 183,12 | 6 |

Sääto- ja sulkupeliti, tiivistetty KRTS-4



| Tuote-koodi | LVI-koodi | Hinta €/kpl | kpl/ laatikko |
|-------------|-----------|-------------|---------------|
| 6210100-3 | 8417152 | 84,79 | 12 |
| 6210125-3 | 8417153 | 88,13 | 24 |
| 6210160-3 | 8417154 | 90,84 | 15 |
| 6210200-3 | 8417155 | 96,68 | 15 |
| 6210250-3 | 8417156 | 107,62 | 6 |
| 6210315-3 | 8417157 | 117,15 | 21 |
| 6210400-3 | 8417158 | 134,29 | 18 |
| 6210500-3 | 8417159 | 162,25 | 8 |
| 6210630-3 | 8417160 | 187,49 | 5 |

Vyöhykepeleti KRTM



| Koko Ød | Tuote-koodi | LVI-koodi | Hinta €/kpl |
|----------|-------------|-----------|-------------|
| 100-24V | 110305001 | 8926282 | 453,03 |
| 125-24V | 110305002 | 8926283 | 453,03 |
| 160-24V | 110305003 | 8926284 | 457,18 |
| 100-230V | 110305020 | 8926285 | 456,52 |
| 125-230V | 110305021 | 8926286 | 456,52 |
| 160-230V | 110305022 | 8926287 | 460,61 |

Vakiovirtaussäädin, pyöreä RPM-K



Ilmamäärän säätölaite RPM-V



Ilmavirtasäädin RPM-LV



Hinnat tarjouksen mukaan.

Vakiovirtaussäädin, suorakaide RPMC-K



Ilmamäärän säätölaite RPMC-V



Säätopeleti KR2

Sisältää käsiasäätökahvan

Mitat: leveys x korkeus

Varustettavissa yhdellä tai kahdella pyöreällä liitännällä. Hinnat tarjouksen mukaan.



| Korkeus | Leveys | | | | | | | | | | | | |
|---------|--------|--------|--------|--------|--------|--------|---------|---------|---------|---------|---------|---------|--|
| | 200 | 300 | 400 | 500 | 600 | 800 | 1000 | 1200 | 1400 | 1600 | 1800 | 2000 | |
| 200 | 223,08 | 225,38 | 228,74 | 231,02 | 234,41 | 240,08 | 292,24 | 297,88 | 288,28 | 303,44 | 357,28 | 389,24 | |
| 300 | 229,95 | 233,33 | 236,70 | 240,08 | 273,27 | 288,85 | 304,63 | 317,73 | 350,08 | 350,08 | 392,92 | 482,48 | |
| 400 | 242,59 | 235,49 | 258,10 | 287,65 | 293,31 | 300,06 | 320,33 | 344,39 | 372,12 | 372,12 | 425,80 | 504,43 | |
| 500 | 291,02 | 294,39 | 298,98 | 303,44 | 308,01 | 317,02 | 358,68 | 403,56 | 413,56 | 425,71 | 480,14 | 571,74 | |
| 600 | 303,92 | 296,68 | 311,43 | 306,92 | 327,08 | 353,79 | 391,85 | 432,63 | 447,38 | 447,38 | 537,95 | 582,05 | |
| 700 | 317,94 | 310,31 | 328,60 | 337,71 | 343,65 | 390,77 | 411,12 | 506,79 | 495,79 | 519,42 | 588,90 | 642,04 | |
| 800 | 328,41 | 343,70 | 359,64 | 356,30 | 381,50 | 411,81 | 419,73 | 525,08 | 509,40 | 534,37 | 640,95 | 702,14 | |
| 1000 | 384,63 | 388,48 | 434,73 | 422,18 | 450,91 | 472,10 | 520,19 | 590,22 | 704,72 | 651,88 | 677,21 | 800,54 | |
| 1200 | 454,49 | 483,80 | 494,65 | 526,61 | 543,21 | 578,93 | 613,80 | 718,96 | 754,59 | 789,54 | 823,38 | 958,00 | |
| 1400 | 542,85 | 562,49 | 582,15 | 602,70 | 621,50 | 661,70 | 700,89 | 813,50 | 853,70 | 919,70 | 914,38 | 1051,27 | |
| 1600 | 593,79 | 615,71 | 637,48 | 660,23 | 681,16 | 725,67 | 769,27 | 888,96 | 901,02 | 1003,92 | 1004,08 | 1156,09 | |
| 1800 | 651,52 | 675,46 | 699,51 | 724,58 | 747,33 | 796,44 | 844,44 | 997,78 | 1034,09 | 1031,40 | 1143,50 | 1274,38 | |
| 2000 | 784,78 | 572,03 | 838,85 | 867,01 | 892,89 | 948,03 | 1028,81 | 1164,53 | 1183,82 | 1294,04 | 1274,38 | 1408,89 | |

Ilmanvaihtokanavajärjestelmät

NORDdamper - Säättö- ja sulkupellit

Säättö- ja sulkupelti, tiivistetty KR4

Mitat: leveys x korkeus

Varustettavissa yhdellä tai kahdella pyöreällä liitännällä. Hinnat tarjouksen mukaan.



| Korkeus | Leveys | | | | | | | | | | | |
|---------|---------|---------|---------|---------|---------|---------|---------|---------|---------|---------|---------|---------|
| | 200 | 300 | 400 | 500 | 600 | 800 | 1000 | 1200 | 1400 | 1600 | 1800 | 2000 |
| 200 | 242,03 | 244,20 | 260,43 | 263,80 | 266,22 | 271,75 | 300,15 | 338,84 | 362,54 | 392,35 | 424,48 | 541,37 |
| 300 | 260,43 | 263,80 | 268,37 | 271,75 | 313,67 | 320,52 | 327,29 | 402,67 | 432,63 | 463,30 | 493,87 | 619,67 |
| 400 | 306,31 | 320,89 | 319,14 | 329,35 | 342,52 | 356,21 | 382,03 | 472,54 | 493,58 | 586,72 | 607,66 | 712,92 |
| 500 | 330,63 | 335,29 | 346,58 | 355,63 | 367,10 | 402,67 | 439,72 | 534,14 | 559,55 | 656,29 | 681,44 | 791,29 |
| 600 | 369,97 | 402,25 | 414,83 | 428,33 | 441,26 | 467,88 | 493,86 | 587,10 | 632,42 | 738,89 | 765,06 | 877,57 |
| 700 | 414,83 | 429,97 | 444,74 | 459,98 | 475,04 | 505,51 | 517,38 | 648,75 | 698,32 | 808,45 | 838,85 | 956,03 |
| 800 | 463,56 | 479,62 | 494,68 | 510,72 | 526,33 | 558,56 | 589,57 | 720,44 | 752,57 | 890,79 | 922,53 | 1042,11 |
| 1000 | 544,87 | 563,60 | 581,31 | 600,04 | 618,30 | 655,93 | 711,07 | 841,76 | 879,40 | 1049,73 | 1086,73 | 1235,13 |
| 1200 | 646,21 | 667,77 | 687,97 | 709,34 | 730,18 | 791,93 | 833,70 | 1009,89 | 1052,95 | 1255,40 | 1319,00 | 1453,44 |
| 1400 | 739,26 | 763,57 | 786,06 | 810,57 | 852,77 | 901,52 | 948,32 | 1143,63 | 1192,26 | 1448,24 | 1496,04 | 1637,84 |
| 1600 | 813,87 | 840,95 | 884,81 | 911,90 | 937,95 | 992,10 | 1044,31 | 1258,43 | 1333,87 | 1600,39 | 1653,70 | 1821,38 |
| 1800 | 913,92 | 943,73 | 971,44 | 1001,29 | 1029,91 | 1089,67 | 1147,09 | 1401,06 | 1460,80 | 1759,35 | 1836,62 | 1993,02 |
| 2000 | 1070,85 | 1104,25 | 1135,37 | 1168,77 | 1201,16 | 1267,78 | 1353,79 | 1607,10 | 1674,09 | 2025,12 | 2090,94 | 2184,54 |

Säättö- ja sulkupelti, tiivistetyt ja lämpöeristetyt säleät KR4 S

Mitat: leveys x korkeus

Varustettavissa yhdellä tai kahdella pyöreällä liitännällä. Hinnat tarjouksen mukaan.



| Korkeus | Leveys | | | | | | | | | | | |
|---------|---------|---------|---------|---------|---------|---------|---------|---------|---------|---------|---------|---------|
| | 200 | 300 | 400 | 500 | 600 | 800 | 1000 | 1200 | 1400 | 1600 | 1800 | 2000 |
| 200 | 283,38 | 285,33 | 304,50 | 323,90 | 327,29 | 334,14 | 340,90 | 412,21 | 432,56 | 476,76 | 510,72 | 549,02 |
| 300 | 303,36 | 319,55 | 310,91 | 359,74 | 345,59 | 388,41 | 387,27 | 450,75 | 481,82 | 528,80 | 535,92 | 643,58 |
| 400 | 323,90 | 346,05 | 334,14 | 415,45 | 365,82 | 408,83 | 433,75 | 489,30 | 531,09 | 580,96 | 634,21 | 708,77 |
| 500 | 359,57 | 366,79 | 383,48 | 465,43 | 402,73 | 440,65 | 485,81 | 552,64 | 586,62 | 708,22 | 711,52 | 865,27 |
| 600 | 384,22 | 407,04 | 416,13 | 484,05 | 437,14 | 492,67 | 537,95 | 594,57 | 642,04 | 741,93 | 761,05 | 876,80 |
| 700 | 433,43 | 440,11 | 466,71 | 490,99 | 508,28 | 569,03 | 591,68 | 681,34 | 740,14 | 845,09 | 908,69 | 1047,17 |
| 800 | 463,53 | 495,70 | 492,67 | 536,82 | 531,09 | 587,70 | 645,40 | 738,38 | 767,80 | 913,08 | 935,82 | 1057,08 |
| 1000 | 574,24 | 579,78 | 607,91 | 612,64 | 646,82 | 680,59 | 753,10 | 859,69 | 888,97 | 1057,64 | 1133,55 | 1273,99 |
| 1200 | 681,98 | 701,50 | 694,39 | 739,49 | 737,18 | 806,33 | 879,93 | 1042,66 | 1084,43 | 1273,60 | 1373,93 | 1480,91 |
| 1400 | 781,48 | 784,81 | 806,18 | 869,69 | 857,29 | 933,06 | 1006,77 | 1199,67 | 1227,09 | 1465,43 | 1568,05 | 1650,78 |
| 1600 | 833,57 | 898,46 | 884,39 | 916,19 | 974,97 | 1052,07 | 1136,98 | 1291,36 | 1382,92 | 1659,43 | 1720,34 | 1846,73 |
| 1800 | 943,25 | 968,81 | 994,24 | 1041,82 | 1090,61 | 1178,79 | 1259,26 | 1430,50 | 1493,56 | 1826,62 | 1910,85 | 2036,56 |
| 2000 | 1132,33 | 1128,89 | 1162,85 | 1204,46 | 1225,46 | 1302,25 | 1511,73 | 1651,77 | 1768,91 | 2170,78 | 2125,93 | 2222,42 |

Perhospelti RSKT



| Koko Ød | Tuotekoodi | LVI-koodi | Hinta €/kpl | kpl/laatikko |
|---------|------------|-----------|-------------|--------------|
| 100 | 10806100 | 8417370 | 23,33 | • 12 |
| 125 | 10806125 | 8417371 | 24,39 | • 64 |
| 160 | 10806160 | 8417372 | 28,52 | • 10 |
| 200 | 10806200 | 8417373 | 35,69 | • 10 |
| 250 | 10806250 | 8417374 | 46,51 | • 8 |
| 315 | 10806315 | 8417375 | 52,06 | • 8 |
| 400 | 10806316 | 8417376 | 126,51 | • |

Käsisäätökahva, 15x15 mm (pelleille KROS, KR)



| Tuotekoodi | Hinta €/kpl | |
|------------|-------------|-------|
| 6100000000 | 8417182 | 19,38 |

Käsisäätökahva, 8x8 mm (pelleille KRTS)



| Tuotekoodi | Hinta €/kpl | |
|------------|-------------|-------|
| 100700001 | 8406475 | 18,46 |

NORDdamper - Säätö- ja sulkupellit
**Säätö- ja sulkupelti
KRU**

Mitat: leveys x korkeus

Varustettavissa yhdellä tai kahdella pyöreällä liitännällä. Hinnat tarjouksen mukaan.



| Korkeus | Leveys | | | | | | | | | | | | |
|---------|---------|---------|---------|---------|---------|---------|---------|---------|---------|---------|---------|---------|--|
| | 200 | 300 | 400 | 500 | 600 | 800 | 1000 | 1200 | 1400 | 1600 | 1800 | 2000 | |
| 200 | 368,25 | 380,86 | 392,83 | 405,13 | 417,42 | 442,00 | 466,74 | 554,76 | 579,82 | 646,36 | 700,62 | 855,48 | |
| 300 | 409,38 | 424,48 | 439,72 | 455,44 | 470,84 | 501,82 | 532,64 | 652,43 | 683,57 | 756,51 | 817,30 | 979,38 | |
| 400 | 496,91 | 513,62 | 529,52 | 546,40 | 562,62 | 596,05 | 629,15 | 746,82 | 780,10 | 927,26 | 960,37 | 1126,72 | |
| 500 | 537,72 | 557,38 | 576,70 | 596,37 | 616,22 | 655,71 | 694,87 | 844,17 | 884,33 | 1037,07 | 1076,90 | 1250,46 | |
| 600 | 614,91 | 635,71 | 655,54 | 676,86 | 697,33 | 739,45 | 780,42 | 927,77 | 999,52 | 1167,69 | 1208,98 | 1386,80 | |
| 700 | 655,54 | 679,47 | 702,91 | 727,00 | 750,60 | 798,79 | 846,48 | 1025,28 | 1103,62 | 1277,65 | 1325,51 | 1510,85 | |
| 800 | 732,58 | 757,81 | 781,73 | 807,14 | 831,72 | 882,68 | 931,69 | 1138,51 | 1189,32 | 1407,61 | 1457,76 | 1646,90 | |
| 1000 | 861,05 | 890,71 | 918,74 | 948,24 | 977,25 | 1036,57 | 1123,61 | 1330,25 | 1389,58 | 1658,85 | 1717,35 | 1951,88 | |
| 1200 | 1021,34 | 1055,26 | 1087,22 | 1120,97 | 1153,92 | 1251,59 | 1317,47 | 1595,92 | 1663,93 | 1983,99 | 2084,45 | 2296,85 | |
| 1400 | 1168,17 | 1206,70 | 1242,25 | 1280,94 | 1347,64 | 1424,65 | 1498,57 | 1807,32 | 1884,19 | 2288,67 | 2364,37 | 2588,25 | |
| 1600 | 1286,16 | 1328,95 | 1398,29 | 1441,05 | 1482,35 | 1567,90 | 1650,49 | 1988,75 | 2107,90 | 2529,24 | 2613,49 | 2878,48 | |
| 1800 | 1444,32 | 1491,37 | 1535,27 | 1582,32 | 1627,55 | 1721,95 | 1812,76 | 2214,10 | 2308,67 | 2780,33 | 2902,58 | 3149,71 | |
| 2000 | 1692,29 | 1745,05 | 1794,39 | 1847,00 | 1898,12 | 2003,50 | 2139,36 | 2539,74 | 2645,76 | 3200,35 | 3304,43 | 3452,26 | |

**Säätö- ja sulkupelti
KRU-23**

Mitat: leveys x korkeus

Varustettavissa yhdellä tai kahdella pyöreällä liitännällä. Hinnat tarjouksen mukaan.



| Korkeus | Leveys | | | | | | | | | | | | |
|---------|---------|---------|---------|---------|---------|---------|---------|---------|---------|---------|---------|---------|--|
| | 200 | 300 | 400 | 500 | 600 | 800 | 1000 | 1200 | 1400 | 1600 | 1800 | 2000 | |
| 200 | 474,78 | 511,49 | 547,70 | 584,09 | 620,64 | 693,25 | 766,17 | 902,53 | 975,61 | 1090,50 | 1193,08 | 1395,98 | |
| 300 | 557,22 | 599,17 | 641,12 | 683,89 | 725,86 | 810,58 | 894,81 | 1068,20 | 1153,11 | 1279,61 | 1393,85 | 1609,68 | |
| 400 | 659,97 | 701,76 | 742,90 | 784,52 | 825,98 | 909,57 | 992,65 | 1160,49 | 1243,91 | 1441,21 | 1524,31 | 1740,78 | |
| 500 | 742,07 | 789,61 | 836,47 | 884,01 | 931,53 | 1026,75 | 1121,15 | 1326,00 | 1421,71 | 1630,01 | 1725,24 | 1954,50 | |
| 600 | 834,34 | 881,05 | 927,10 | 974,31 | 1020,85 | 1115,08 | 1207,84 | 1407,29 | 1531,18 | 1751,12 | 1844,53 | 2074,46 | |
| 700 | 916,29 | 968,89 | 1021,01 | 1073,79 | 1126,22 | 1231,77 | 1336,81 | 1573,14 | 1708,66 | 1940,24 | 2045,62 | 2288,16 | |
| 800 | 1008,39 | 1060,83 | 1111,63 | 1163,92 | 1215,54 | 1320,27 | 1423,35 | 1684,25 | 1788,66 | 2061,02 | 2165,10 | 2408,15 | |
| 1000 | 1193,42 | 1251,11 | 1306,99 | 1364,18 | 1421,22 | 1536,42 | 1679,49 | 1941,70 | 2057,11 | 2381,93 | 2496,14 | 2786,71 | |
| 1200 | 1410,24 | 1472,85 | 1533,81 | 1596,42 | 1658,19 | 1813,72 | 1937,29 | 2273,42 | 2398,96 | 2776,88 | 2935,20 | 3205,11 | |
| 1400 | 1613,46 | 1681,79 | 1747,20 | 1815,85 | 1912,39 | 2048,74 | 2182,46 | 2550,71 | 2687,24 | 3151,37 | 3286,56 | 3570,25 | |
| 1600 | 1787,99 | 1861,58 | 1961,71 | 2035,14 | 2107,08 | 2254,25 | 2398,13 | 2798,01 | 2978,78 | 3465,38 | 3607,29 | 3933,92 | |
| 1800 | 2002,51 | 2081,35 | 2156,90 | 2235,74 | 2312,75 | 2470,43 | 2624,62 | 3089,58 | 3247,23 | 3782,48 | 3968,16 | 4278,57 | |
| 2000 | 2307,02 | 2392,41 | 2474,34 | 2559,73 | 2643,31 | 2814,26 | 3015,50 | 3480,76 | 3652,20 | 4272,34 | 4441,47 | 4654,85 | |

**Säätö- ja sulkupelti
KRU-25**

Mitat: leveys x korkeus

Varustettavissa yhdellä tai kahdella pyöreällä liitännällä. Hinnat tarjouksen mukaan.



| Korkeus | Leveys | | | | | | | | | | | | |
|---------|---------|---------|---------|---------|---------|---------|---------|---------|---------|---------|---------|---------|--|
| | 200 | 300 | 400 | 500 | 600 | 800 | 1000 | 1200 | 1400 | 1600 | 1800 | 2000 | |
| 200 | 374,16 | 387,60 | 400,71 | 413,81 | 427,26 | 453,63 | 480,19 | 570,15 | 597,04 | 665,56 | 721,75 | 878,59 | |
| 300 | 433,31 | 452,16 | 471,02 | 490,36 | 509,35 | 547,70 | 585,73 | 712,73 | 751,42 | 831,57 | 899,58 | 1068,86 | |
| 400 | 512,97 | 531,65 | 549,51 | 568,02 | 586,39 | 623,59 | 660,31 | 781,91 | 818,93 | 969,88 | 1006,76 | 1176,87 | |
| 500 | 571,80 | 596,22 | 619,98 | 644,41 | 668,64 | 717,50 | 765,83 | 924,32 | 973,66 | 1135,74 | 1184,56 | 1367,45 | |
| 600 | 640,96 | 664,73 | 687,50 | 711,59 | 734,86 | 782,71 | 829,25 | 982,33 | 1059,85 | 1233,73 | 1280,76 | 1464,31 | |
| 700 | 699,80 | 729,31 | 758,13 | 787,80 | 817,14 | 876,30 | 935,12 | 1125,07 | 1214,40 | 1399,43 | 1458,59 | 1654,91 | |
| 800 | 768,79 | 797,96 | 825,66 | 854,83 | 883,18 | 941,86 | 998,40 | 1212,75 | 1271,25 | 1497,26 | 1554,94 | 1751,61 | |
| 1000 | 907,43 | 941,86 | 974,64 | 1008,88 | 1042,63 | 1111,47 | 1208,01 | 1424,33 | 1493,16 | 1771,77 | 1839,78 | 2083,80 | |
| 1200 | 1077,86 | 1117,53 | 1155,24 | 1194,73 | 1233,24 | 1342,39 | 1419,75 | 1709,49 | 1788,98 | 2120,35 | 2232,29 | 2456,16 | |
| 1400 | 1234,88 | 1280,12 | 1322,23 | 1367,64 | 1441,05 | 1531,18 | 1618,69 | 1940,57 | 2030,71 | 2448,62 | 2537,44 | 2774,75 | |
| 1600 | 1363,03 | 1413,35 | 1490,39 | 1540,70 | 1589,70 | 1690,33 | 1787,99 | 2141,49 | 2275,89 | 2715,59 | 2811,77 | 3092,03 | |
| 1800 | 1531,34 | 1587,06 | 1639,36 | 1695,07 | 1748,82 | 1860,26 | 1968,10 | 2386,67 | 2498,12 | 2986,97 | 3126,29 | 3390,47 | |
| 2000 | 1789,46 | 1851,73 | 1910,41 | 1972,70 | 2033,33 | 2157,72 | 2312,59 | 2731,82 | 2856,86 | 3430,62 | 3553,54 | 3720,38 | |

Ilmanvaihtokanavajärjestelmät

4. NORDsmoke - Savunhallintajärjestelmät

NORDsmoke-savunhallintajärjestelmä sisältää kattavan valikoiman pyöreitä ja suorakaiteen muotoisia savunhallintakanavia ja -osia sekä savunhallintakanavan säätöpellit.

NORDsmoke-savunhallintajärjestelmä on sertifioitu yhden savunpoistolohkon savunhallintajärjestelmä. Järjestelmä on eurooppalaisen harmonisoidun standardin EN 12101-7 vaatimusten mukainen ja luokiteltu standardin EN 13501 mukaisesti.

Savunhallintakanavat on testattu 600°C lämpötilassa 2 tunnin ajan testausstandardin EN 1366-9 mukaisesti. Normaalityöntilan maksimi käyttöpaine 1500 Pa.

Täydellinen valikoima tuotteista löytyy www.etsnord.fi/tuotteet > NORDsmoke

Suorakaide savunhallintajärjestelmän hinnat tarjouksen mukaan.



Kierresaumakanava
Pituus 3 m, tulpattu
NTO-3

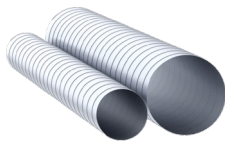

Kierresaumakanava
Pituus 6 m, tulpattu
NTO-6

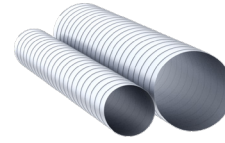

| Koko ØD | Tuotekoodi | LVI-koodi | Hinta €/m | m/ häkki |
|---------|------------|-----------|-----------|----------|
| 100 | 10101013 | 8103322 | 15,54 | 378 |
| 125 | 10101123 | 8103323 | 17,17 | 252 |
| 160 | 10101163 | 8103324 | 21,50 | 153 |
| 200 | 10101203 | 8103325 | 27,73 | 90 |
| 250 | 10101253 | 8103326 | 35,83 | 60 |
| 315 | 10101313 | 8103327 | 43,07 | 36 |
| 400 | 10101403 | 8103328 | 74,45 | 18 |
| 500 | 10101503 | 8103329 | 99,05 | 12 |
| 630 | 10101633 | 8103330 | 125,51 | |
| 800 | 10101803 | 8103331 | 153,44 | |
| 1000 | 10101103 | 8103332 | 258,10 | |

| Tuotekoodi | LVI-koodi | Hinta €/m | m/ häkki |
|------------|-----------|-----------|----------|
| 10101016 | 8103310 | 15,54 | 756 |
| 10101126 | 8103311 | 17,17 | 504 |
| 10101166 | 8103312 | 21,50 | 306 |
| 10101206 | 8103313 | 27,73 | 180 |
| 10101256 | 8103314 | 35,83 | 120 |
| 10101316 | 8103315 | 43,07 | 72 |
| 10101406 | 8103316 | 74,45 | 36 |
| 10101506 | 8103317 | 99,05 | 24 |
| 10101636 | 8103318 | 125,51 | |
| 10101806 | 8103319 | 153,44 | |
| 10101106 | 8103320 | 258,10 | |

Käyrä
NVP-T 90°
NV-T 90°



Käyrä
NVP-T 60°
NV-T 60°



Käyrä
NVP-T 45°
NV-T 45°



| Koko Ød | Tuotekoodi | LVI-koodi | Hinta €/kpl |
|---------|------------|-----------|-------------|
| 100 | 2014264 | 8132558 | 20,21 |
| 125 | 2014318 | 8132563 | 24,24 |
| 160 | 2014363 | 8132568 | 30,16 |
| 200 | 2014424 | 8132573 | 38,12 |
| 250 | 111703005 | 8132028 | 67,39 |
| 315 | 111703006 | 8132029 | 86,63 |
| 400 | 111703007 | 8132030 | 136,57 |
| 500 | 111703008 | 8132031 | 192,43 |
| 630 | 111703009 | 8132032 | 305,94 |
| 800 | 111703010 | 8132033 | 527,42 |
| 1000 | 111703011 | 8132034 | 1056,29 |

| Tuotekoodi | LVI-koodi | Hinta €/kpl |
|------------|-----------|-------------|
| 2014257 | 8132557 | 44,70 |
| 2014301 | 8132562 | 48,80 |
| 2014356 | 8132567 | 77,56 |
| 2014417 | 8132572 | 97,93 |
| 111704005 | 8132040 | 63,14 |
| 111704006 | 8132041 | 70,92 |
| 111704007 | 8132042 | 113,83 |
| 111704008 | 8132043 | 141,47 |
| 111704009 | 8132044 | 206,70 |
| 111704010 | 8132045 | 427,46 |
| 111704011 | 8132046 | 818,66 |

| Tuotekoodi | LVI-koodi | Hinta €/kpl |
|------------|-----------|-------------|
| 2014240 | 8132556 | 19,56 |
| 2014295 | 8132561 | 24,24 |
| 2014349 | 8132566 | 35,66 |
| 2014394 | 8132571 | 39,60 |
| 111705005 | 8132051 | 56,54 |
| 111705006 | 8132052 | 61,40 |
| 111705007 | 8132053 | 99,24 |
| 111705008 | 8132054 | 120,17 |
| 111705009 | 8132055 | 201,08 |
| 111705010 | 8132056 | 368,58 |
| 111705011 | 8132057 | 659,80 |

Käyrä
NVP-T 30°
NV-T 30°



Käyrä
NVP-T 15°
NV-T 15°



| Koko Ød | Tuotekoodi | LVI-koodi | Hinta €/kpl |
|---------|------------|-----------|-------------|
| 100 | 2014233 | 8132555 | 33,53 |
| 125 | 2014288 | 8132560 | 35,99 |
| 160 | 2014332 | 8132565 | 41,82 |
| 200 | 2014387 | 8132570 | 58,99 |
| 250 | 111706005 | 8132063 | 56,14 |
| 315 | 111706006 | 8132064 | 61,00 |
| 400 | 111706007 | 8132065 | 95,84 |
| 500 | 111706008 | 8132066 | 116,58 |
| 630 | 111706009 | 8132067 | 169,44 |
| 800 | 111706010 | 8132068 | 322,16 |
| 1000 | 111706011 | 8132069 | 638,92 |

| Tuotekoodi | LVI-koodi | Hinta €/kpl |
|------------|-----------|-------------|
| 2221228 | 8132574 | 23,64 |
| 2014271 | 8132559 | 36,31 |
| 2014325 | 8132564 | 28,26 |
| 2014370 | 8132569 | 51,43 |
| 111707005 | 8132074 | 58,91 |
| 111707006 | 8132075 | 72,86 |
| 111707007 | 8132076 | 95,47 |
| 111707008 | 8132077 | 107,22 |
| 111707009 | 8132078 | 142,56 |
| 111707010 | 8132079 | 279,42 |
| 111707011 | 8132080 | 552,43 |

Sisäliitin
NI-T



Pitkä sisäliitin
NIL-T



Ulkoliitin
NM



| Koko Ød | Tuotekoodi | LVI-koodi | Hinta €/kpl |
|---------|------------|-----------|-------------|
| 100 | 111708001 | 8132081 | 14,00 |
| 125 | 111708002 | 8132082 | 15,19 |
| 160 | 111708003 | 8132083 | 17,22 |
| 200 | 111708004 | 8132084 | 19,27 |
| 250 | 111708005 | 8132085 | 26,30 |
| 315 | 111708006 | 8132086 | 31,14 |
| 400 | 111708007 | 8132087 | 43,97 |
| 500 | 111708008 | 8132088 | 54,56 |
| 630 | 111708009 | 8132089 | 63,85 |
| 800 | 111708010 | 8132090 | 98,45 |
| 1000 | 111708011 | 8132091 | 141,91 |

| Tuotekoodi | LVI-koodi | Hinta €/kpl |
|------------|-----------|-------------|
| 111709001 | 8132093 | 15,08 |
| 111709002 | 8132094 | 16,44 |
| 111709003 | 8132095 | 18,86 |
| 111709004 | 8132096 | 21,22 |
| 111709005 | 8132097 | 35,32 |
| 111709006 | 8132098 | 41,80 |
| 111709007 | 8132099 | 58,52 |
| 111709008 | 8132100 | 84,90 |
| 111709009 | 8132101 | 107,53 |
| 111709010 | 8132102 | 162,67 |
| 111709011 | 8132103 | 268,75 |

| Tuotekoodi | LVI-koodi | Hinta €/kpl |
|------------|-----------|-------------|
| 10204010 | 8100704 | 4,20 |
| 10204120 | 8100706 | 4,52 |
| 10204160 | 8100708 | 4,85 |
| 10204200 | 8100710 | 5,51 |
| 10204250 | 8100712 | 8,93 |
| 10204310 | 8100714 | 10,88 |
| 10204400 | 8100716 | 15,59 |
| 10204500 | 8100718 | 21,43 |
| 10204630 | 8100720 | 24,98 |
| 10204800 | 8100722 | 49,57 |
| 10204100 | 8100724 | 68,32 |

Lähtökaulus tasopinnalle, jyrkkä
NSK-T



Lähtökaulus tasopinnalle, osalle
NSKM



Tulppa kanavalle
NAL-T



| Koko Ød | Tuotekoodi | LVI-koodi | Hinta €/kpl |
|---------|------------|-----------|-------------|
| 100 | 111713001 | 8132116 | 28,75 |
| 125 | 111713002 | 8132117 | 26,75 |
| 160 | 111713003 | 8132118 | 27,73 |
| 200 | 111713004 | 8132119 | 28,90 |
| 250 | 111713005 | 8132120 | 32,21 |
| 315 | 111713006 | 8132121 | 34,06 |
| 400 | 111713007 | 8132122 | 55,26 |
| 500 | 111713008 | 8132123 | 59,65 |
| 630 | 111713009 | 8132124 | 66,28 |
| 800 | 111713010 | 8132125 | 99,14 |
| 1000 | 111713011 | 8132126 | 127,72 |

| Tuotekoodi | LVI-koodi | Hinta €/kpl |
|------------|-----------|-------------|
| 10206010 | 8100771 | 6,99 |
| 10206120 | 8100772 | 8,02 |
| 10206160 | 8100773 | 9,42 |
| 10206200 | 8100774 | 10,84 |
| 10206250 | 8100775 | 13,50 |
| 10206315 | 8100776 | 17,60 |
| 10206400 | 8100777 | 34,20 |
| 10206500 | 8100778 | 50,36 |
| 10206630 | 8100779 | 75,56 |
| 10206800-1 | 8100780 | 136,51 |
| 10206100 | 8100781 | 173,45 |

| Tuotekoodi | LVI-koodi | Hinta €/kpl |
|------------|-----------|-------------|
| 111715001 | 8132138 | 30,49 |
| 111715002 | 8132139 | 30,95 |
| 111715003 | 8132140 | 31,56 |
| 111715004 | 8132141 | 32,05 |
| 111715005 | 8132142 | 33,58 |
| 111715006 | 8132143 | 48,65 |
| 111715007 | 8132144 | 70,85 |
| 111715008 | 8132145 | 64,10 |
| 111715009 | 8132146 | 74,82 |
| 111715010 | 8132147 | 134,20 |
| 111715011 | 8132148 | 203,03 |

Ilmanvaihtokanavajärjestelmät

NORDsmoke - Pyöreä savunhallintakanavajärjestelmä, galvanoitu

Tulppa kanavalle NALM-T



Tulppa-puhdistusluukku kanavalle NALH-T



Tulppa-puhdistusluukku osalle NALMH-T



| Koko Ød | Tuotekoodi | LVI-koodi | Hinta €/kpl | Tuotekoodi | LVI-koodi | Hinta €/kpl | Tuotekoodi | LVI-koodi | Hinta €/kpl |
|---------|------------|-----------|-------------|------------|-----------|-------------|------------|-----------|-------------|
| 100 | 111716001 | 8132150 | 10,61 | 111717001 | 8132161 | 42,38 | 111718001 | 8132172 | 19,18 |
| 125 | 111716002 | 8132151 | 11,00 | 111717002 | 8132162 | 43,01 | 111718002 | 8132173 | 22,42 |
| 160 | 111716003 | 8132152 | 11,50 | 111717003 | 8132163 | 43,44 | 111718003 | 8132174 | 25,08 |
| 200 | 111716004 | 8132153 | 12,84 | 111717004 | 8132164 | 43,84 | 111718004 | 8132175 | 27,60 |
| 250 | 111716005 | 8132154 | 21,55 | 111717005 | 8132165 | 45,54 | 111718005 | 8132176 | 33,88 |
| 315 | 111716006 | 8132155 | 29,26 | 111717006 | 8132166 | 59,24 | 111718006 | 8132177 | 54,35 |
| 400 | 111716007 | 8132156 | 45,55 | 111717007 | 8132167 | 72,20 | 111718007 | 8132178 | 70,42 |
| 500 | 111716008 | 8132157 | 51,74 | 111717008 | 8132168 | 78,14 | 111718008 | 8132179 | 72,72 |
| 630 | 111716009 | 8132158 | 66,10 | 111717009 | 8132169 | 89,82 | 111718009 | 8132180 | 87,20 |
| 800 | 111716010 | 8132159 | 113,65 | 111717010 | 8132170 | 152,00 | 111718010 | 8132181 | 134,56 |
| 1000 | 111716011 | 8132160 | 175,43 | 111717011 | 8132171 | 220,90 | 111718011 | 8132182 | 196,25 |

Muunto, keskeinen osa/osa NFC-T NFCV-T



Muunto, keskeinen kanava/osa NFCM-T NFCVM-T



Muunto, epäkeskeinen kanava/osa NFBM-T



| Koko Ød1-d2 | Tuotekoodi | LVI-koodi | Hinta €/kpl | Koko ØD-d2 | Tuotekoodi | LVI-koodi | Hinta €/kpl | Koko ØD-d2 | Tuotekoodi | LVI-koodi | Hinta €/kpl |
|-------------|------------|-----------|-------------|------------|------------|-----------|-------------|------------|------------|-----------|-------------|
| 125/100 | 2009413 | 8132498 | 25,55 | 125/100 | 2009581 | 8132509 | 17,99 | 125/100 | 111722001 | 8132285 | 59,39 |
| 160/100 | 2009420 | 8132499 | 27,19 | 160/100 | 2009611 | 8132510 | 19,06 | 160/100 | 111722002 | 8132286 | 61,40 |
| 160/125 | 2009437 | 8132500 | 27,68 | 160/125 | 2009635 | 8132511 | 20,21 | 160/125 | 111722005 | 8132289 | 52,90 |
| 200/100 | 2009444 | 8132501 | 40,34 | 200/100 | 2009659 | 8132512 | 23,17 | 200/100 | 111722003 | 8132287 | 60,25 |
| 200/125 | 2009468 | 8132502 | 35,58 | 200/125 | 2009673 | 8132513 | 24,32 | 200/125 | 111722006 | 8132290 | 56,15 |
| 200/160 | 2009482 | 8132503 | 35,09 | 200/160 | 2009697 | 8132514 | 26,12 | 200/160 | 111722009 | 8132293 | 50,66 |
| 250/160 | 2009505 | 8132504 | 45,77 | 250/160 | 2009727 | 8132516 | 32,04 | 250/100 | 111722004 | 8132288 | 59,17 |
| 250/200 | 2009512 | 8132505 | 46,75 | 250/200 | 2009741 | 8132517 | 33,44 | 250/125 | 111722007 | 8132291 | 68,11 |
| 315/160 | 2009536 | 8132506 | 56,86 | 315/160 | 2009765 | 8132518 | 40,75 | 250/160 | 111722010 | 8132294 | 66,67 |
| 315/200 | 2009550 | 8132507 | 58,25 | 315/200 | 2009789 | 8132519 | 42,14 | 250/200 | 111722013 | 8132297 | 66,10 |
| 315/250 | 2009574 | 8132508 | 60,38 | 315/250 | 2009802 | 8132520 | 43,55 | 315/125 | 111722008 | 8132292 | 78,56 |
| 250/100 | 111719004 | 8132186 | 42,45 | 250/100 | 111720004 | 8132220 | 66,31 | 315/160 | 111722011 | 8132295 | 79,07 |
| 250/125 | 111719007 | 8132189 | 78,13 | 250/125 | 111720007 | 8132223 | 69,12 | 315/200 | 111722014 | 8132298 | 82,74 |
| 315/125 | 111719008 | 8132190 | 88,64 | 315/125 | 111720008 | 8132224 | 79,21 | 315/250 | 111722017 | 8132301 | 88,64 |
| 400/125 | MP00409 | 8132496 | 100,72 | 315/200 | 111720014 | 8132230 | 54,13 | 400/160 | 111722012 | 8132296 | 102,28 |
| 400/160 | 111719012 | 8132194 | 100,72 | 400/160 | 111720012 | 8132228 | 104,08 | 400/200 | 111722015 | 8132299 | 99,60 |
| 400/200 | 111719015 | 8132197 | 102,50 | 400/200 | 111720015 | 8132231 | 102,56 | 400/250 | 111722018 | 8132302 | 99,96 |
| 400/250 | 111719018 | 8132200 | 103,79 | 400/250 | 111720018 | 8132234 | 103,43 | 400/315 | 111722021 | 8132305 | 93,55 |
| 400/315 | 111719021 | 8132203 | 105,07 | 400/315 | 111720021 | 8132237 | 97,08 | 500/200 | 111722016 | 8132300 | 126,35 |
| 500/200 | 111719016 | 8132198 | 141,19 | 500/200 | 111720016 | 8132232 | 129,08 | 500/250 | 111722019 | 8132303 | 138,31 |
| 500/250 | 111719019 | 8132201 | 142,13 | 500/250 | 111720019 | 8132235 | 129,95 | 500/315 | 111722022 | 8132306 | 130,45 |
| 500/315 | 111719022 | 8132204 | 118,72 | 500/315 | 111720022 | 8132238 | 123,02 | 500/400 | 111722025 | 8132309 | 121,58 |
| 500/400 | 111719025 | 8132207 | 135,56 | 500/400 | 111720025 | 8132241 | 113,87 | 630/250 | 111722020 | 8132304 | 162,46 |
| 630/250 | 111719020 | 8132202 | 174,28 | 630/250 | 111720020 | 8132236 | 159,71 | 630/315 | 111722023 | 8132307 | 162,10 |
| 630/315 | 111719023 | 8132205 | 178,60 | 630/315 | 111720023 | 8132239 | 164,11 | 630/400 | 111722026 | 8132310 | 158,99 |
| 630/400 | 111719026 | 8132208 | 155,95 | 630/400 | 111720026 | 8132242 | 164,90 | 630/500 | 111722029 | 8132313 | 147,17 |
| 630/500 | 111719029 | 8132211 | 162,53 | 630/500 | 111720029 | 8132245 | 154,16 | 800/315 | 111722024 | 8132308 | 238,49 |
| 800/315 | 111719024 | 8132206 | 180,59 | 800/315 | 111720024 | 8132240 | 112,86 | 800/400 | 111722027 | 8132311 | 238,49 |
| 800/400 | 111719027 | 8132209 | 264,72 | 800/400 | 111720027 | 8132243 | 243,96 | 800/500 | 111722030 | 8132314 | 233,94 |
| 800/500 | 111719030 | 8132212 | 266,52 | 800/500 | 111720030 | 8132246 | 245,76 | 800/630 | 111722032 | 8132316 | 206,92 |
| 800/630 | 111719032 | 8132214 | 227,86 | 800/630 | 111720032 | 8132248 | 217,94 | 1000/400 | 111722028 | 8132312 | 182,56 |
| 1000/400 | 111719028 | 8132210 | 371,53 | 1000/400 | 111720028 | 8132244 | 343,50 | 1000/500 | 111722031 | 8132315 | 351,42 |
| 1000/500 | 111719031 | 8132213 | 380,47 | 1000/500 | 111720031 | 8132247 | 352,64 | 1000/630 | 111722033 | 8132317 | 347,17 |
| 1000/630 | 111719033 | 8132215 | 393,23 | 1000/630 | 111720033 | 8132249 | 365,40 | 1000/800 | 111722034 | 8132318 | 311,71 |
| 1000/800 | 111719034 | 8132216 | 359,86 | 1000/800 | 111720034 | 8132250 | 332,11 | | | | |

NORDsmoke - Pyöreä savunhallintakanavajärjestelmä, galvanoitu
**Muunto, epäkeskeinen
osa/osa
NFB-T**

| Koko Ød1-d2 | Tuotekoodi | LVI-koodi | Hinta €/kpl |
|----------------|------------|-----------|----------------|
| 125/100 | 111721001 | 8132251 | 64,79 |
| 160/100 | 111721002 | 8132252 | 67,39 |
| 160/125 | 111721005 | 8132255 | 59,24 |
| 200/100 | 111721003 | 8132253 | 58,67 |
| 200/125 | 111721006 | 8132256 | 61,60 |
| 200/160 | 111721009 | 8132259 | 65,78 |
| 250/100 | 111721004 | 8132254 | 74,88 |
| 250/125 | 111721007 | 8132257 | 68,75 |
| 250/160 | 111721010 | 8132260 | 69,31 |
| 250/200 | 111721013 | 8132263 | 70,90 |
| 315/125 | 111721008 | 8132258 | 88,00 |
| 315/160 | 111721011 | 8132261 | 86,48 |

| Koko Ød1-d2 | Tuotekoodi | LVI-koodi | Hinta €/kpl |
|----------------|------------|-----------|----------------|
| 315/200 | 111721014 | 8132264 | 87,64 |
| 315/250 | 111721017 | 8132267 | 89,72 |
| 400/125 | MP00408 | 8132497 | 103,79 |
| 400/160 | 111721012 | 8132262 | 103,79 |
| 400/200 | 111721015 | 8132265 | 103,97 |
| 400/250 | 111721018 | 8132268 | 104,82 |
| 400/315 | 111721021 | 8132271 | 110,06 |
| 500/200 | 111721016 | 8132266 | 138,53 |
| 500/250 | 111721019 | 8132269 | 150,28 |
| 500/315 | 111721022 | 8132272 | 142,63 |
| 500/400 | 111721025 | 8132275 | 138,31 |
| 630/250 | 111721020 | 8132270 | 177,01 |

| Koko Ød1-d2 | Tuotekoodi | LVI-koodi | Hinta €/kpl |
|----------------|------------|-----------|----------------|
| 630/315 | 111721023 | 8132273 | 176,51 |
| 630/400 | 111721026 | 8132276 | 157,12 |
| 630/500 | 111721029 | 8132279 | 159,67 |
| 800/315 | 111721024 | 8132274 | 259,32 |
| 800/400 | 111721027 | 8132277 | 259,32 |
| 800/500 | 111721030 | 8132280 | 254,56 |
| 800/630 | 111721032 | 8132282 | 227,68 |
| 1000/400 | 111721028 | 8132278 | 384,79 |
| 1000/500 | 111721031 | 8132281 | 379,46 |
| 1000/630 | 111721033 | 8132283 | 375,13 |
| 1000/800 | 111721034 | 8132284 | 339,38 |

**Lähtökaulus, lyhyt kaulus
NPS-T
NPSK-T**

| Koko ØD-d | Tuotekoodi | LVI-koodi | Hinta €/kpl |
|--------------|------------|-----------|----------------|
| 100/100 | 2010686 | 8132521 | 15,29 |
| 125/100 | 2013830 | 8132522 | 15,29 |
| 125/125 | 2013847 | 8132523 | 14,46 |
| 160/100 | 2013854 | 8132524 | 15,29 |
| 160/125 | 2013861 | 8132525 | 14,46 |
| 160/160 | 2013878 | 8132526 | 20,78 |
| 200/100 | 2013885 | 8132527 | 16,02 |
| 200/125 | 2013892 | 8132528 | 14,46 |
| 200/160 | 2013908 | 8132529 | 20,38 |
| 200/200 | 2013922 | 8132530 | 26,95 |
| 250/100 | 2013977 | 8132531 | 16,02 |
| 250/125 | 2014004 | 8132532 | 14,46 |
| 250/160 | 2014011 | 8132533 | 20,21 |
| 250/200 | 2014028 | 8132534 | 26,78 |
| 250/250 | 2014035 | 8132535 | 38,87 |
| 315/100 | 2014042 | 8132536 | 16,02 |
| 315/125 | 2014059 | 8132537 | 14,63 |
| 315/160 | 2014066 | 8132538 | 20,54 |
| 315/200 | 2014073 | 8132539 | 26,78 |
| 315/250 | 2014080 | 8132540 | 38,87 |
| 315/315 | 2014097 | 8132541 | 52,75 |
| 400/160 | 2014103 | 8132542 | 20,21 |
| 400/200 | 2014110 | 8132543 | 26,21 |
| 400/250 | 2014127 | 8132544 | 38,62 |
| 400/315 | 2014134 | 8132545 | 50,28 |
| 500/100 | 2014141 | 8132546 | 16,02 |
| 500/125 | 2014158 | 8132547 | 18,16 |
| 500/160 | 2014165 | 8132548 | 25,63 |
| 500/200 | 2014172 | 8132549 | 28,10 |
| 500/250 | 2014189 | 8132550 | 41,08 |
| 500/315 | 2014196 | 8132551 | 55,13 |
| 630/200 | 2014202 | 8132552 | 33,60 |
| 630/250 | 2014219 | 8132553 | 41,08 |
| 630/315 | 2014226 | 8132554 | 55,13 |

**T-yhde
NTK-T**

| Koko Ød1-d2 | Tuotekoodi | LVI-koodi | Hinta €/kpl |
|----------------|------------|-----------|----------------|
| 100/100 | 111725001 | 8132375 | 77,83 |
| 125/100 | 111725002 | 8132376 | 84,26 |
| 125/125 | 111725003 | 8132377 | 85,57 |
| 160/100 | 111725004 | 8132378 | 88,84 |
| 160/125 | 111725005 | 8132379 | 90,97 |
| 160/160 | 111725006 | 8132380 | 92,44 |
| 200/100 | 111725007 | 8132381 | 99,55 |
| 200/125 | 111725008 | 8132382 | 96,82 |
| 200/160 | 111725009 | 8132383 | 98,46 |
| 200/200 | 111725010 | 8132384 | 102,17 |
| 250/125 | 111725011 | 8132385 | 108,19 |
| 250/160 | 111725012 | 8132386 | 109,96 |
| 250/200 | 111725013 | 8132387 | 112,68 |
| 250/250 | 111725014 | 8132388 | 118,90 |
| 315/160 | 111725015 | 8132389 | 118,51 |
| 315/200 | 111725016 | 8132390 | 122,78 |
| 315/250 | 111725017 | 8132391 | 129,02 |
| 315/315 | 111725018 | 8132392 | 165,12 |
| 400/200 | 111725019 | 8132393 | 156,06 |
| 400/250 | 111725020 | 8132394 | 162,77 |
| 400/315 | 111725021 | 8132395 | 169,60 |
| 500/250 | 111725023 | 8132397 | 233,15 |
| 500/315 | 111725024 | 8132398 | 242,23 |
| 500/250 | 111725023 | 8132397 | 233,15 |
| 500/315 | 111725024 | 8132398 | 242,23 |
| 630/315 | 111725027 | 8132401 | 321,16 |

Ilmanvaihtokanavajärjestelmät

NORDsmoke - Pyöreä savunhallintakanavajärjestelmä, galvanoitu

Lähtökaulus
NPSV-T

| Koko ØD-d | Tuotekoodi | LVI-koodi | Hinta €/kpl |
|-----------|------------|-----------|-------------|
| 400/400 | 111724001 | 8132361 | 121,73 |
| 500/400 | 111724002 | 8132362 | 127,72 |
| 500/500 | 111724005 | 8132365 | 151,50 |
| 630/400 | 111724003 | 8132363 | 145,66 |
| 630/500 | 111724006 | 8132366 | 172,75 |
| 630/630 | 111724009 | 8132369 | 210,24 |
| 800/400 | 111724004 | 8132364 | 155,10 |
| 800/500 | 111724007 | 8132367 | 180,83 |
| 800/630 | 111724010 | 8132370 | 229,62 |
| 800/800 | 111724012 | 8132372 | 295,07 |
| 1000/500 | 111724008 | 8132368 | 185,36 |
| 1000/630 | 111724011 | 8132371 | 227,68 |
| 1000/800 | 111724013 | 8132373 | 302,63 |
| 1000/1000 | 111724014 | 8132374 | 489,01 |

T-yhde
NTKV-T

| Koko Ød1-d2 | Tuotekoodi | LVI-koodi | Hinta €/kpl |
|-------------|------------|-----------|-------------|
| 400/400 | 111726001 | 8132413 | 249,37 |
| 500/400 | 111726002 | 8132414 | 352,00 |
| 500/500 | 111726003 | 8132415 | 381,26 |
| 630/400 | 111726004 | 8132416 | 490,09 |
| 630/500 | 111726005 | 8132417 | 529,80 |
| 630/630 | 111726006 | 8132418 | 587,10 |
| 800/400 | 111726007 | 8132419 | 676,68 |
| 800/500 | 111726008 | 8132420 | 776,00 |
| 800/630 | 111726009 | 8132421 | 858,74 |
| 800/800 | 111726010 | 8132422 | 977,22 |
| 1000/500 | 111726011 | 8132423 | 998,20 |
| 1000/630 | 111726012 | 8132424 | 1183,36 |
| 1000/800 | 111726013 | 8132425 | 1316,54 |
| 1000/1000 | 111726014 | 8132426 | 1866,89 |

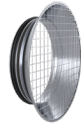
Imukartio suojaverkolla
NK-T

| Koko Ød | Tuotekoodi | LVI-koodi | Hinta €/kpl |
|---------|------------|-----------|-------------|
| 100 | 111745001 | 8132472 | 30,26 |
| 125 | 111745002 | 8132473 | 34,36 |
| 160 | 111745003 | 8132474 | 38,42 |
| 200 | 111745004 | 8132475 | 46,40 |
| 250 | 111745005 | 8132476 | 53,52 |
| 315 | 111745006 | 8132477 | 62,47 |
| 400 | 111745007 | 8132478 | 76,19 |
| 500 | 111745008 | 8132479 | 93,22 |
| 630 | 111745009 | 8132480 | 114,34 |
| 800 | 111745010 | 8132481 | 159,19 |
| 1000 | 111745011 | 8132482 | 220,56 |

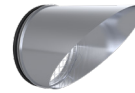
Viisto imupää verkolla
NP-T

| Tuotekoodi | LVI-koodi | Hinta €/kpl |
|------------|-----------|-------------|
| 111746001 | 8132483 | 41,65 |
| 111746002 | 8132484 | 54,38 |
| 111746003 | 8132485 | 57,42 |
| 111746004 | 8132486 | 60,82 |
| 111746005 | 8132487 | 81,73 |
| 111746006 | 8132488 | 89,33 |
| 111746007 | 8132489 | 111,41 |
| 111746008 | 8132490 | 139,63 |
| 111746009 | 8132491 | 186,23 |
| 111746010 | 8132492 | 259,49 |
| 111746011 | 8132493 | 400,00 |

Imupää suojaverkolla
NG-T

| Tuotekoodi | LVI-koodi | Hinta €/kpl |
|------------|-----------|-------------|
| 111744001 | 8132461 | 22,56 |
| 111744002 | 8132462 | 26,46 |
| 111744003 | 8132463 | 28,52 |
| 111744004 | 8132464 | 30,84 |
| 111744005 | 8132465 | 38,33 |
| 111744006 | 8132466 | 43,31 |
| 111744007 | 8132467 | 52,74 |
| 111744008 | 8132468 | 64,88 |
| 111744009 | 8132469 | 84,46 |
| 111744010 | 8132470 | 116,95 |
| 111744011 | 8132471 | 164,53 |

NORDsmoke - Pyöreä savunhallintakanavajärjestelmä, galvanoitu
**Säätöpelti
KRI-T**

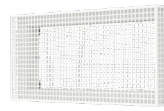
**Poistoilmasäleikkö
(kiinnityскеhyksellä)
RSN-T**

**Savunhallintakanavan säätöpelti
KR2-T**

| Koko Ød | Tuote-koodi | LVI-koodi | Hinta €/kpl | Koko BxH | Tuote-koodi | LVI-koodi | Hinta €/kpl |
|---------|-------------|-----------|-------------|----------|-------------|-----------|-------------|
| 100 | 111748001 | 8417377 | 88,19 | 200x100 | 120111001 | 8741211 | 150,89 |
| 125 | 111748002 | 8417378 | 95,61 | 200x150 | 120111002 | 8741212 | 156,66 |
| 160 | 111748003 | 8417379 | 122,39 | 300x100 | 120111003 | 8741213 | 158,80 |
| 200 | 111748004 | 8417380 | 131,23 | 300x150 | 120111004 | 8741214 | 166,08 |
| 250 | 111748005 | 8417381 | 188,62 | 300x200 | 120111005 | 8741215 | 173,07 |
| 315 | 111748006 | 8417382 | 222,11 | 400x100 | 120111006 | 8741216 | 167,39 |
| 400 | 111748007 | 8417383 | 455,54 | 400x150 | 120111007 | 8741217 | 175,95 |
| 500 | 111748008 | 8417384 | 659,65 | 400x200 | 120111008 | 8741218 | 183,40 |
| 630 | 111748009 | 8417385 | 953,87 | 500x150 | 120111009 | 8741219 | 185,08 |
| 800 | 111748010 | 8417386 | 1862,16 | 500x200 | 120111010 | 8741220 | 194,56 |
| | | | | 600x150 | 120111011 | 8741221 | 195,33 |
| | | | | 600x200 | 120111012 | 8741222 | 205,66 |
| | | | | 800x150 | 120111013 | 8741223 | 217,42 |
| | | | | 800x200 | 120111014 | 8741224 | 227,75 |
| | | | | 1000x20 | 120111015 | 8741225 | 253,03 |

Hinnat tarjouksen mukaan.

**Savunhallintakanavan sulkupelti
KRS-T**



Hinnat tarjouksen mukaan.

**Savunhallintapelti
SEDS-L**

Yhden osaston savunhallintapelti.
Varustettu sähköisellä toimilaitteella.
Paloluokka E₆₀₀ 120
Testattu standardin EN 1366-10 mukaan.
Hinnat tarjouksen mukaan.

**Savunhallintapelti
SEDS-R**

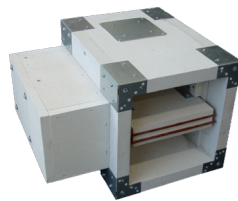
Yhden osaston savunhallintapelti.
Varustettu sähköisellä toimilaitteella.
Paloluokka E₆₀₀ 120
Testattu standardin EN 1366-10 mukaan.
Hinnat tarjouksen mukaan.

**Savunhallintapelti
SEDM**

Usean osaston savunhallintapelti.
Paloluokka EIS120.
Hinnat tarjouksen mukaan.

**Savunhallintapelti
SEDM-L**

Usean osaston savunhallintapelti.
Paloluokka EIS120.
Hinnat tarjouksen mukaan.



Ilmanvaihtokanavajärjestelmät

5. NORDfire – Palotuotteet

MANDIK®

Kauluspalopelti mikrokytkimin
FDMS
.80

Paloluokka EIS90 / EIS60

| Koko Ød | Tuotekoodi | LVI-koodi | Hinta €/kpl |
|---------|------------|-----------|-------------|
| 100 | 110422021 | 8432165 | 254,07 |
| 125 | 110422022 | 8432166 | 257,05 |
| 160 | 110422023 | 8432167 | 275,58 |
| 200 | 110422024 | 8432168 | 301,81 |
| 250 | 110422025 | 8432169 | 349,85 |
| 315 | 110422026 | 8432170 | 395,45 |
| 400 | 110422027 | 8432171 | 500,21 |
| 500 | 110422028 | 8432172 | 599,49 |
| 630 | 110422029 | 8432173 | 704,65 |

Kauluspalopelti 24V toimilaitteella
FDMS
.50

Paloluokka EIS90/EIS120

| Koko Ød | Tuotekoodi | LVI-koodi | Hinta €/kpl |
|---------|------------|-----------|-------------|
| 100 | 110422041 | 8432183 | 746,60 |
| 125 | 110422042 | 8432184 | 751,69 |
| 160 | 110422043 | 8432185 | 756,49 |
| 200 | 110422044 | 8432186 | 782,12 |
| 250 | 110422045 | 8432187 | 806,94 |
| 315 | 110422046 | 8432188 | 830,33 |
| 400 | 110422047 | 8432189 | 866,58 |
| 500 | 110422048 | 8432190 | 987,15 |
| 630 | 110422049 | 8432191 | 1138,07 |

Palopelti mikrokytkimin
FDMR .80 100-800Paloluokka EIS90/EIS120
72 °C sulakelaukaisu

| Koko Ød | Tuotekoodi | LVI-koodi | Hinta €/kpl |
|---------|------------|-----------|-------------|
| 100 | 110423120 | 8433024 | 367,28 |
| 125 | 110423121 | 8433025 | 375,45 |
| 160 | 110423122 | 8433026 | 390,65 |
| 200 | 110423123 | 8433027 | 381,58 |
| 250 | 110423124 | 8433028 | 416,02 |
| 315 | 110423125 | 8433029 | 459,06 |
| 400 | 110423126 | 8433030 | 558,91 |
| 500 | 110423127 | 8433031 | 654,95 |
| 630 | 110423128 | 8433032 | 782,46 |
| 800 | 110423129 | 8433033 | 1274,57 |

Palopelti toimilaitteella
FDMR .50 100-800Paloluokka EIS90/EIS120
72 °C sulakelaukaisu

| Koko Ød | Tuotekoodi | LVI-koodi | Hinta €/kpl |
|---------|------------|-----------|-------------|
| 100 | 110423140 | 8433044 | 818,40 |
| 125 | 110423141 | 8433045 | 819,97 |
| 160 | 110423142 | 8433046 | 843,71 |
| 200 | 110423143 | 8433047 | 911,38 |
| 250 | 110423144 | 8433048 | 948,44 |
| 315 | 110423145 | 8433049 | 994,98 |
| 400 | 110423146 | 8433050 | 1073,79 |
| 500 | 110423147 | 8433051 | 1177,40 |
| 630 | 110423148 | 8433052 | 1455,62 |
| 800 | 110423149 | 8433053 | 1837,58 |

Palopelti
FDMAPaloluokka EI120 ATEX
Hinnat tarjouksen mukaan.Palopelti
FDMBPaloluokka EI120
Hinnat tarjouksen mukaan.Palonrajoitin
DM-SPaloluokka ES30
Hinnat tarjouksen mukaan.

6. ETScontrol -palopeltien ohjaus- ja valvontajärjestelmä

ETS Control on BACnet- ja Modbus-väyläpohjainen palopeltien ohjaus- ja valvontajärjestelmä. Järjestelmän käyttö tapahtuu joko suoraan graafiselta käyttöpaneelilta tai internetin kautta. Järjestelmä koostuu kommunikointimoduuleista (BIO) sekä keskusyksiköstä (BRP). Yhteen keskusyksikköön voidaan liittää jopa 99 kpl BIO-kommunikointimoduuleja. Järjestelmän käyttö tapahtuu joko graafisen käyttöpaneelin, wifi-verkon tai internetin kautta millä tahansa selainpohjaisella laitteella (tietokone, tabletti, älypuhelin). Järjestelmän laajennus toteutetaan lisäämällä uusi prosessori master-slave-periaatteella, jolloin järjestelmää voidaan laajentaa käytännössä rajattomasti. Järjestelmän kommunikointiprotokollat ovat joko BACnet tai Modbus, joten se on erittäin helppo integroida osaksi kiinteistön automaatiojärjestelmää.

Hinnat tarjouksen mukaan.

Lisätietoja ETS Controllista löydät www.etsnord.fi/tuotteet > NORDfire

7. NORDsilencer - Äänenvaimentimet

Pyöreä äänenvaimennin,
lasikuituhuovalla suojattu mineraalivilla 50 mm
NRF 50



| Koko-pituus Ød - L | Tuotekoodi | LVI-koodi | Hinta €-kpl |
|-----------------------|------------|-----------|-------------|
| 100-300 | 10211023 | 8324362 | 55,54 • |
| 100-600 | 10211026 | 8324363 | 75,52 • |
| 100-900 | 10211029 | 8324364 | 95,50 • |
| 100-1200 | 10211022 | 8324365 | 164,57 |
| 125-300 | 10211123 | 8324366 | 71,53 • |
| 125-600 | 10211126 | 8324367 | 84,17 • |
| 125-900 | 10211129 | 8324368 | 105,44 • |
| 125-1200 | 10211122 | 8324369 | 150,95 |
| 160-300 | 10211163 | 8324370 | 87,95 |
| 160-600 | 10211166 | 8324371 | 97,60 • |
| 160-900 | 10211169 | 8324372 | 122,90 • |
| 160-1200 | 10211162 | 8324373 | 151,95 |
| 200-300 | 10211203 | 8324374 | 100,21 |
| 200-600 | 10211206 | 8324375 | 112,64 • |
| 200-900 | 10211209 | 8324376 | 145,43 • |
| 200-1200 | 10211202 | 8324377 | 179,42 |
| 250-300 | 10211253 | 8324378 | 119,75 |
| 250-600 | 10211256 | 8324379 | 138,68 • |
| 250-900 | 10211259 | 8324380 | 181,13 • |
| 250-1200 | 10212252 | 8324381 | 279,24 |
| 315-600 | 10211316 | 8324383 | 170,24 • |
| 315-900 | 10212319 | 8324384 | 221,38 • |
| 315-1200 | 10212312 | 8324385 | 315,68 |
| 400-600 | 10211406 | 8324386 | 339,53 |
| 400-900 | 10211408 | 8324387 | 399,96 |
| 400-1200 | 10212412 | 8324388 | 448,40 |
| 500-600 | 102115060 | 8324389 | 356,50 |
| 500-900 | 1021159 | 8324390 | 427,94 |
| 500-1200 | 10211512 | 8324391 | 539,10 |

Pyöreä äänenvaimennin,
polyesterieriste 50 mm
NRP 50



| Koko-pituus Ød - L | Tuotekoodi | LVI-koodi | Hinta €-kpl |
|-----------------------|-------------|-----------|-------------|
| 100/300 | 10211023-1 | 8324239 | 90,03 • |
| 100/600 | 10211026-1 | 8324240 | 92,35 • |
| 100/900 | 10211029-1 | 8324241 | 111,90 • |
| 100/1200 | 10211022-1 | 8324242 | 175,16 |
| 125/300 | 10211123-1 | 8324243 | 95,99 • |
| 125/600 | 10211126-1 | 8324244 | 100,00 • |
| 125/900 | 10211129-1 | 8324245 | 120,38 • |
| 125/1200 | 10211122-1 | 8324246 | 193,65 |
| 160/300 | 10211163-1 | 8324247 | 110,85 • |
| 160/600 | 10211166-1 | 8324248 | 114,96 • |
| 160/900 | 10211169-1 | 8324249 | 137,52 • |
| 160/1200 | 10211162-1 | 8324250 | 217,81 |
| 200/300 | 10211203-1 | 8324251 | 125,67 |
| 200/600 | 10211206-1 | 8324252 | 127,73 • |
| 200/900 | 10211209-1 | 8324253 | 163,79 • |
| 200/1200 | 10211202-1 | 8324254 | 247,22 |
| 250/600 | 10211256-1 | 8324256 | 155,60 • |
| 250/900 | 10211259-1 | 8324257 | 201,78 • |
| 250/1200 | 10212252-1 | 8324258 | 291,66 • |
| 315/600 | 10211316-1 | 8324260 | 185,91 • |
| 315/900 | 10212319-1 | 8324261 | 236,80 • |
| 315/1200 | 10212312-1 | 8324262 | 341,02 |
| 400/600 | 10211406-1 | 8324264 | 349,84 • |
| 400/900 | 10211408-1 | 8324265 | 411,93 • |
| 400/1200 | 10212412-1 | 8324266 | 461,75 |
| 500/600 | 102115060-1 | 8324267 | 366,08 • |
| 500/900 | 10211590-1 | 8324268 | 469,86 • |
| 500/1200 | 10211512-1 | 8324269 | 579,30 |
| 630/900 | 10211639-1 | 8324270 | 549,24 |
| 630/1200 | 10211612-1 | 8324271 | 698,03 |
| 800/900 | 10211809-1 | 8324272 | 754,09 |
| 800/1200 | 10211812-1 | 8324273 | 1017,72 |

Pyöreä äänenvaimennin,
lasikuituhuovalla suojattu
mineraalivilla 100 mm
NRF 100



| Koko-pituus Ød - L | Tuotekoodi | LVI-koodi | Hinta €-kpl |
|-----------------------|------------|-----------|-------------|
| 100/900 | 10211100 | 8324400 | 176,69 |
| 125/900 | 10211127 | 8324404 | 192,99 |
| 125/1200 | 102111212 | 8324405 | 222,31 |
| 160/900 | 10211160 | 8324408 | 214,78 |
| 160/1200 | 102111612 | 8324409 | 250,10 |
| 200/600 | 102112060 | 8324411 | 199,57 |
| 200/900 | 102112090 | 8324412 | 241,72 |
| 200/1200 | 102112012 | 8324413 | 283,91 |
| 250/600 | 102112506 | 8324416 | 239,31 |
| 250/900 | 10211250 | 8324417 | 284,58 |
| 250/1200 | 10211252 | 8324418 | 339,70 |
| 315/600 | 102113160 | 8324421 | 262,78 |
| 315/900 | 10211319 | 8324422 | 292,17 |
| 315/1200 | 10211312 | 8324423 | 364,46 |

| Koko-pituus Ød - L | Tuotekoodi | LVI-koodi | Hinta €-kpl |
|-----------------------|------------|-----------|-------------|
| 400/600 | 10211405 | 8324427 | 371,88 |
| 400/900 | 10211409 | 8324428 | 443,99 |
| 400/1200 | 10211412 | 8324429 | 536,92 |
| 500/600 | 10211506 | 8324433 | 402,08 |
| 500/900 | 10211509 | 8324434 | 504,43 |
| 500/1200 | 10211515 | 8324435 | 664,01 |
| 500/1500 | 10211512B | 8324436 | 911,91 |
| 630/600 | 102116305 | 8324816 | 422,20 |
| 630/900 | 102116309 | 8324438 | 720,05 |
| 630/1200 | 10211632 | 8324439 | 776,07 |
| 800/900 | 10211805 | 8324443 | 1122,90 |
| 800/1200 | 10211802 | 8324444 | 1209,44 |
| 1000/900 | 102111006 | 8324815 | 1557,27 |
| 1000/1200 | 102111002 | 8324447 | 1770,56 |

Ilmanvaihtokanavajärjestelmät

NORDsilencer – Äänenvaimentimet

Pyöreä äänenvaimennin,
polyesterieriste 100 mm
NRP 100



| Koko-pituus Ød - L | Tuotekoodi | LVI-koodi | Hinta €-kpl |
|-----------------------|-------------|-----------|-------------|
| 100/600 | 110502400 | 8324286 | 162,21 |
| 100/900 | 10211100-1 | 8324287 | 185,34 |
| 125/600 | 10211125-1 | 8324288 | 184,16 |
| 125/900 | 10211127-1 | 8324289 | 203,71 |
| 160/600 | 110502404 | 8324290 | 191,45 |
| 160/900 | 10211160-1 | 8324291 | 228,71 |
| 160/1200 | 102111612-1 | 8324292 | 297,41 |
| 200/600 | 102112060-1 | 8324293 | 211,00 |
| 200/900 | 102112090-1 | 8324294 | 259,06 |
| 200/1200 | 102112012-1 | 8324295 | 306,97 |
| 250/600 | 102112506-1 | 8324296 | 243,58 |
| 250/900 | 10211250-1 | 8324297 | 306,06 |
| 250/1200 | 10211252-1 | 8324298 | 368,55 |
| 315/600 | 102113160-1 | 8324299 | 280,91 |
| 315/900 | 10211319-1 | 8324300 | 356,18 |
| 315/1200 | 10211312-1 | 8324301 | 431,33 |
| 400/600 | 10211405-1 | 8324302 | 382,93 |
| 400/900 | 10211409-1 | 8324274 | 457,36 |
| 400/1200 | 10211412-1 | 8324303 | 553,01 |
| 500/600 | 10211506-1 | 8324304 | 487,15 |
| 500/900 | 10211509-1 | 8324275 | 562,78 |
| 500/1200 | 10211515-1 | 8324305 | 683,91 |
| 630/900 | 102116309-1 | 8324306 | 741,60 |
| 630/1200 | 10211632-1 | 8324307 | 799,33 |
| 800/900 | 10211805-1 | 8324308 | 1156,60 |
| 800/1200 | 10211802-1 | 8324309 | 1308,02 |
| 1000/1200 | 102111002-1 | 8324812 | 1686,25 |

Pyöreä äänenvaimennin kasetilla,
lasikuituhuovalla suojattu
mineraalivilla 100 mm
NRFB 100



| Koko-pituus Ød - L | Tuotekoodi | LVI-koodi | Hinta €-kpl |
|-----------------------|------------|-----------|-------------|
| 315/600 | 10323160 | 8324310 | 479,20 |
| 315/900 | 10323190 | 8324311 | 535,22 |
| 315/1200 | 10211312B | 8324312 | 642,26 |
| 400/600 | 10324060 | 8324455 | 625,15 |
| 400/900 | 10324090 | 8324313 | 661,88 |
| 400/1200 | 103240120 | 8324314 | 705,95 |
| 500/900 | 10211509B | 8324315 | 711,41 |
| 500/1200 | 103250120 | 8324316 | 797,65 |
| 630/600 | 10326360 | 8324317 | 784,29 |
| 630/900 | 10326390 | 8324318 | 1199,61 |
| 630/1200 | 10211632B | 8324319 | 1271,86 |
| 800/900 | 10328090 | 8324320 | 1177,85 |
| 800/1200 | 10211802B | 8324321 | 1625,38 |

Avattava äänenvaimennin, suorakaide-pyöreät
liitokset, lasikuituhuovalla suojattu mineraalivilla
NTFA

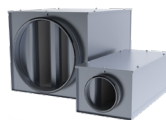

| Koko-pituus Ød - L | Tuotekoodi | LVI-koodi | Hinta €-kpl |
|-----------------------|------------|-----------|-------------|
| 100/300 | 110516030 | 8324864 | 143,72 |
| 100/600 | 110516031 | 8324865 | 158,14 |
| 100/1000 | 110516032 | 8324866 | 231,91 |
| 125/300 | 110516033 | 8324867 | 185,32 |
| 125/600 | 110516034 | 8324868 | 165,33 |
| 125/1000 | 110516035 | 8324869 | 248,66 |
| 160/300 | 110516036 | 8324870 | 155,97 |
| 160/600 | 110516037 | 8324871 | 177,03 |
| 160/1000 | 110516038 | 8324872 | 260,15 |
| 200/300 | 110516039 | 8324873 | 216,54 |
| 200/600 | 110516040 | 8324874 | 232,28 |
| 200/1000 | 110516041 | 8324875 | 288,43 |
| 250/600 | 110516042 | 8324876 | 244,72 |
| 250/1000 | 110516043 | 8324877 | 361,32 |
| 315/600 | 110516044 | 8324878 | 296,79 |
| 315/1000 | 110516045 | 8324879 | 416,64 |
| 400/600 | 110516046 | 8324880 | 398,67 |
| 400/1000 | 110516047 | 8324881 | 532,93 |
| 500/600 | 110516048 | 8324882 | 506,83 |
| 500/1000 | 110516049 | 8324883 | 757,12 |
| 630/600 | 110516050 | 8324884 | 757,12 |
| 630/1000 | 110516051 | 8324885 | 982,30 |

Avattava äänenvaimennin, suorakaide-
pyöreät liitokset, polyesterieriste
NTPA

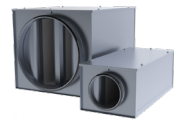

| Koko-pituus Ød - L | Tuotekoodi | LVI-koodi | Hinta €-kpl |
|-----------------------|------------|-----------|-------------|
| 100/300 | 110516052 | 8324886 | 148,10 |
| 100/600 | 110516053 | 8324887 | 159,85 |
| 100/1000 | 110516054 | 8324888 | 235,46 |
| 125/300 | 110516055 | 8324889 | 155,26 • |
| 125/600 | 110516056 | 8324890 | 166,82 • |
| 125/1000 | 110516057 | 8324891 | 250,27 |
| 160/300 | 110516058 | 8324892 | 168,80 |
| 160/600 | 110516059 | 8324893 | 179,05 • |
| 160/1000 | 110516060 | 8324894 | 262,51 • |
| 200/300 | 110516061 | 8324895 | 181,63 |
| 200/600 | 110516062 | 8324896 | 198,86 • |
| 200/1000 | 110516063 | 8324897 | 289,20 • |
| 250/600 | 110516064 | 8324898 | 247,60 • |
| 250/1000 | 110516065 | 8324899 | 354,56 • |
| 315/600 | 110516066 | 8324900 | 298,86 • |
| 315/1000 | 110516067 | 8324901 | 418,80 • |
| 400/600 | 110516068 | 8324902 | 401,42 |
| 400/1000 | 110516069 | 8324903 | 528,22 • |
| 500/600 | 110516070 | 8324904 | 500,44 |
| 500/1000 | 110516071 | 8324905 | 762,52 |
| 630/600 | 110516072 | 8324906 | 762,52 |
| 630/1000 | 110516073 | 8324907 | 991,45 |

NORDsilencer – Äänenvaimentimet

Äänenvaimennin, suorakaide-pyöreät liitokset, lasikuituhuovalla suojattu mineraalivilla
NTF

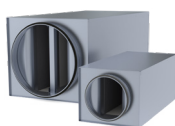

| Koko-pituus Ød - L | Tuotekoodi | LVI-koodi | Hinta €-kpl |
|-----------------------|------------|-----------|----------------|
| 100/300 | 110515001 | 8324842 | 95,48 |
| 100/600 | 110515002 | 8324843 | 118,67 |
| 100/1000 | 110515003 | 8324844 | 176,32 |
| 125/300 | 110515004 | 8324845 | 98,40 |
| 125/600 | 110515005 | 8324846 | 133,57 |
| 125/1000 | 110515006 | 8324847 | 180,66 |
| 160/300 | 110515007 | 8324848 | 110,64 |
| 160/600 | 110515008 | 8324849 | 165,96 |
| 160/1000 | 110515009 | 8324850 | 202,83 |
| 200/300 | 110515010 | 8324851 | 116,61 |
| 200/600 | 110515011 | 8324852 | 169,45 |
| 200/1000 | 110515012 | 8324853 | 234,09 |
| 250/600 | 110515013 | 8324854 | 214,87 |
| 250/1000 | 110515014 | 8324855 | 273,86 |
| 315/600 | 110515015 | 8324856 | 244,46 |
| 315/1000 | 110515016 | 8324857 | 331,51 |
| 400/600 | 110515017 | 8324858 | 311,14 |
| 400/1000 | 110515018 | 8324859 | 466,64 |
| 500/600 | 110515019 | 8324860 | 409,50 |
| 500/1000 | 110515020 | 8324861 | 589,91 |
| 630/600 | 110515021 | 8324862 | 507,70 |
| 630/1000 | 110515022 | 8324863 | 782,94 |

Äänenvaimennin, suorakaide-pyöreät liitokset, polyesterieriste
NTP

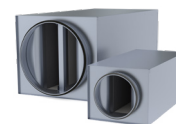

| Koko-pituus Ød - L | Tuotekoodi | LVI-koodi | Hinta €-kpl |
|-----------------------|------------|-----------|----------------|
| 100/300 | 110515030 | 8324820 | 107,15 |
| 100/600 | 110515031 | 8324821 | 122,05 |
| 100/1000 | 110515032 | 8324822 | 176,78 |
| 125/300 | 110515033 | 8324823 | 117,35 |
| 125/600 | 110515034 | 8324824 | 137,24 |
| 125/1000 | 110515035 | 8324825 | 186,50 |
| 160/300 | 110515036 | 8324826 | 126,52 |
| 160/600 | 110515037 | 8324827 | 153,41 |
| 160/1000 | 110515038 | 8324828 | 209,59 |
| 200/300 | 110515039 | 8324829 | 133,97 |
| 200/600 | 110515040 | 8324830 | 165,03 |
| 200/1000 | 110515041 | 8324831 | 232,97 |
| 250/600 | 110515042 | 8324832 | 186,53 |
| 250/1000 | 110515043 | 8324833 | 292,18 |
| 315/600 | 110515044 | 8324834 | 213,01 |
| 315/1000 | 110515045 | 8324835 | 336,55 |
| 400/600 | 110515046 | 8324836 | 328,40 |
| 400/1000 | 110515047 | 8324837 | 483,57 |
| 500/600 | 110515048 | 8324838 | 454,25 |
| 500/1000 | 110515049 | 8324839 | 606,24 |
| 630/600 | 110515050 | 8324840 | 590,18 |
| 630/1000 | 110515051 | 8324841 | 904,30 |

Kulmaäänenvaimennin, liitos sivussa (polyesteri)
NKL



(ilman reikäpeltiä)

| Koko-pituus Ød - L | Tuotekoodi | LVI-koodi | Hinta €-kpl |
|-----------------------|------------|-----------|----------------|
| 100-600 | 110516001 | 8324908 | 149,84 |
| 100-1000 | 110516002 | 8324909 | 220,98 |
| 125-600 | 110516003 | 8324910 | 160,57 |
| 125-1000 | 110516004 | 8324911 | 233,13 |
| 160-600 | 110516005 | 8324912 | 176,42 |
| 160-1000 | 110516006 | 8324913 | 262,00 |
| 200-600 | 110516007 | 8324914 | 193,07 |
| 200-1000 | 110516008 | 8324915 | 291,22 |

Kulmaäänenvaimennin, liitos päällä (polyesteri)
NKU



(ilman reikäpeltiä)

| Koko-pituus Ød - L | Tuotekoodi | LVI-koodi | Hinta €-kpl |
|-----------------------|------------|-----------|----------------|
| 100-600 | 110516010 | 8324916 | 149,84 |
| 100-1000 | 110516011 | 8324917 | 220,98 |
| 125-600 | 110516012 | 8324918 | 160,57 |
| 125-1000 | 110516013 | 8324919 | 233,13 |
| 160-600 | 110516014 | 8324920 | 176,42 |
| 160-1000 | 110516015 | 8324921 | 262,00 |
| 200-600 | 110516016 | 8324922 | 193,07 |
| 200-1000 | 110516017 | 8324923 | 291,22 |

Äänenvaimennin, suorakaide-pyöreät liitokset, polyesterieriste 50 mm
NKE



(ilman reikäpeltiä)

| Koko-pituus Ød - L | Tuotekoodi | LVI-koodi | Hinta €-kpl |
|-----------------------|------------|-----------|----------------|
| 100-600 | 110514001 | 8324277 | 106,38 |
| 100-1000 | 110514005 | 8324281 | 159,10 |
| 125-600 | 110514002 | 8324278 | 111,20 |
| 125-1000 | 110514006 | 8324282 | 166,43 |
| 160-600 | 110514003 | 8324279 | 121,00 |
| 160-1000 | 110514007 | 8324283 | 185,19 |
| 200-600 | 110514004 | 8324280 | 140,46 |
| 200-1000 | 110514008 | 8324284 | 211,96 |

Ilmanvaihtokanavajärjestelmät

NORDsilencer – Äänenvaimentimet

Taipuisa vaimennin
AKU-COMP

| Koko | Pituus | Tuotekoodi | LVI-koodi | Hinta €/kpl | kpl/ laatikko |
|------|---------|------------|-----------|-------------|---------------|
| 100 | 0,3-0,6 | 10820100 | 8324800 | 76,22 | • 96 |
| 125 | 0,3-0,6 | 10820125 | 8324801 | 80,35 | • 70 |
| 160 | 0,3-0,6 | 10820160-1 | 8324802 | 83,35 | • 40 |
| 200 | 0,3-0,6 | 10820200-1 | 8324803 | 122,75 | • 34 |
| 250 | 0,3-0,6 | 10820250-1 | 8324804 | 147,73 | • 22 |
| 315 | 0,3-0,6 | 10820315-1 | 8324805 | 170,87 | • 12 |
| 100 | 1,2 | 10820100-1 | 8324806 | 105,02 | • 60 |
| 125 | 1,2 | 850000021 | 8324807 | 88,26 | • 40 |
| 160 | 1,2 | 10820160 | 8324808 | 98,86 | • 30 |
| 200 | 1,2 | 10820200 | 8324809 | 127,70 | • 21 |
| 250 | 1,2 | 10820250 | 8324810 | 150,50 | • 12 |
| 315 | 1,2 | 10820315 | 8324811 | 180,96 | • 8 |

Suorakaidekanavien äänenvaimentimet

Eristysmateriaalit: polyesteri, Cleantec, lasikuituhuovalla suojattu mineraalivilla
Hinnat tarjouksen mukaan.

| Suorakaideäänenvaimennin MSK/MSP | Suorakaideäänenvaimennin, eristetty MSKI/MSPI | Avattava suorakaideäänenvaimennin MSKA | Kulmaäänenvaimennin MPK |
|---|---|--|---|
|  |  |  |  |

8. NORDroof – Kattojärjestelmät

Ilmanottokatos sadepeltiilitoksella ULS+KL



| Koko Ød + KL | Tuotekoodi | LVI-koodi | Hinta €/kpl |
|-----------------|------------|-----------|----------------|
| 160/400x400 | 2016084 | 8632314 | 1314,40 |
| 200/400x400 | 2016091 | 8632315 | 1425,36 |
| 250/500x500 | 2016107 | 8632316 | 1521,39 |
| 315/500x500 | 2016114 | 8632317 | 2233,19 |
| 400/600x600 | 2016121 | 8632318 | 2451,47 |
| 500/700x700 | 2016138 | 8632319 | 2798,02 |
| 630/800x800 | 2016145 | 8632320 | 3622,61 |
| 800/1000x1000 | 2016183 | 8632321 | 4500,12 |
| 1000/1200x1200 | 2016190 | 8632322 | 6433,75 |
| 1250/1500x1500 | 2016206 | 8632323 | 7311,14 |
| 1600/1800x1800 | 2016213 | 8632324 | 9740,19 |

Ilmanottokatos ULS



| Koko Ød | Tuotekoodi | LVI-koodi | Hinta €/kpl |
|------------|------------|-----------|----------------|
| 160 | 830000902 | 8632046 | 1314,40 |
| 200 | 830000901 | 8632047 | 1425,36 |
| 250 | 830000617 | 8632048 | 1521,39 |
| 315 | 830000354 | 8632049 | 2233,19 |
| 400 | 830000409 | 8632050 | 2451,47 |
| 500 | 830000227 | 8632051 | 2798,02 |
| 630 | 840000102 | 8632052 | 3622,61 |
| 800 | 840000413 | 8632053 | 4500,12 |
| 1000 | 840000101 | 8632054 | 6433,75 |
| 1250 | 840000414 | 8632055 | 7311,14 |

Ilmanottokatos sadepeltiilitoksella URS+KL



| Koko Ød + KL | Tuotekoodi | LVI-koodi | Hinta €/kpl |
|-----------------|------------|-----------|----------------|
| 315/500x500 | 2016220 | 8632325 | 1666,30 |
| 400/600x600 | 2016237 | 8632326 | 1869,78 |
| 500/700x700 | 2016244 | 8632327 | 2272,62 |
| 630/800x800 | 2016251 | 8632328 | 2845,11 |
| 800/1000x1000 | 2016275 | 8632329 | 3426,78 |
| 1000/1200x1200 | 2016381 | 8632330 | 4417,02 |
| 1250/1500x1500 | 2016541 | 8632331 | 5928,54 |

Ilmanottokatos URS



| Koko Ød | Tuotekoodi | LVI-koodi | Hinta €/kpl |
|------------|------------|-----------|----------------|
| 315 | 830500315 | 8632056 | 1666,30 |
| 400 | 830500400 | 8632057 | 1869,78 |
| 500 | 830500500 | 8632058 | 2272,62 |
| 630 | 830500630 | 8632059 | 2845,11 |
| 800 | 830500800 | 8632060 | 3426,78 |
| 1000 | 830501000 | 8632061 | 4417,02 |
| 1250 | 830501250 | 8632062 | 5928,54 |

Ilmanottokatos ULK



Erikoismitat ja -värit tarjouksen mukaan.

| Koko | Tuotekoodi | LVI-koodi | Hinta €/kpl |
|---------------------------------|------------|-----------|----------------|
| ULK 300x300x500 KL-500x500 | 2014981 | 8632365 | 2014,17 |
| ULK 400x400x600 KL-600x600 | 2015025 | 8632366 | 2088,88 |
| ULK 500x500x800 KL-700x700 | 2015049 | 8632367 | 2267,56 |
| ULK 600x600x900 KL-800x800 | 2015087 | 8632368 | 2784,10 |
| ULK 700x700x1100 KL-900x900 | 2015094 | 8632369 | 3359,12 |
| ULK 800x800x1200 KL-1000x1000 | 2015117 | 8632370 | 3563,78 |
| ULK 900x900x1400 KL-1100x1100 | 2015124 | 8632371 | 4294,73 |
| ULK 1000x1000x1500 KL-1200x1200 | 2015131 | 8632372 | 5084,15 |
| ULK 1100x1100x1700 KL-1300x1300 | 2015148 | 8632373 | 5396,01 |
| ULK 1200x1200x1800 KL-1400x1400 | 2015155 | 8632374 | 6159,45 |
| ULK 1300x1300x2000 KL-1500x1500 | 2015162 | 8632375 | 7013,86 |
| ULK 1400x1400x2000 KL-1600x1600 | 2015179 | 8632376 | 7101,56 |
| ULK 1500x1500x2000 KL-1700x1700 | 2015186 | 8632377 | 7806,53 |

Ilmanvaihtokanavajärjestelmät

NORDroof – Kattojärjestelmät

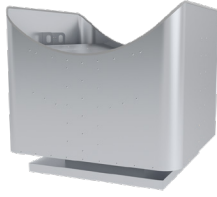
Ulospuhallushajotin
sadepeittäilyksellä
ULV2+KL

| Koko | Tuotekoodi | LVI-koodi | Hinta €/kpl |
|------------------------|------------|-----------|-------------|
| 200x200 KL-400x400 | 2015193 | 8632332 | 540,37 |
| 300x300 KL-500x500 | 2015223 | 8632333 | 1029,96 |
| 400x400 KL-600x600 | 2015230 | 8632334 | 1470,59 |
| 500x500 KL-700x700 | 2015247 | 8632335 | 2071,08 |
| 600x600 KL-800x800 | 2015254 | 8632336 | 2715,10 |
| 800x800 KL-1000x1000 | 2015261 | 8632337 | 3244,32 |
| 1000x1000 KL-1200x1200 | 2015278 | 8632338 | 4174,38 |
| 1200x1200 KL-1400x1400 | 2015285 | 8632339 | 5044,12 |
| 1600x1600 KL-1800x1800 | 2015346 | 8632340 | 10096,46 |

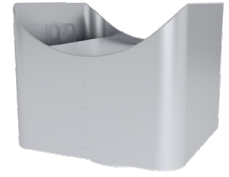
Ulospuhallushajotin
ULV2

| Koko Ød | Tuotekoodi | LVI-koodi | Hinta €/kpl |
|---------|------------|-----------|-------------|
| 160 | 6420160-2 | 8632012 | 430,18 |
| 200 | 6420200-2 | 8632013 | 504,67 |
| 250 | 6420250-2 | 8632014 | 617,71 |
| 315 | 6420315-2 | 8632015 | 971,59 |
| 400 | 6420400-2 | 8632016 | 1370,82 |
| 500 | 6420500-2 | 8632017 | 2095,74 |
| 630 | 6420630-2 | 8632018 | 2822,44 |
| 800 | 6420800-2 | 8632019 | 3682,93 |
| 1000 | 64201000-2 | 8632020 | 4747,23 |
| 1250 | 64201250-2 | 8632021 | 5920,44 |

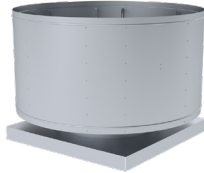
Ilmastointikatos
sadepeittäilyksellä
UVE+KL

| Koko | Tuotekoodi | LVI-koodi | Hinta €/kpl |
|-------------------|------------|-----------|-------------|
| 100 KL-400x400 | 2015711 | 8632341 | 233,50 |
| 125 KL-400x400 | 2015735 | 8632342 | 269,31 |
| 160 KL-400x400 | 2015797 | 8632343 | 289,91 |
| 200 KL-400x400 | 2015803 | 8632344 | 307,77 |
| 250 KL-500x500 | 2015827 | 8632345 | 333,83 |
| 315 KL-500x500 | 2015926 | 8632346 | 572,38 |
| 400 KL-600x600 | 2016015 | 8632347 | 717,38 |
| 500 KL-700x700 | 2016022 | 8632348 | 1150,54 |
| 630 KL-800x800 | 2016039 | 8632349 | 1481,86 |
| 800 KL-1000x1000 | 2016053 | 8632350 | 2131,45 |
| 1000 KL-1200x1200 | 2016060 | 8632351 | 3615,87 |
| 1250 KL-1500x1500 | 2016077 | 8632352 | 4990,59 |

Ilmastointikatos
UVE

| Koko Ød | Tuotekoodi | LVI-koodi | Hinta €/kpl |
|---------|------------|-----------|-------------|
| 100 | 840009010 | 8632000 | 233,50 |
| 125 | 840009012 | 8632001 | 269,31 |
| 160 | 840009016 | 8632002 | 289,91 |
| 200 | 840009020 | 8632003 | 307,77 |
| 250 | 840009025 | 8632004 | 333,83 |
| 315 | 840009031 | 8632005 | 572,38 |
| 400 | 840009040 | 8632006 | 717,38 |
| 500 | 840009050 | 8632007 | 1150,54 |
| 630 | 840009063 | 8632008 | 1481,86 |
| 800 | 840009080 | 8632009 | 2131,45 |
| 1000 | 840009100 | 8632010 | 3563,99 |
| 1250 | 840009125 | 8632011 | 4990,59 |

Ilmastointikatos
UVK+KL

| Koko | Tuotekoodi | LVI-koodi | Hinta €/kpl |
|------------------------|------------|-----------|-------------|
| 300x300 KL-500x500 | 2015353 | 8632353 | 670,38 |
| 400x400 KL-600x600 | 2015360 | 8632354 | 862,40 |
| 500x500 KL-700x700 | 2015391 | 8632355 | 1165,43 |
| 600x600 KL-800x800 | 2015452 | 8632356 | 1440,46 |
| 700x700 KL-900x900 | 2015483 | 8632357 | 1788,74 |
| 800x800 KL-1000x1000 | 2015490 | 8632358 | 2280,36 |
| 900x900 KL-1100x1100 | 2015506 | 8632359 | 2523,10 |
| 1000x1000 KL-1200x1200 | 2015520 | 8632360 | 3189,43 |
| 1100x1100 KL-1300x1300 | 2015551 | 8632361 | 3744,94 |
| 1200x1200 KL-1400x1400 | 2015643 | 8632362 | 4272,08 |
| 1300x1300 KL-1500x1500 | 2015650 | 8632363 | 4895,40 |
| 1400x1400 KL-1600x1600 | 2015667 | 8632364 | 6245,74 |

Sadekatos
NTH

| Koko Ød | Tuotekoodi | LVI-koodi | Hinta €/kpl |
|---------|------------|-----------|-------------|
| 100 | 10210010 | 8632073 | 77,15 • |
| 125 | 10210220 | 8632074 | 80,45 • |
| 160 | 10210260 | 8632075 | 100,26 • |
| 200 | 10210200 | 8632076 | 114,87 • |
| 250 | 10210250 | 8632077 | 133,33 • |
| 315 | 10210310 | 8632078 | 142,15 • |
| 400 | 10210400 | 8632079 | 180,77 • |
| 500 | 10210500 | 8632080 | 310,72 |
| 630 | 10210630 | 8632081 | 405,49 |
| 800 | 10210800 | 8632202 | 887,70 |

NORDroof – Kattojärjestelmät
**Yhdistelmälaite
UHC**

| Koko | Tuotekoodi | LVI-koodi | Hinta €/kpl |
|------|------------|-----------|-------------|
| 200 | 110608001 | 8816843 | 2152,84 |
| 300 | 110608002 | 8816844 | 2220,12 |
| 400 | 110608003 | 8816845 | 2287,42 |
| 500 | 110608004 | 8816846 | 2421,95 |
| 600 | 110608005 | 8816847 | 2691,07 |
| 700 | 110608006 | 8816848 | 2960,16 |
| 800 | 110608007 | 8816849 | 3161,99 |
| 900 | 110608008 | 8816850 | 3294,54 |
| 1000 | 110608009 | 8816851 | 3498,38 |
| 1100 | 110608010 | 8816852 | 3767,47 |

**Kattoläpivienni
UHCT**

| Koko | Tuotekoodi | LVI-koodi | Hinta €/kpl |
|------|------------|-----------|-------------|
| 200 | 110609001 | 7806226 | 912,92 |
| 300 | 110609002 | 7806227 | 949,43 |
| 400 | 110609003 | 7806228 | 1012,35 |
| 500 | 110609004 | 7806229 | 1113,75 |
| 600 | 110609005 | 7806230 | 1271,56 |
| 700 | 110609006 | 7806231 | 1479,70 |
| 800 | 110609007 | 7806232 | 1702,35 |
| 900 | 110609008 | 7806233 | 1891,47 |
| 1000 | 110609009 | 7806234 | 2065,57 |
| 1100 | 110609010 | 7806235 | 2190,99 |

**Kattoläpivienni
MKL-1**

Eriste 50 mm, L=1200



| Koko | Tuotekoodi | Hinta €/kpl |
|-------------------------|------------|-------------|
| MKL-1-50 200x200/1200 | 2836910 | 328,43 |
| MKL-1-50 300x300/1200 | 110613001 | 541,75 |
| MKL-1-50 400x400/1200 | 110613002 | 649,49 |
| MKL-1-50 500x500/1200 | 110613003 | 819,18 |
| MKL-1-50 600x600/1200 | 110613004 | 924,39 |
| MKL-1-50 700x700/1200 | 2960455 | 825,44 |
| MKL-1-50 800x800/1200 | 2986127 | 975,65 |
| MKL-1-50 900x900/1200 | 110613016 | 1126,06 |
| MKL-1-50 1000x1000/1200 | 2934623 | 1273,39 |
| MKL-1-50 1100x1100/1200 | 110613017 | 1555,02 |
| MKL-1-50 1200x1200/1200 | 2855492 | 1879,45 |
| MKL-1-50 1300x1300/1200 | 2826485 | 1600,22 |
| MKL-1-50 1400x1400/1200 | 2883082 | 1709,76 |
| MKL-1-50 1500x1500/1200 | 2924136 | 2581,15 |
| MKL-1-50 1600x1600/1200 | 2982143 | 2176,89 |
| MKL-1-50 1700x1700/1200 | 2934784 | 2294,95 |
| MKL-1-50 1800x1800/1200 | 2916681 | 2414,74 |

**Laippa, kuumasinkitty
VRL**

 Erikoismitat ja -värit tarjouksen mukaan.
 Saatavilla myös haponkestävänä.

| Koko Ød | Tuotekoodi | LVI-koodi | Hinta €/kpl |
|---------|------------|-----------|-------------|
| 100 | 830000446 | 8632082 | 66,09 |
| 125 | 830000447 | 8632083 | 82,61 |
| 160 | 830000448 | 8632084 | 94,05 |
| 200 | 830000449 | 8632085 | 109,29 |
| 250 | 830000194 | 8632086 | 122,30 |
| 315 | 830000195 | 8632087 | 164,49 |

| Koko Ød | Tuotekoodi | LVI-koodi | Hinta €/kpl |
|---------|------------|-----------|-------------|
| 400 | 830000450 | 8632088 | 207,31 |
| 500 | 830000057 | 8632032 | 278,04 • |
| 630 | 830000198 | 8632033 | 358,24 • |
| 800 | 830000199 | 8632034 | 451,83 • |
| 1000 | 830000200 | 8632035 | 708,57 • |
| 1250 | 830000201 | 8632036 | 816,39 • |

Ilmanvaihtokanavajärjestelmät

NORDroof – Kattojärjestelmät

Alipainepeltili MKLK

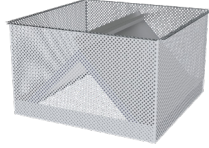

| Koko | Tuotekoodi | LVI-koodi | Hinta €/kpl |
|---------|------------|-----------|-------------|
| 200x200 | 2017500 | 7806341 | 129,87 |
| 300x300 | 2017517 | 7806342 | 147,20 |
| 400x400 | 2017524 | 7806343 | 165,61 |
| 500x500 | 2017548 | 7806344 | 185,22 |
| 600x600 | 2017562 | 7806345 | 206,06 |
| 700x700 | 2017586 | 7806346 | 229,64 |
| 800x800 | 2017685 | 7806347 | 252,73 |
| 900x900 | 2017760 | 7806348 | 278,31 |

| Koko | Tuotekoodi | LVI-koodi | Hinta €/kpl |
|-----------|------------|-----------|-------------|
| 1000x1000 | 2017852 | 7806349 | 303,54 |
| 1100x1100 | 2017944 | 7806350 | 330,00 |
| 1200x1200 | 2018156 | 7806351 | 357,52 |
| 1300x1300 | 2018163 | 7806352 | 386,26 |
| 1400x1400 | 2018170 | 7806353 | 416,23 |
| 1500x1500 | 2018217 | 7806354 | 447,09 |
| 1600x1600 | 2018224 | 7806355 | 479,33 |

Pyöreä liitin kattoläpivientiin MKLV



| Koko | Tuotekoodi | LVI-koodi | Hinta €/kpl |
|----------------|------------|-----------|-------------|
| 400x400/100 | 2018583 | 7806276 | 43,35 |
| 500x500/100 | 2909973 | | 42,36 |
| 400x400/125 | 2018620 | 7806277 | 43,35 |
| 500x500/125 | 2018668 | 7806281 | 50,19 |
| 400x400/160 | 2018637 | 7806278 | 43,65 |
| 500x500/160 | 2018675 | 7806282 | 50,49 |
| 400x400/200 | 2846803 | | 36,85 |
| 500x500/200 | 2018682 | 7806283 | 50,79 |
| 500x500/250 | 2018699 | 7806284 | 51,55 |
| 600x600/250 | 2018712 | 7806286 | 59,47 |
| 500x500/315 | 110614014 | 7806240 | 43,87 |
| 600x600/315 | 2910719 | | 69,35 |
| 700x700/315 | 2018743 | 7806289 | 69,04 |
| 600x600/400 | 110614015 | 7806241 | 73,13 |
| 700x700/400 | 2200438 | | 87,20 |
| 800x800/400 | 2018774 | 7806292 | 81,21 |
| 700x700/500 | 2819241 | | 92,26 |
| 800x800/500 | 2887264 | | 108,16 |
| 900x900/500 | 2200452 | | 125,92 |
| 800x800/630 | 2855904 | | 113,13 |
| 900x900/630 | 2200469 | | 130,89 |
| 1000x1000/500 | 2018835 | 7806297 | 111,93 |
| 1000x1000/630 | 2200476 | | 150,47 |
| 1000x1000/800 | 2955680 | | 299,97 |
| 1100x1100/800 | 2200490 | | 342,77 |
| 1200x1200/800 | 2018996 | 7806301 | 289,25 |
| 1200x1200/1000 | 2878675 | | 406,04 |
| 1300x1300/1000 | 2200506 | | 456,21 |
| 1400x1400/1000 | 2019030 | 7806304 | 367,11 |
| 1400x1400/1250 | 2019047 | 7806305 | 376,53 |
| 1500x1500/1250 | 2200513 | | 579,91 |
| 1600x1600/1250 | 2200537 | | 641,05 |
| 1700x1700/1250 | 2200520 | | 705,96 |
| 1800x1800/1250 | 2019085 | 7806309 | 534,68 |
| 1800x1800/1600 | 2019092 | 7806310 | 556,28 |
| 1900x1900/1600 | 2019108 | 7806311 | 601,30 |

Alipainepeltili MKLU



| Koko | Tuotekoodi | LVI-koodi | Hinta €/kpl |
|----------------|------------|-----------|-------------|
| 200x200/100 | 2018231 | 7806312 | 74,67 |
| 200x200/125 | 2018255 | 7806313 | 74,67 |
| 200x200/160 | 2018262 | 7806314 | 75,13 |
| 200x200/200 | 2018279 | 7806315 | 75,87 |
| 300x300/200 | 2018316 | 7806316 | 86,52 |
| 300x300/250 | 2018323 | 7806317 | 87,29 |
| 400x400/200 | 2018330 | 7806319 | 98,54 |
| 400x400/250 | 2018347 | 7806320 | 99,01 |
| 400x400/315 | 2018354 | 7806321 | 98,85 |
| 400x400/400 | 2018361 | 7806322 | 100,83 |
| 500x500/315 | 2018378 | 7806323 | 111,31 |
| 500x500/400 | 2018385 | 7806324 | 112,07 |
| 500x500/500 | 2018392 | 7806325 | 113,75 |
| 600x600/400 | 2018415 | 7806326 | 128,65 |
| 600x600/500 | 2018422 | 7806327 | 128,82 |
| 700x700/500 | 2018439 | 7806329 | 146,14 |
| 700x700/630 | 2018446 | 7806330 | 143,71 |
| 800x800/630 | 2018453 | 7806331 | 167,88 |
| 800x800/800 | 2018460 | 7806332 | 180,05 |
| 900x900/800 | 2018477 | 7806333 | 208,34 |
| 1000x1000/1000 | 2018484 | 7806334 | 254,57 |
| 1100x1100/1000 | 2018507 | 7806335 | 281,95 |
| 1200x1200/1000 | 2018514 | 7806336 | 309,02 |
| 1300x1300/1250 | 2018521 | 7806337 | 323,31 |
| 1400x1400/1250 | 2018538 | 7806338 | 350,98 |
| 1500x1500/1250 | 2018545 | 7806339 | 386,57 |
| 1600x1600/1600 | 2018576 | 7806340 | 397,67 |

9. NORDexternal – Ulkosäleiköt ja lumisuojat

Ulkosäleikkö

RV



Mitat: leveys x korkeus

Vakioväri RAL7000

Erikoismitat ja -värit tarjouksen mukaan.

| Korkeus | Leveys | | | | | | | | | | | | |
|---------|--------|---------|---------|---------|---------|---------|---------|---------|---------|---------|---------|---------|---------|
| | 200 | 300 | 400 | 500 | 600 | 700 | 800 | 1000 | 1200 | 1400 | 1600 | 1800 | 2000 |
| 200 | 377,00 | 392,57 | 407,68 | 423,16 | 438,36 | 453,84 | 469,14 | 500,85 | 531,62 | 733,17 | 764,03 | 797,25 | 828,02 |
| 300 | 401,20 | 419,88 | 438,55 | 457,22 | 475,89 | 494,56 | 513,42 | 552,27 | 589,61 | 812,82 | 850,26 | 890,61 | 928,14 |
| 400 | 425,32 | 447,27 | 469,42 | 491,37 | 513,42 | 535,38 | 557,52 | 603,50 | 647,60 | 892,39 | 936,30 | 984,53 | 1028,44 |
| 500 | 449,43 | 474,86 | 500,10 | 525,53 | 550,95 | 576,29 | 601,53 | 654,82 | 705,49 | 971,58 | 1022,62 | 1077,98 | 1128,74 |
| 600 | | 502,35 | 531,06 | 559,77 | 588,48 | 617,20 | 645,81 | 706,14 | 763,47 | 1051,24 | 1108,57 | 1171,43 | 1229,04 |
| 800 | | 557,33 | 592,61 | 628,17 | 663,55 | 698,92 | 734,29 | 808,60 | 879,35 | 1210,37 | 1281,02 | 1358,62 | 1429,46 |
| 1000 | | 612,22 | 654,35 | 696,48 | 738,70 | 780,55 | 822,68 | 911,06 | 995,22 | 1369,03 | 1453,01 | 1545,71 | 1630,15 |
| 1200 | | 667,30 | 716,00 | 764,79 | 813,67 | 862,27 | 911,06 | 1013,71 | 1111,10 | 1527,79 | 1625,27 | 1732,99 | 1830,38 |
| 1400 | | 741,23 | 796,50 | 852,14 | 907,68 | 962,95 | 1018,40 | 1083,23 | 1246,12 | 1713,38 | 1824,28 | 1946,82 | 2057,54 |
| 1600 | | 935,93 | 1003,76 | 1071,60 | 1139,53 | 1207,56 | 1275,30 | 1134,93 | 1553,21 | 2173,32 | 2308,99 | 2458,83 | 2593,66 |
| 1800 | | 990,81 | 1065,69 | 1139,91 | 1214,78 | 1288,90 | 1363,68 | 1417,63 | 1669,37 | 2332,36 | 2481,17 | 2645,74 | 2794,45 |
| 2000 | | 1045,89 | 1127,43 | 1208,59 | 1289,75 | 1370,91 | 1451,79 | 1520,38 | 1785,06 | 2491,02 | 2653,34 | 2832,55 | 2994,78 |

Ulkosäleikkö

RV-D2

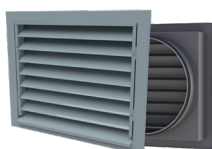

Mitat: leveys x korkeus - halkaisija

Vakioväri RAL7000

Erikoismitat ja -värit tarjouksen mukaan.

| Koko B x H | D2 | Tuotekoodi | LVI-koodi | Hinta €/kpl |
|------------|-----|---------------|-----------|-------------|
| 200x200 | 125 | 501020020-125 | 8816601 | 481,71 |
| 200x200 | 160 | 501020020-160 | 8816602 | 483,68 |
| 250x250 | 200 | 501025025-200 | 8816603 | 509,39 |
| 300x300 | 250 | 501030030-250 | 8816607 | 540,16 |
| 400x400 | 315 | 501040040-315 | 8816612 | 592,24 |
| 450x450 | 400 | 501045045-400 | 8816613 | 629,02 |

Lumisuoja

RVR

Vakioväri RAL7000

Erikoismitat ja -värit tarjouksen mukaan.

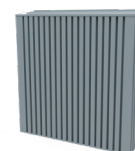

Lumisuoja, upotettava

RVLU

Vakioväri RAL7000.

Erikoismitat ja -värit tarjouksen mukaan.



Yhdistetty ulko- ja poistoilmalaitte

RVD

Vakioväri RAL7000

| Koko Ød | Tuotekoodi | LVI-koodi | Hinta €/kpl |
|---------|------------|-----------|-------------|
| 125 | 901100320 | 8816853 | 408,61 |
| 125L | 901100324 | 8741226 | 492,10 |
| 160 | 901100321 | 8816854 | 492,15 |
| 200 | 901100322 | 8816855 | 577,49 |
| 250 | 901100323 | 8816856 | 715,84 |
| 250L | 901100325 | 8741227 | 839,63 |

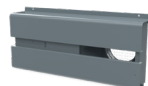

Ulkosäleikkö lämmitettävillä säleillä

RVUK

Vakioväri RAL7000.

Erikoismitat ja -värit tarjouksen mukaan.



Ulkosäleikkö

RVA

Valettu alumiinista

| Koko | Tuotekoodi | LVI-koodi | Hinta €/kpl |
|---------|------------|-----------|-------------|
| 100 | 5030100 | 8816825 | 7,69 • |
| 125 | 5030125 | 8816826 | 9,40 • |
| 160 | 5030160 | 8816827 | 16,06 • |
| 200 | 5030200 | 8816828 | 19,09 • |
| 250 | 5030250 | 8816829 | 36,27 • |
| 315 | 5030315 | 8816830 | 55,74 • |
| 400 | 5030400 | 8816831 | 112,15 • |
| 100x100 | 503100100 | 8816832 | 27,79 |
| 150x150 | 503150150 | 8816833 | 39,11 |
| 200x200 | 503200200 | 8816834 | 59,31 |



RVDS Tuloilmäsäleikkö

| Koko | Tuotekoodi | LVI-koodi | Hinta €/kpl |
|------|------------|-----------|-------------|
| 125 | 901100330 | 8741228 | 334,56 |
| 160 | 901100331 | 8741229 | 401,20 |
| 200 | 901100332 | 8741230 | 466,19 |
| 250 | 901100333 | 8741231 | 566,23 |

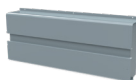

RVDV Poistoilmäsäleikkö

| Koko | Tuotekoodi | LVI-koodi | Hinta €/kpl |
|------|------------|-----------|-------------|
| 125 | 901100340 | 8741232 | 361,32 |
| 160 | 901100341 | 8741233 | 430,12 |
| 200 | 901100342 | 8741234 | 505,57 |
| 250 | 901100343 | 8741235 | 628,38 |



Ilmanvaihtokanavajärjestelmät

10. Pyöreä kanavajärjestelmä, 1,25 mm

Kierresaumakanava,
Pituus 3 m
NTO-S 1,2

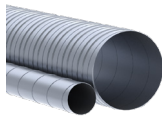

| Koko Ød | Tuotekoodi | LVI-koodi | Hinta €/m |
|---------|------------|-----------|-----------|
| 100 | 840000039 | 8103141 | 42,33 |
| 125 | 840000023 | 8103142 | 51,80 |
| 160 | 840000038 | 8103143 | 59,32 • |
| 200 | 840000239 | 8103144 | 76,12 • |
| 250 | 840000238 | 8103145 | 93,09 • |
| 315 | 840000219 | 8103146 | 114,06 • |
| 400 | 840000077 | 8103147 | 166,79 • |
| 500 | 840000192 | 8103148 | 181,34 • |
| 630 | 840000228 | 8103149 | 277,15 • |
| 800 | 840000229 | 8103150 | 345,89 • |
| 1000 | 840000231 | 8103151 | 499,40 |
| 1250 | 840000233 | 8103152 | 623,73 |

Käyrä 45°
NV-S 1,2



| Koko Ød | Tuotekoodi | LVI-koodi | Hinta €/kpl |
|---------|-------------|-----------|-------------|
| 125 | 830000465-5 | 8113017 | 138,67 |
| 160 | 830001650 | 8113018 | 142,07 • |
| 200 | 83012245 | 8113019 | 159,68 • |
| 250 | 830122545 | 8113020 | 177,84 • |
| 315 | 83202315 | 8113021 | 201,58 • |
| 400 | 83202404 | 8113022 | 244,04 • |
| 500 | 8301277 | 8113023 | 289,19 • |
| 630 | 8301211 | 8113024 | 423,94 • |
| 800 | 8301220 | 8113025 | 576,80 • |
| 1000 | 8301218 | 8113026 | 1146,35 |
| 1250 | 8301212 | 8113027 | 1568,83 |

Käyrä 90°
NV-S 1,2



| Koko Ød | Tuotekoodi | LVI-koodi | Hinta €/kpl |
|---------|------------|-----------|-------------|
| 100 | 83202019 | 8113001 | 145,57 |
| 125 | 830000236 | 8113002 | 149,55 • |
| 160 | 83202169 | 8113003 | 156,74 • |
| 200 | 8301224 | 8113004 | 179,72 • |
| 250 | 8301223 | 8113005 | 217,46 • |
| 315 | 830000160 | 8113006 | 249,80 • |
| 400 | 8301219 | 8113007 | 340,29 • |
| 500 | 8301276 | 8113008 | 452,79 • |
| 630 | 8301210 | 8113009 | 559,25 • |
| 800 | 8301216 | 8113010 | 782,87 • |
| 1000 | 8301217 | 8113011 | 1526,35 |
| 1250 | 8301213 | 8113012 | 2187,62 |

Sisäliitin
NI-S 1,2



| Koko Ød | Tuotekoodi | LVI-koodi | Hinta €/kpl |
|---------|------------|-----------|-------------|
| 100 | 830001651 | 8113090 | 31,65 |
| 125 | 83203120 | 8113091 | 31,95 |
| 160 | 83203160 | 8113092 | 32,84 • |
| 200 | 83203200 | 8113093 | 37,09 • |
| 250 | 83203251 | 8113094 | 44,61 • |
| 315 | 83203311 | 8113095 | 47,27 • |
| 400 | 83203400 | 8113096 | 59,54 • |
| 500 | 8301279 | 8113097 | 73,86 • |
| 630 | 8301221 | 8113098 | 86,50 • |
| 800 | 8301214 | 8113099 | 133,40 • |
| 1000 | 830001252 | 8113100 | 192,22 |
| 1250 | 8301215 | 8113101 | 235,57 |

Ulkoliitin
NM-S 1,2



| Koko Ød | Tuotekoodi | LVI-koodi | Hinta €/kpl |
|---------|------------|-----------|-------------|
| 100 | 830001652 | 8113105 | 29,58 |
| 125 | 830001653 | 8113106 | 30,16 |
| 160 | 830001654 | 8113107 | 30,78 |
| 200 | 830001655 | 8113108 | 31,41 |
| 250 | 830001656 | 8113109 | 33,68 |
| 315 | 830001657 | 8113110 | 39,02 |
| 400 | 830001658 | 8113111 | 46,55 |
| 500 | 830001659 | 8113112 | 54,72 |
| 630 | 830001660 | 8113113 | 64,48 |
| 800 | 830001661 | 8113114 | 102,29 |
| 1000 | 830001662 | 8113115 | 141,90 |
| 1250 | 830001663 | 8113116 | 200,14 |

Lähtökaulus tasopinnalle
NSK-S 1,2



| Koko Ød | Tuotekoodi | LVI-koodi | Hinta €/kpl |
|---------|------------|-----------|-------------|
| 100 | 830001664 | 8113121 | 30,78 |
| 125 | 830001665 | 8113122 | 33,68 |
| 160 | 830001666 | 8113123 | 34,80 • |
| 200 | 830000165 | 8113124 | 35,74 • |
| 250 | 830001667 | 8113125 | 43,57 • |
| 315 | 830000164 | 8113126 | 47,85 • |
| 400 | 8320400 | 8113127 | 54,02 • |
| 500 | 83205500 | 8113128 | 60,06 • |
| 630 | 83205600 | 8113129 | 71,55 • |
| 800 | KP00030 | 8113130 | 155,82 |
| 1000 | 83205601 | 8113131 | 194,30 |
| 1250 | 830001668 | 8113132 | 234,99 |

Tulppa kanavalle
NAL-S 1,2



| Koko Ød | Tuotekoodi | LVI-koodi | Hinta €/kpl |
|---------|------------|-----------|-------------|
| 125 | 830001786 | 8113137 | 64,26 |
| 160 | 830001787 | 8113138 | 64,90 |
| 200 | 830001788 | 8113139 | 65,56 • |
| 250 | 10208250-3 | 8113140 | 74,56 • |
| 315 | 83208315 | 8113141 | 84,92 • |
| 400 | 83208400 | 8113142 | 99,04 • |
| 500 | 83208500 | 8113143 | 115,06 • |
| 630 | 83208630 | 8113144 | 133,56 • |
| 800 | 83208800 | 8113145 | 198,70 |
| 1000 | 83012100 | 8113146 | 279,01 |
| 1250 | 8301280 | 8113147 | 390,09 |

Tulppa osalle
NALM-S 1,2



| Koko Ød | Tuotekoodi | LVI-koodi | Hinta €/kpl |
|---------|------------|-----------|-------------|
| 125 | 10208125-0 | 8113151 | 62,56 |
| 160 | 10208200-4 | 8113152 | 63,81 |
| 200 | 830001796 | 8113153 | 65,05 |
| 250 | 830001797 | 8113154 | 68,55 |
| 315 | 830001798 | 8113155 | 78,21 |
| 400 | 830001799 | 8113156 | 88,71 |
| 500 | 830001800 | 8113157 | 108,53 |
| 630 | 10208630-3 | 8113158 | 127,19 |
| 800 | 830001801 | 8113159 | 199,33 |
| 1000 | 8300018891 | 8113160 | 279,01 |
| 1250 | 830001802 | 8113161 | 390,09 |

Pyöreä kanavajärjestelmä, 1,25 mm

**Muunto,
epäkeskeinen,
osakoko
NFB-S 1,2**



**Lähtökaulus,
lyhyt kaulus
NPSK-S 1,2**

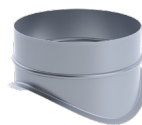

**Lähtökaulus
NPSV-S 1,2**

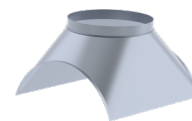

| Koko Ød1-d2 | Tuotekoodi | LVI- koodi | Hinta €/kpl |
|----------------|------------|---------------|----------------|
| 125/100 | 830001843 | 8113205 | 171,24 |
| 160/100 | 830001844 | 8113206 | 176,46 |
| 160/125 | 830001845 | 8113207 | 178,80 |
| 200/100 | 830001846 | 8113210 | 182,71 |
| 200/125 | 830001847 | 8113208 | 183,99 |
| 200/160 | 830001848 | 8113209 | 184,95 |
| 250/100 | 830001849 | 8113375 | 206,24 |
| 250/125 | 830001850 | 8113212 | 212,03 |
| 250/160 | 830001851 | 8113213 | 214,64 |
| 250/200 | 830001852 | 8113214 | 218,43 |
| 315/125 | 830001083 | 8113217 | 232,98 |
| 315/160 | 830001853 | 8113218 | 233,93 |
| 315/200 | 830001854 | 8113219 | 238,75 |
| 315/250 | 830001855 | 8113220 | 249,64 • |
| 400/125 | 830001856 | 8113376 | 274,48 |
| 400/160 | 830001857 | 8113377 | 279,44 |
| 400/200 | 830001858 | 8113225 | 281,93 |
| 400/250 | 830001859 | 8113226 | 291,86 |
| 400/315 | 830001860 | 8113227 | 297,89 • |
| 500/125 | 830001861 | 8113378 | 267,29 |
| 500/160 | 830001862 | 8113379 | 313,88 |
| 500/200 | 830001863 | 8113232 | 326,28 |
| 500/250 | 830001864 | 8113233 | 337,51 |
| 500/315 | 830001865 | 8113234 | 337,51 |
| 500/400 | 83209504-2 | 8113235 | 337,51 • |
| 630/160 | 830001866 | 8113380 | 409,17 |
| 630/200 | 830001867 | 8113240 | 409,17 |
| 630/250 | 830001868 | 8113241 | 409,17 |
| 630/315 | 830001869 | 8113242 | 409,17 |
| 630/400 | 830001870 | 8113243 | 416,39 |
| 630/500 | 8301278 | 8113244 | 418,53 • |
| 800/315 | 830001871 | 8113251 | 660,59 |
| 800/400 | 830001872 | 8113252 | 660,59 |
| 800/500 | 83209505-3 | 8113253 | 614,23 |
| 800/630 | 83209505-2 | 8113254 | 614,23 |
| 1000/315 | 830001873 | 8113381 | 697,66 |
| 1000/400 | 830001874 | 8113261 | 722,11 |
| 1000/500 | 830001875 | 8113255 | 766,92 |
| 1000/630 | 830001876 | 8113256 | 833,61 |
| 1000/800 | 83012525 | 8113257 | 766,92 |
| 1250/400 | 830001877 | 8113262 | 1132,23 |
| 1250/500 | 830001878 | 8113263 | 1044,11 |
| 1250/630 | 830001879 | 8113258 | 1154,79 |
| 1250/800 | 830001880 | 8113259 | 1160,37 |
| 1250/1000 | 8301253 | 8113260 | 1160,37 |

| Koko ØD-d | Tuotekoodi | LVI- koodi | Hinta €/kpl |
|--------------|------------|---------------|----------------|
| 100/100 | 83206010-1 | 8113300 | 62,81 |
| 125/100 | 830001681 | 8113301 | 64,01 |
| 125/125 | 83206121-2 | 8113302 | 67,79 |
| 160/100 | 83206160-1 | 8113303 | 61,66 |
| 160/125 | 83206161-2 | 8113304 | 63,58 |
| 160/160 | 83206161-6 | 8113305 | 64,99 |
| 200/100 | 830001682 | 8113500 | 61,93 |
| 200/125 | 830001683 | 8113306 | 65,32 |
| 200/160 | 830001684 | 8113307 | 65,65 |
| 200/200 | 830001685 | 8113308 | 69,86 |
| 250/100 | 830001686 | 8113501 | 62,76 |
| 250/125 | 830001687 | 8113502 | 64,07 |
| 250/160 | 830001688 | 8113309 | 65,48 |
| 250/200 | 830001689 | 8113310 | 68,99 |
| 250/250 | 830001690 | 8113311 | 81,79 |
| 315/100 | 830001691 | 8113503 | 62,21 |
| 315/125 | 830000238 | 8113504 | 63,58 |
| 315/160 | 830001692 | 8113312 | 65,22 |
| 315/200 | 830001693 | 8113313 | 69,53 |
| 315/250 | 830001694 | 8113314 | 81,79 |
| 315/315 | 10206313-3 | 8113315 | 88,69 |
| 400/100 | 830001695 | 8113505 | 61,82 |
| 400/125 | 830001696 | 8113506 | 62,92 |
| 400/160 | 830001697 | 8113507 | 65,22 |
| 400/200 | 830000163 | 8113316 | 67,79 |
| 400/250 | 830001698 | 8113317 | 71,45 |
| 400/315 | 110935055 | 8113527 | 71,35 |
| 500/160 | 83206501-6 | 8113508 | 65,22 |
| 500/200 | 10206502-2 | 8113509 | 67,35 |
| 500/250 | 830001699 | 8113320 | 69,86 |
| 500/315 | 830001700 | 8113321 | 78,30 |
| 630/125 | 830001702 | 8113511 | 63,62 |
| 630/160 | 830001703 | 8113512 | 65,22 |
| 630/200 | 830001704 | 8113513 | 68,12 |
| 630/250 | 830001705 | 8113514 | 70,80 |
| 630/315 | 830001706 | 8113551 | 78,30 |
| 800/160 | 830001708 | 8113516 | 111,66 |
| 800/200 | 830001709 | 8113517 | 66,91 |
| 800/250 | 830001710 | 8113518 | 71,23 |
| 800/315 | 830001711 | 8113519 | 75,83 |
| 1000/160 | 830001713 | 8113521 | 67,67 |
| 1000/200 | 830001714 | 8113522 | 68,45 |
| 1000/250 | 830001715 | 8113523 | 71,02 |
| 1000/315 | 830001716 | 8113524 | 77,52 |
| 1250/250 | 830001717 | 8113525 | 77,52 |
| 1250/315 | 830001718 | 8113526 | 83,88 |

| Koko ØD-d | Tuotekoodi | LVI- koodi | Hinta €/kpl |
|--------------|------------|---------------|----------------|
| 400/400 | 830001719 | 8113319 | 172,77 |
| 500/400 | 830001720 | 8113322 | 181,26 |
| 500/500 | 830001721 | 8113323 | 215,01 |
| 630/400 | 830001722 | 8113325 | 206,65 |
| 630/500 | 830001723 | 8113326 | 245,16 |
| 630/630 | 830001724 | 8113327 | 298,34 |
| 800/400 | 830001725 | 8113328 | 220,10 |
| 800/500 | 830001726 | 8113329 | 256,65 |
| 800/630 | 830001727 | 8113330 | 325,92 |
| 800/800 | 830001728 | 8113331 | 418,65 |
| 1000/400 | 830001729 | 8113351 | 223,61 |
| 1000/500 | 830001730 | 8113332 | 262,99 |
| 1000/630 | 830001731 | 8113333 | 323,07 |
| 1000/800 | 830001732 | 8113334 | 429,43 |
| 1000/1000 | 830001733 | 8113335 | 694,01 |
| 1250/400 | 830001734 | 8113353 | 280,67 |
| 1250/500 | 830001735 | 8113354 | 330,84 |
| 1250/630 | 10206156-6 | 8113336 | 382,59 |
| 1250/800 | 830001736 | 8113337 | 519,87 |
| 1250/1000 | 830001737 | 8113338 | 757,53 |
| 1250/1250 | 830001738 | 8113339 | 973,97 |

Ilmanvaihtokanavajärjestelmät

Pyöreä kanavajärjestelmä, 1,25 mm

T-yhde NTK-S 1,2



| Koko Ød1-d2 | Tuotekoodi | LVI- koodi | Hinta €/kpl |
|----------------|-------------|---------------|----------------|
| 100/100 | 830001739 | 8113414 | 134,94 |
| 125/100 | 830001740 | 8113415 | 138,39 |
| 125/125 | 831000501-0 | 8113416 | 143,28 |
| 160/100 | 830001741 | 8113417 | 139,37 |
| 160/125 | EK00457 | 8113418 | 142,16 |
| 160/160 | 830001742 | 8113419 | 145,10 |
| 200/100 | 830001743 | 8113421 | 142,81 |
| 200/125 | 830001744 | 8113422 | 147,89 |
| 200/160 | EK00458 | 8113423 | 149,87 |
| 200/200 | 102072020 | 8113424 | 156,57 |
| 250/100 | 830001745 | 8113426 | 147,74 |
| 250/125 | 830001746 | 8113427 | 150,68 |
| 250/160 | 830001747 | 8113428 | 155,42 |
| 250/200 | EK00459 | 8113429 | 161,35 |
| 250/250 | 830001748 | 8113430 | 176,45 |
| 315/100 | 830001749 | 8113432 | 151,50 |
| 315/125 | 830001750 | 8113433 | 157,74 |
| 315/160 | 830001751 | 8113434 | 161,67 |
| 315/200 | 102073120 | 8113435 | 175,93 |
| 315/250 | 102073125 | 8113436 | 187,71 |
| 315/315 | 102073131 | 8113437 | 234,39 |
| 400/100 | 830001752 | 8113439 | 167,58 |
| 400/125 | 830001753 | 8113440 | 168,88 |
| 400/160 | 830001754 | 8113441 | 176,76 |
| 400/200 | 830001755 | 8113442 | 185,11 |

T-yhde NTKV-S 1,2

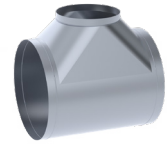

| Koko Ød1-d2 | Tuotekoodi | LVI- koodi | Hinta €/kpl |
|----------------|------------|---------------|----------------|
| 400/250 | 830001756 | 8113443 | 216,54 |
| 400/315 | 102074040 | 8113444 | 254,73 |
| 500/100 | 830001757 | 8113447 | 261,25 |
| 500/125 | 830001758 | 8113448 | 304,36 |
| 500/160 | 830001759 | 8113449 | 304,36 |
| 500/200 | 830001760 | 8113450 | 311,91 |
| 500/250 | 10500250 | 8113451 | 330,84 |
| 500/315 | EK00964 | 8113452 | 343,75 |
| 630/100 | 830001761 | 8113456 | 363,67 |
| 630/125 | 830001762 | 8113457 | 371,98 |
| 630/160 | 830001763 | 8113458 | 402,73 |
| 630/200 | 830001764 | 8113459 | 420,02 |
| 630/250 | 830001765 | 8113460 | 440,91 |
| 630/315 | 10630315 | 8113461 | 455,75 |
| 800/160 | 830001766 | 8113468 | 274,54 |
| 800/200 | 830001767 | 8113469 | 286,09 |
| 800/250 | 830001768 | 8113470 | 301,73 |
| 800/315 | 830001769 | 8113471 | 312,50 |
| 1000/160 | 830001773 | 8113484 | 300,20 |
| 1000/200 | 830001774 | 8113485 | 314,86 |
| 1000/250 | 830001775 | 8113486 | 331,93 |
| 1000/315 | 830001776 | 8113487 | 351,14 |
| 1250/250 | 830001779 | 8113489 | 369,68 |
| 1250/315 | 830001780 | 8113490 | 389,98 |

| Koko Ød1-d2 | Tuotekoodi | LVI- koodi | Hinta €/kpl |
|----------------|------------|---------------|----------------|
| 400/400 | 10207404-2 | 8113445 | 353,76 |
| 500/400 | EK00965 | 8113453 | 492,27 |
| 500/500 | EK00564 | 8113454 | 533,13 |
| 630/400 | EK00966 | 8113462 | 685,34 |
| 630/500 | 10630316 | 8113463 | 740,82 |
| 630/630 | 10630316-6 | 8113464 | 821,11 |
| 800/400 | 830001770 | 8113472 | 946,25 |
| 800/500 | 830001771 | 8113473 | 1085,19 |
| 800/630 | 830001772 | 8113474 | 1200,90 |
| 800/800 | 83000067-8 | 8113475 | 1366,63 |
| 1000/400 | 830001777 | 8113488 | 1374,46 |
| 1000/500 | 831000500 | 8113476 | 1395,86 |
| 1000/630 | 830001778 | 8113477 | 1654,87 |
| 1000/800 | 83000067-0 | 8113478 | 1841,16 |
| 1000/1000 | 110938062 | 8113479 | 2610,67 |
| 1250/400 | 830001781 | 8113491 | 1844,67 |
| 1250/500 | 830001782 | 8113492 | 2000,27 |
| 1250/630 | 830001783 | 8113480 | 2255,25 |
| 1250/800 | 830001784 | 8113481 | 2342,27 |
| 1250/1000 | 831000502 | 8113482 | 2648,13 |
| 1250/1250 | 831000501 | 8113483 | 3689,60 |

Imukartio suojaverkolla NK-S 1,2



| Koko Ød | Tuotekoodi | LVI- koodi | Hinta €/kpl |
|------------|------------|---------------|----------------|
| 100 | 10206011 | 8113912 | 72,88 |
| 125 | 10206012 | 8113913 | 74,94 |
| 160 | 10206016 | 8113914 | 77,49 |
| 200 | 10206200-2 | 8113915 | 83,39 |
| 250 | 10206250-2 | 8113916 | 90,72 |
| 315 | 10206031 | 8113917 | 101,75 |
| 400 | 10206404 | 8113918 | 139,85 |
| 500 | 10206500-0 | 8113919 | 163,61 |
| 630 | 102066630 | 8113920 | 194,15 |
| 800 | 10206800 | 8113921 | 252,66 |
| 1000 | 102061000 | 8113922 | 340,55 |
| 1250 | 102061250 | 8113923 | 404,84 |

Säätöpelti KROS-S 1,2



| Koko Ød | Tuotekoodi | LVI- koodi | Hinta €/kpl |
|------------|------------|---------------|----------------|
| 100 | 840000448 | 8406486 | 213,49 |
| 125 | 840000450 | 8406487 | 218,87 |
| 160 | 840000452 | 8406488 | 224,24 |
| 200 | 840000453 | 8406489 | 255,63 |
| 250 | 840000454 | 8406490 | 258,34 |
| 315 | 840000247 | 8406491 | 301,39 |
| 400 | 840000248 | 8406492 | 409,04 |

11. Pyöreä kanavajärjestelmä, Magnelis (ZM310)

**Kierresaumakanava,
pituus 3 m
NTO-ZM**

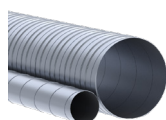

| Koko Ød | Tuotekoodi | LVI-koodi | Hinta €/m |
|---------|------------|-----------|-----------|
| 80 | 111260001 | 8117000 | 53,45 |
| 100 | 111260002 | 8117001 | 19,36 |
| 125 | 111260005 | 8117002 | 22,51 |
| 160 | 111260006 | 8117003 | 28,30 |
| 200 | 111260007 | 8117004 | 35,61 |
| 250 | 111260008 | 8117005 | 43,24 |
| 315 | 111260009 | 8117006 | 57,09 |
| 400 | 111260011 | 8117007 | 108,61 |
| 500 | 111260012 | 8117008 | 133,76 |
| 630 | 111260013 | 8117009 | 166,10 |
| 800 | 111260014 | 8117010 | 212,33 |
| 1000 | 111260015 | 8117011 | 411,59 |
| 1250 | 111260016 | 8117012 | 559,95 |
| 1600 | 111260017 | 8117013 | 848,88 |

**Kierresaumakanava,
pituus 6 m
NTO-ZM**



| Tuotekoodi | LVI-koodi | Hinta €/m |
|------------|-----------|-----------|
| 111260020 | 8117014 | 53,45 |
| 111260021 | 8117015 | 19,36 |
| 111260022 | 8117016 | 22,51 |
| 111260023 | 8117017 | 28,30 |
| 111260024 | 8117018 | 35,61 |
| 111260025 | 8117019 | 43,24 |
| 111260026 | 8117020 | 57,09 |
| 111260027 | 8117021 | 108,61 |
| 111260028 | 8117022 | 133,76 |
| 111260029 | 8117023 | 166,10 |
| 111260030 | 8117024 | 212,33 |
| 111260031 | 8117025 | 411,59 |
| 111260032 | 8117026 | 559,95 |
| 111260033 | 8117027 | 848,88 |

**Käyrä 90°
NV-ZM**



| Koko Ød | Tuotekoodi | LVI-koodi | Hinta €/m |
|---------|------------|-----------|-----------|
| 100 | 111260040 | 8117028 | 36,35 |
| 125 | 111260041 | 8117029 | 38,03 |
| 160 | 111260042 | 8117030 | 41,36 |
| 200 | 111260043 | 8117031 | 45,26 |
| 250 | 111260044 | 8117032 | 61,99 |
| 315 | 111260045 | 8117033 | 79,48 |
| 400 | 111260046 | 8117034 | 143,71 |
| 500 | 111260047 | 8117035 | 181,31 |
| 630 | 111260048 | 8117036 | 280,62 |
| 800 | 111260049 | 8117037 | 483,71 |
| 1000 | 111260050 | 8117038 | 968,76 |
| 1250 | 111260051 | 8117039 | 1388,39 |
| 1600 | 111260052 | 8117040 | 2262,41 |

**Käyrä 60°
NV-ZM**



| Koko Ød | Tuotekoodi | LVI-koodi | Hinta €/kpl |
|---------|------------|-----------|-------------|
| 100 | 111260060 | 8117041 | 76,38 |
| 125 | 111260061 | 8117042 | 73,73 |
| 160 | 111260062 | 8117043 | 79,99 |
| 200 | 111260063 | 8117044 | 89,82 |
| 250 | 111260064 | 8117045 | 90,96 |
| 315 | 111260065 | 8117046 | 101,72 |
| 400 | 111260066 | 8117047 | 124,12 |
| 500 | 111260067 | 8117048 | 154,26 |
| 630 | 111260068 | 8117049 | 204,49 |
| 800 | 111260069 | 8117050 | 394,19 |
| 1000 | 111260070 | 8117051 | 750,79 |
| 1250 | 111260071 | 8117052 | 1041,46 |
| 1600 | 111260072 | 8117053 | 1780,93 |

**Käyrä 45°
NV-ZM**



| Tuotekoodi | LVI-koodi | Hinta €/kpl |
|------------|-----------|-------------|
| 111260080 | 8117054 | 25,88 |
| 111260081 | 8117055 | 27,16 |
| 111260082 | 8117056 | 35,87 |
| 111260083 | 8117057 | 37,58 |
| 111260084 | 8117058 | 50,68 |
| 111260085 | 8117059 | 62,36 |
| 111260086 | 8117060 | 114,74 |
| 111260087 | 8117061 | 140,28 |
| 111260088 | 8117062 | 185,38 |
| 111260089 | 8117063 | 352,88 |
| 111260090 | 8117064 | 666,92 |
| 111260091 | 8117065 | 912,65 |
| 111260092 | 8117066 | 1429,09 |

**Käyrä 30°
NV-ZM**



| Tuotekoodi | LVI-koodi | Hinta €/kpl |
|------------|-----------|-------------|
| 111260100 | 8117067 | 75,31 |
| 111260101 | 8117068 | 76,26 |
| 111260102 | 8117069 | 89,50 |
| 111260103 | 8117070 | 79,58 |
| 111260104 | 8117071 | 84,07 |
| 111260105 | 8117072 | 92,05 |
| 111260106 | 8117073 | 106,96 |
| 111260107 | 8117074 | 126,44 |
| 111260108 | 8117075 | 163,20 |
| 111260109 | 8117076 | 320,14 |
| 111260110 | 8117077 | 585,96 |
| 111260111 | 8117078 | 787,18 |
| 111260112 | 8117079 | 1083,86 |

**Käyrä 15°
NV-ZM**



| Koko Ød | Tuotekoodi | LVI-koodi | Hinta €/kpl |
|---------|------------|-----------|-------------|
| 100 | 111260120 | 8117080 | 70,80 |
| 125 | 111260121 | 8117081 | 72,24 |
| 160 | 111260122 | 8117082 | 72,24 |
| 200 | 111260123 | 8117083 | 90,44 |
| 250 | 111260124 | 8117084 | 83,21 |
| 315 | 111260125 | 8117085 | 89,69 |
| 400 | 111260126 | 8117086 | 99,50 |
| 500 | 111260127 | 8117087 | 116,21 |
| 630 | 111260128 | 8117088 | 144,66 |
| 800 | 111260129 | 8117089 | 290,08 |
| 1000 | 111260130 | 8117090 | 506,63 |
| 1250 | 111260131 | 8117091 | 663,13 |
| 1600 | 111260132 | 8117092 | 1087,67 |

**Käyrä, jyrkkä
NVK-ZM**



| Tuotekoodi | LVI-koodi | Hinta €/kpl |
|------------|-----------|-------------|
| 111261041 | 8118245 | 80,96 |
| 111261042 | 8118246 | 97,99 |
| 111261043 | 8118247 | 119,14 |
| 111261044 | 8118248 | 219,31 |
| 111261045 | 8118249 | 276,66 |
| 111261046 | 8118250 | 361,07 |
| 111261047 | 8118251 | 653,28 |
| 111261048 | 8118252 | 1257,56 |
| 111261049 | 8118253 | 1803,11 |

**Käyrä, jyrkkä
(kanava/osa)
NVKM-ZM**



| Tuotekoodi | LVI-koodi | Hinta €/kpl |
|------------|-----------|-------------|
| 111261051 | 8117511 | 86,33 |
| 111261052 | 8117512 | 104,48 |
| 111261053 | 8117513 | 127,18 |
| 111261054 | 8117514 | 234,97 |
| 111261055 | 8117515 | 296,51 |
| 111261056 | 8117516 | 388,46 |
| 111261057 | 8117517 | 705,18 |
| 111261058 | 8117518 | 1271,78 |
| 111261059 | 8117519 | 1823,95 |

Ilmanvaihtokanavajärjestelmät

Pyöreä kanavajärjestelmä, Magnelis (ZM310)

Sisäliitin NI-ZM



| Koko Ød | Tuotekoodi | LVI-koodi | Hinta €/kpl |
|---------|------------|-----------|-------------|
| 80 | 111260140 | 8117093 | 93,59 |
| 100 | 111260141 | 8117094 | 11,76 |
| 125 | 111260142 | 8117095 | 13,02 |
| 160 | 111260143 | 8117096 | 15,41 |
| 200 | 111260144 | 8117097 | 16,22 |
| 250 | 111260145 | 8117098 | 28,73 |
| 315 | 111260146 | 8117099 | 33,94 |
| 400 | 111260147 | 8117100 | 67,64 |
| 500 | 111260148 | 8117101 | 75,53 |
| 630 | 111260149 | 8117102 | 80,22 |
| 800 | 111260150 | 8117103 | 149,45 |
| 1000 | 111260151 | 8117104 | 179,34 |
| 1250 | 111260152 | 8117105 | 198,19 |
| 1600 | 111260153 | 8117106 | 397,80 |

Sisäliitin pitkä kanavalle NIL-ZM

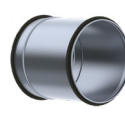

| Tuotekoodi | LVI-koodi | Hinta €/kpl |
|------------|-----------|-------------|
| 111260160 | 8117107 | 64,68 |
| 111260161 | 8117108 | 65,18 |
| 111260162 | 8117109 | 66,60 |
| 111260163 | 8117110 | 67,79 |
| 111260164 | 8117111 | 76,46 |
| 111260165 | 8117112 | 81,37 |
| 111260166 | 8117113 | 92,40 |
| 111260167 | 8117114 | 111,61 |
| 111260168 | 8117115 | 124,36 |
| 111260169 | 8117116 | 222,86 |
| 111260170 | 8117117 | 298,96 |
| 111260171 | 8117118 | 339,38 |
| 111260172 | 8118254 | 429,76 |

Pitkä sisä-ulkoliitin NILM-ZM

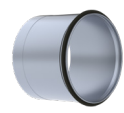

| Tuotekoodi | LVI-koodi | Hinta €/kpl |
|------------|-----------|-------------|
| 111260175 | 8117133 | 80,05 |
| 111260176 | 8117134 | 80,87 |
| 111260177 | 8117135 | 82,12 |
| 111260178 | 8117136 | 83,53 |
| 111260179 | 8117137 | 88,34 |
| 111260180 | 8117138 | 92,90 |
| 111260181 | 8117139 | 102,60 |

Ulkoliitin NM-ZM



| Koko Ød | Tuotekoodi | LVI-koodi | Hinta €/kpl |
|---------|------------|-----------|-------------|
| 80 | 111260185 | 8117119 | 58,68 |
| 100 | 111260186 | 8117120 | 5,51 |
| 125 | 111260187 | 8117121 | 5,88 |
| 160 | 111260188 | 8117122 | 6,24 |
| 200 | 111260189 | 8117123 | 6,70 |
| 250 | 111260190 | 8117124 | 14,36 |
| 315 | 111260191 | 8117125 | 17,48 |
| 400 | 111260192 | 8117126 | 47,52 |
| 500 | 111260193 | 8117127 | 52,66 |
| 630 | 111260194 | 8117128 | 56,88 |
| 800 | 111260195 | 8117129 | 99,36 |
| 1000 | 111260196 | 8117130 | 118,94 |
| 1250 | 111260197 | 8117131 | 132,48 |
| 1600 | 111260198 | 8117132 | 265,97 |

Lähtökaulus tasopinnalle, jyrkkä NSK-ZM



| Tuotekoodi | LVI-koodi | Hinta €/kpl |
|------------|-----------|-------------|
| 111260200 | 8117140 | 132,02 |
| 111260201 | 8117141 | 18,65 |
| 111260202 | 8117142 | 19,19 |
| 111260203 | 8117143 | 19,84 |
| 111260204 | 8117144 | 20,33 |
| 111260205 | 8117145 | 22,80 |
| 111260206 | 8117146 | 24,71 |
| 111260207 | 8117147 | 81,40 |
| 111260208 | 8117148 | 85,97 |
| 111260209 | 8117149 | 90,86 |
| 111260210 | 8117150 | 292,74 |
| 111260211 | 8117151 | 311,70 |
| 111260212 | 8117152 | 329,82 |
| 111260213 | 8117153 | 451,22 |

Lähtökaulus tasopinnalle (osalle) NSKM-ZM



| Tuotekoodi | LVI-koodi | Hinta €/kpl |
|------------|-----------|-------------|
| 111260220 | 8117154 | 91,93 |
| 111260221 | 8117155 | 46,08 |
| 111260222 | 8117156 | 46,80 |
| 111260223 | 8117157 | 47,52 |
| 111260224 | 8117158 | 48,25 |
| 111260225 | 8117159 | 49,81 |
| 111260226 | 8117160 | 50,77 |
| 111260227 | 8117161 | 55,58 |
| 111260228 | 8117162 | 57,49 |
| 111260229 | 8117163 | 60,86 |
| 111260230 | 8117164 | 135,02 |
| 111260231 | 8117165 | 151,22 |
| 111260232 | 8117166 | 167,08 |
| 111260233 | 8118255 | 217,85 |

Lähtökaulus pyöreälle NPSV-ZM



| Koko ØD-d | Tuotekoodi | LVI-koodi | Hinta €/kpl |
|-----------|------------|-----------|-------------|
| 400/400 | 111260356 | 8117376 | 126,44 |
| 500/400 | 111260360 | 8117377 | 130,51 |
| 500/500 | 111260361 | 8117378 | 147,56 |
| 630/400 | 111260364 | 8117379 | 133,58 |
| 630/500 | 111260365 | 8117380 | 158,44 |
| 630/630 | 111260366 | 8117381 | 192,82 |
| 800/400 | 111260369 | 8117382 | 196,76 |
| 800/500 | 111260370 | 8117383 | 209,54 |
| 800/630 | 111260371 | 8117384 | 250,66 |
| 800/800 | 111260372 | 8117385 | 410,46 |
| 1000/400 | 111260376 | 8117386 | 192,91 |
| 1000/500 | 111260377 | 8117387 | 212,51 |
| 1000/630 | 111260378 | 8117388 | 249,28 |
| 1000/800 | 111260379 | 8117389 | 415,57 |

| Koko ØD-d | Tuotekoodi | LVI-koodi | Hinta €/kpl |
|-----------|------------|-----------|-------------|
| 1000/1000 | 111260380 | 8117390 | 544,27 |
| 1250/400 | 111260381 | 8117391 | 198,90 |
| 1250/500 | 111260382 | 8117392 | 220,55 |
| 1250/630 | 111260383 | 8117393 | 253,33 |
| 1250/800 | 111260384 | 8117394 | 431,46 |
| 1250/1000 | 111260385 | 8117395 | 554,28 |
| 1250/1250 | 111260386 | 8117396 | 661,12 |
| 1600/400 | 111260387 | 8118309 | 186,52 |
| 1600/500 | 111260388 | 8118310 | 216,36 |
| 1600/630 | 111260389 | 8118311 | 1084,25 |
| 1600/800 | 111260390 | 8118312 | 616,27 |
| 1600/1000 | 111260391 | 8118313 | 853,52 |
| 1600/1250 | 111260392 | 8118314 | 2660,24 |
| 1600/1600 | 111260393 | 8118315 | 1386,24 |

Pyöreä kanavajärjestelmä, Magnelis (ZM310)

Lähtökaulus,
lyhyt kaulus
NPSK-ZM



| Koko ØD-d | Tuotekoodi | LVI-koodi | Hinta €/kpl |
|--------------|------------|-----------|----------------|
| 100/100 | 111260242 | 8117325 | 25,88 |
| 125/100 | 111260244 | 8117326 | 73,52 |
| 125/125 | 111260245 | 8117327 | 75,84 |
| 160/100 | 111260247 | 8117328 | 72,44 |
| 160/125 | 111260248 | 8117329 | 73,56 |
| 160/160 | 111260249 | 8117330 | 75,66 |
| 200/100 | 111260251 | 8117331 | 25,25 |
| 200/125 | 111260252 | 8117332 | 27,38 |
| 200/160 | 111260253 | 8117333 | 41,23 |
| 200/200 | 111260254 | 8117334 | 41,23 |
| 250/100 | 111260255 | 8117335 | 29,18 |
| 250/125 | 111260256 | 8117336 | 30,47 |
| 250/160 | 111260257 | 8117337 | 39,14 |
| 250/200 | 111260258 | 8117338 | 39,14 |
| 250/250 | 111260259 | 8117339 | 52,84 |
| 315/100 | 111260260 | 8117340 | 28,78 |
| 315/125 | 111260261 | 8117341 | 29,95 |
| 315/160 | 111260262 | 8117342 | 38,92 |
| 315/200 | 111260263 | 8117343 | 38,92 |
| 315/250 | 111260264 | 8117344 | 52,84 |
| 315/315 | 111260265 | 8117345 | 47,86 |
| 400/100 | 111260266 | 8117346 | 72,32 |
| 400/125 | 111260267 | 8117347 | 73,31 |
| 400/160 | 111260268 | 8117348 | 74,80 |
| 400/200 | 111260269 | 8117349 | 79,06 |
| 400/250 | 111260270 | 8117350 | 83,53 |
| 400/315 | 111260271 | 8117351 | 88,21 |
| 400/400 | 111260272 | 8118261 | 109,16 |
| 500/100 | 111260273 | 8117352 | 72,32 |
| 500/125 | 111260274 | 8117353 | 73,18 |
| 500/160 | 111260275 | 8117354 | 74,57 |
| 500/200 | 111260276 | 8117355 | 78,92 |
| 500/250 | 111260277 | 8117356 | 83,21 |
| 500/315 | 111260278 | 8117357 | 87,14 |
| 500/400 | 111260279 | 8118262 | 103,44 |
| 500/500 | 111260280 | 8118263 | 122,04 |
| 630/100 | 111260281 | 8117358 | 72,23 |
| 630/125 | 111260282 | 8117359 | 73,10 |
| 630/160 | 111260283 | 8117360 | 74,57 |
| 630/200 | 111260284 | 8117361 | 78,83 |
| 630/250 | 111260285 | 8117362 | 82,99 |
| 630/315 | 111260286 | 8117363 | 86,48 |

| Koko ØD-d | Tuotekoodi | LVI-koodi | Hinta €/kpl |
|--------------|------------|-----------|----------------|
| 630/400 | 111260287 | 8118264 | 101,14 |
| 630/500 | 111260288 | 8118265 | 117,36 |
| 630/630 | 111260289 | 8118266 | 141,10 |
| 800/160 | 111260290 | 8117364 | 128,78 |
| 800/200 | 111260291 | 8117365 | 132,64 |
| 800/250 | 111260292 | 8117366 | 137,21 |
| 800/315 | 111260293 | 8117367 | 140,74 |
| 800/400 | 111260294 | 8118267 | 153,89 |
| 800/500 | 111260295 | 8118268 | 156,68 |
| 800/630 | 111260296 | 8118269 | 171,60 |
| 800/800 | 111260297 | 8118270 | 355,72 |
| 1000/160 | 111260299 | 8117368 | 128,78 |
| 1000/200 | 111260300 | 8117369 | 132,85 |
| 1000/250 | 111260301 | 8117370 | 136,57 |
| 1000/315 | 111260302 | 8117371 | 140,28 |
| 1000/400 | 111260303 | 8118272 | 153,30 |
| 1000/500 | 111260304 | 8118273 | 155,18 |
| 1000/630 | 111260305 | 8118274 | 167,15 |
| 1000/800 | 111260306 | 8118275 | 301,43 |
| 1000/1000 | 111260298 | 8118271 | 430,20 |
| 1250/160 | 111260309 | 8117372 | 138,71 |
| 1250/200 | 111260310 | 8117373 | 132,95 |
| 1250/250 | 111260311 | 8117374 | 137,11 |
| 1250/315 | 111260312 | 8117375 | 140,28 |
| 1250/400 | 111260313 | 8118278 | 153,07 |
| 1250/500 | 111260314 | 8118279 | 153,70 |
| 1250/630 | 111260315 | 8118280 | 165,62 |
| 1250/800 | 111260316 | 8118281 | 295,45 |
| 1250/1000 | 111260307 | 8118276 | 361,10 |
| 1250/1250 | 111260308 | 8118277 | 493,92 |
| 1600/160 | 111260319 | 8118284 | 125,33 |
| 1600/200 | 111260321 | 8118286 | 131,32 |
| 1600/250 | 111260322 | 8118287 | 135,79 |
| 1600/315 | 111260323 | 8118288 | 140,27 |
| 1600/400 | 111260324 | 8118289 | 152,21 |
| 1600/500 | 111260325 | 8118290 | 161,16 |
| 1600/630 | 111260326 | 8118291 | 174,59 |
| 1600/800 | 111260327 | 8118292 | 304,38 |
| 1600/1000 | 111260317 | 8118282 | 359,60 |
| 1600/1250 | 111260318 | 8118283 | 434,23 |
| 1600/1600 | 111260320 | 8118285 | 726,71 |

Ilmanvaihtokanavajärjestelmät

Pyöreä kanavajärjestelmä, Magnelis (ZM310)

T-yhde NTK-ZM



| Koko Ød1-d2 | Tuotekoodi | LVI-koodi | Hinta €/kpl |
|-------------|------------|-----------|-------------|
| 100/100 | 111260402 | 8117397 | 97,81 |
| 125/100 | 111260404 | 8117398 | 147,60 |
| 125/125 | 111260405 | 8117399 | 150,38 |
| 160/100 | 111260407 | 8117401 | 148,34 |
| 160/125 | 111260408 | 8117402 | 101,65 |
| 160/160 | 111260409 | 8117403 | 153,37 |
| 200/100 | 111260411 | 8117405 | 101,80 |
| 200/125 | 111260412 | 8117406 | 104,40 |
| 200/160 | 111260413 | 8117407 | 106,82 |
| 200/200 | 111260414 | 8117408 | 114,25 |
| 250/100 | 111260415 | 8117409 | 117,73 |
| 250/125 | 111260416 | 8117410 | 119,65 |
| 250/160 | 111260417 | 8117411 | 122,99 |
| 250/200 | 111260418 | 8117412 | 129,74 |
| 250/250 | 111260419 | 8117413 | 143,89 |
| 315/100 | 111260420 | 8117414 | 126,72 |
| 315/125 | 111260421 | 8117415 | 128,76 |
| 315/160 | 111260422 | 8117416 | 132,96 |
| 315/200 | 111260423 | 8117417 | 140,28 |
| 315/250 | 111260424 | 8117418 | 147,49 |
| 315/315 | 111260425 | 8117419 | 157,09 |
| 400/100 | 111260426 | 8117420 | 191,53 |
| 400/125 | 111260427 | 8117421 | 194,06 |
| 400/160 | 111260428 | 8117422 | 200,06 |
| 400/200 | 111260429 | 8117423 | 209,06 |
| 400/250 | 111260430 | 8117424 | 217,10 |
| 400/315 | 111260431 | 8117425 | 225,40 |
| 500/100 | 111260432 | 8117426 | 211,24 |

| Koko Ød1-d2 | Tuotekoodi | LVI-koodi | Hinta €/kpl |
|-------------|------------|-----------|-------------|
| 500/125 | 111260433 | 8117427 | 213,88 |
| 500/160 | 111260434 | 8117428 | 220,94 |
| 500/200 | 111260435 | 8117429 | 231,17 |
| 500/250 | 111260436 | 8117430 | 239,90 |
| 500/315 | 111260437 | 8117431 | 248,30 |
| 630/100 | 111260438 | 8117432 | 240,22 |
| 630/125 | 111260439 | 8117433 | 245,69 |
| 630/160 | 111260440 | 8117434 | 265,99 |
| 630/200 | 111260441 | 8117435 | 277,40 |
| 630/250 | 111260442 | 8117436 | 291,17 |
| 630/315 | 111260443 | 8117437 | 300,97 |
| 800/160 | 111260444 | 8117438 | 396,94 |
| 800/200 | 111260445 | 8117439 | 408,58 |
| 800/250 | 111260446 | 8117440 | 441,19 |
| 800/315 | 111260447 | 8117441 | 456,71 |
| 1000/160 | 111260448 | 8117442 | 448,80 |
| 1000/200 | 111260449 | 8117443 | 465,16 |
| 1000/250 | 111260450 | 8117444 | 482,94 |
| 1000/315 | 111260451 | 8117445 | 503,63 |
| 1250/160 | 111260452 | 8117446 | 498,02 |
| 1250/200 | 111260453 | 8117447 | 518,08 |
| 1250/250 | 111260454 | 8117448 | 523,48 |
| 1250/315 | 111260455 | 8117449 | 547,66 |
| 1600/160 | 111260456 | 8118319 | 583,42 |
| 1600/200 | 111260457 | 8118320 | 608,82 |
| 1600/250 | 111260458 | 8118321 | 637,18 |
| 1600/315 | 111260459 | 8118322 | 668,51 |

T-yhde NTKV-ZM



| Koko Ød1-d2 | Tuotekoodi | LVI-koodi | Hinta €/kpl |
|-------------|------------|-----------|-------------|
| 400/400 | 111260470 | 8117450 | 310,73 |
| 500/400 | 111260471 | 8117451 | 329,87 |
| 500/500 | 111260472 | 8117452 | 357,32 |
| 630/400 | 111260473 | 8117453 | 459,22 |
| 630/500 | 111260474 | 8117454 | 496,48 |
| 630/630 | 111260475 | 8117455 | 550,24 |
| 800/400 | 111260476 | 8117456 | 754,34 |
| 800/500 | 111260477 | 8117457 | 785,36 |
| 800/630 | 111260478 | 8117458 | 832,06 |
| 800/800 | 111260479 | 8117459 | 1002,92 |
| 1000/400 | 111260481 | 8117460 | 921,02 |
| 1000/500 | 111260482 | 8117461 | 935,40 |
| 1000/630 | 111260483 | 8117462 | 1109,00 |
| 1000/800 | 111260484 | 8117463 | 1233,78 |

| Koko Ød1-d2 | Tuotekoodi | LVI-koodi | Hinta €/kpl |
|-------------|------------|-----------|-------------|
| 1000/1000 | 111260480 | 8117464 | 1749,50 |
| 1250/400 | 111260487 | 8117465 | 1236,14 |
| 1250/500 | 111260488 | 8117466 | 1340,40 |
| 1250/630 | 111260489 | 8117467 | 1511,34 |
| 1250/800 | 111260490 | 8117468 | 1569,66 |
| 1250/1000 | 111260485 | 8117469 | 1774,60 |
| 1250/1250 | 111260486 | 8117470 | 2472,52 |
| 1600/400 | 111260494 | 8118326 | 1159,42 |
| 1600/500 | 111260495 | 8118327 | 1202,69 |
| 1600/630 | 111260496 | 8118328 | 1371,31 |
| 1600/800 | 111260497 | 8118329 | 1644,38 |
| 1600/1000 | 111260491 | 8118323 | 1969,68 |
| 1600/1250 | 111260492 | 8118324 | 2112,91 |
| 1600/1600 | 111260493 | 8118325 | 2518,82 |

Pyöreä kanavajärjestelmä, Magnelis (ZM310)

Muunto keskeinen, osakoko NFCV-ZM



| Koko Ød1-d2 | Tuotekoodi | LVI-koodi | Hinta €/kpl |
|----------------|------------|-----------|----------------|
| 125/100 | 111260501 | 8117170 | 143,12 |
| 160/100 | 111260503 | 8117171 | 40,00 |
| 160/125 | 111260504 | 8117172 | 39,47 |
| 200/100 | 111260506 | 8117173 | 42,43 |
| 200/125 | 111260507 | 8117174 | 43,19 |
| 200/160 | 111260508 | 8117175 | 43,27 |
| 250/100 | 111260509 | 8117176 | 95,44 |
| 250/125 | 111260510 | 8117177 | 73,22 |
| 250/160 | 111260511 | 8117178 | 50,11 |
| 250/200 | 111260512 | 8117179 | 49,13 |
| 315/125 | 111260513 | 8117180 | 103,94 |
| 315/160 | 111260514 | 8117181 | 59,23 |
| 315/200 | 111260515 | 8117182 | 59,23 |
| 315/250 | 111260516 | 8117183 | 57,41 |
| 400/125 | 111260517 | 8118330 | 219,77 |
| 400/160 | 111260518 | 8117184 | 124,10 |
| 400/200 | 111260519 | 8117185 | 122,35 |
| 400/250 | 111260520 | 8117186 | 121,37 |
| 400/315 | 111260521 | 8117187 | 117,18 |
| 500/125 | 111260522 | 8118331 | 254,44 |
| 500/160 | 111260523 | 8118332 | 149,65 |
| 500/200 | 111260524 | 8117188 | 141,59 |
| 500/250 | 111260525 | 8117189 | 140,60 |
| 500/315 | 111260526 | 8117190 | 135,96 |
| 500/400 | 111260527 | 8117191 | 131,93 |
| 630/160 | 111260528 | 8118333 | 152,59 |
| 630/200 | 111260529 | 8118334 | 164,48 |
| 630/250 | 111260530 | 8117192 | 163,34 |
| 630/315 | 111260531 | 8117193 | 167,36 |
| 630/400 | 111260532 | 8117194 | 169,34 |
| 630/500 | 111260533 | 8117195 | 162,50 |
| 800/315 | 111260534 | 8118335 | 318,76 |
| 800/400 | 111260535 | 8117196 | 389,34 |
| 800/500 | 111260536 | 8117197 | 391,39 |
| 800/630 | 111260537 | 8117198 | 371,02 |
| 1000/315 | 111260538 | 8118336 | 651,61 |
| 1000/400 | 111260539 | 8117199 | 466,07 |
| 1000/500 | 111260540 | 8117200 | 473,06 |
| 1000/630 | 111260541 | 8117201 | 480,82 |
| 1000/800 | 111260542 | 8117202 | 565,84 |
| 1250/400 | 111260544 | 8118337 | 604,84 |
| 1250/500 | 111260545 | 8117203 | 610,85 |
| 1250/630 | 111260546 | 8117204 | 623,54 |
| 1250/800 | 111260547 | 8117205 | 719,28 |
| 1250/1000 | 111260543 | 8117206 | 664,84 |
| 1600/800 | 111260550 | 8118340 | 908,75 |
| 1600/1000 | 111260548 | 8118338 | 844,57 |
| 1600/1250 | 111260549 | 8118339 | 849,05 |

Muunto keskeinen, osakoko NFCVM- ZM



| Koko ØD-d2 | Tuotekoodi | LVI-koodi | Hinta €/kpl |
|---------------|------------|-----------|----------------|
| 125/100 | 111260561 | 8117210 | 138,43 |
| 160/100 | 111260563 | 8117211 | 36,42 |
| 160/125 | 111260564 | 8117212 | 36,48 |
| 200/100 | 111260566 | 8117213 | 37,75 |
| 200/125 | 111260567 | 8117214 | 39,32 |
| 200/160 | 111260568 | 8117215 | 39,32 |
| 250/100 | 111260569 | 8117216 | 89,66 |
| 250/125 | 111260570 | 8117217 | 63,72 |
| 250/160 | 111260571 | 8117218 | 45,61 |
| 250/200 | 111260572 | 8117219 | 44,17 |
| 315/125 | 111260573 | 8117220 | 97,50 |
| 315/160 | 111260574 | 8117221 | 53,47 |
| 315/200 | 111260575 | 8117222 | 52,12 |
| 315/250 | 111260576 | 8117223 | 51,90 |
| 400/160 | 111260577 | 8117224 | 114,83 |
| 400/200 | 111260578 | 8117225 | 113,26 |
| 400/250 | 111260579 | 8117226 | 111,79 |
| 400/315 | 111260580 | 8117227 | 107,89 |
| 500/200 | 111260581 | 8117228 | 130,96 |
| 500/250 | 111260582 | 8117229 | 130,54 |
| 500/315 | 111260583 | 8117230 | 125,81 |
| 500/400 | 111260584 | 8117231 | 121,45 |
| 630/250 | 111260585 | 8117232 | 151,62 |
| 630/315 | 111260586 | 8117233 | 154,85 |
| 630/400 | 111260587 | 8117234 | 157,76 |
| 630/500 | 111260588 | 8117235 | 151,01 |
| 800/400 | 111260589 | 8117236 | 314,59 |
| 800/500 | 111260590 | 8117237 | 317,72 |
| 800/630 | 111260591 | 8117238 | 297,30 |
| 1000/400 | 111260592 | 8117239 | 386,94 |
| 1000/500 | 111260593 | 8117240 | 393,24 |
| 1000/630 | 111260594 | 8117241 | 401,10 |
| 1000/800 | 111260595 | 8117242 | 484,45 |
| 1250/500 | 111260597 | 8117243 | 526,92 |
| 1250/630 | 111260598 | 8117244 | 539,51 |
| 1250/800 | 111260599 | 8117245 | 633,89 |
| 1250/1000 | 111260596 | 8117246 | 580,42 |
| 1600/800 | 111260602 | 8118343 | 1016,18 |
| 1600/1000 | 111260600 | 8118341 | 952,02 |
| 1600/1250 | 111260601 | 8118342 | 761,00 |

Ilmanvaihtokanavajärjestelmät

Pyöreä kanavajärjestelmä, Magnelis (ZM310)

Muunto keskeinen,
osakoko
NFB-ZM



| Koko Ød1-d2 | Tuotekoodi | LVI-koodi | Hinta €/kpl |
|----------------|------------|-----------|----------------|
| 125/100 | 111260611 | 8117250 | 157,09 |
| 160/100 | 111260613 | 8117251 | 95,26 |
| 160/125 | 111260614 | 8117252 | 95,26 |
| 200/100 | 111260616 | 8117253 | 98,62 |
| 200/125 | 111260617 | 8117254 | 98,62 |
| 200/160 | 111260618 | 8117255 | 98,62 |
| 250/100 | 111260619 | 8117256 | 103,62 |
| 250/125 | 111260620 | 8117257 | 103,62 |
| 250/160 | 111260621 | 8117258 | 103,62 |
| 250/200 | 111260622 | 8117259 | 101,94 |
| 315/125 | 111260623 | 8117260 | 111,96 |
| 315/160 | 111260624 | 8117261 | 111,96 |
| 315/200 | 111260625 | 8117262 | 110,30 |
| 315/250 | 111260626 | 8117263 | 110,30 |
| 400/125 | 111260627 | 8118344 | 141,28 |
| 400/160 | 111260628 | 8117264 | 133,70 |
| 400/200 | 111260629 | 8117265 | 130,36 |
| 400/250 | 111260630 | 8117266 | 128,71 |
| 400/315 | 111260631 | 8117267 | 125,33 |
| 500/125 | 111260632 | 8118345 | 143,50 |
| 500/160 | 111260633 | 8118346 | 153,73 |
| 500/200 | 111260634 | 8117268 | 150,41 |
| 500/250 | 111260635 | 8117269 | 148,73 |
| 500/315 | 111260636 | 8117270 | 143,72 |
| 500/400 | 111260637 | 8117271 | 148,73 |
| 630/160 | 111260638 | 8118347 | 170,41 |
| 630/200 | 111260639 | 8118348 | 164,87 |
| 630/250 | 111260640 | 8117272 | 177,17 |
| 630/315 | 111260641 | 8117273 | 175,50 |
| 630/400 | 111260642 | 8117274 | 175,50 |
| 630/500 | 111260643 | 8117275 | 168,82 |
| 800/315 | 111260644 | 8118349 | 421,14 |
| 800/400 | 111260645 | 8117276 | 407,78 |
| 800/500 | 111260646 | 8117277 | 406,13 |
| 800/630 | 111260647 | 8117278 | 384,38 |
| 1000/315 | 111260648 | 8118350 | 531,11 |
| 1000/400 | 111260649 | 8117279 | 501,37 |
| 1000/500 | 111260650 | 8117280 | 498,02 |
| 1000/630 | 111260651 | 8117281 | 494,69 |
| 1000/800 | 111260652 | 8117282 | 581,58 |
| 1250/400 | 111260654 | 8118351 | 621,23 |
| 1250/500 | 111260655 | 8118352 | 611,93 |
| 1250/630 | 111260656 | 8117283 | 643,42 |
| 1250/800 | 111260657 | 8117284 | 732,00 |
| 1250/1000 | 111260653 | 8117285 | 676,86 |
| 1600/800 | 111260660 | 8118355 | 866,21 |
| 1600/1000 | 111260658 | 8118353 | 794,17 |
| 1600/1250 | 111260659 | 8118354 | 937,94 |

Muunto keskeinen,
osakoko
NFBM- ZM



| Koko ØD-d2 | Tuotekoodi | LVI-koodi | Hinta €/kpl |
|---------------|------------|-----------|----------------|
| 125/100 | 111260671 | 8117288 | 95,26 |
| 160/100 | 111260673 | 8117290 | 101,94 |
| 160/125 | 111260674 | 8117291 | 98,62 |
| 200/100 | 111260676 | 8117292 | 113,64 |
| 200/125 | 111260677 | 8117293 | 110,30 |
| 200/160 | 111260678 | 8117294 | 103,62 |
| 250/100 | 111260679 | 8117295 | 132,02 |
| 250/125 | 111260680 | 8117296 | 128,71 |
| 250/160 | 111260681 | 8117297 | 120,31 |
| 250/200 | 111260682 | 8117298 | 111,96 |
| 315/125 | 111260683 | 8117299 | 158,76 |
| 315/160 | 111260684 | 8117300 | 152,08 |
| 315/200 | 111260685 | 8117301 | 140,39 |
| 315/250 | 111260686 | 8117302 | 128,71 |
| 400/160 | 111260687 | 8117303 | 223,96 |
| 400/200 | 111260688 | 8117304 | 208,92 |
| 400/250 | 111260689 | 8117305 | 190,51 |
| 400/315 | 111260690 | 8117306 | 162,08 |
| 500/200 | 111260691 | 8117307 | 294,13 |
| 500/250 | 111260692 | 8117308 | 272,42 |
| 500/315 | 111260693 | 8117309 | 238,99 |
| 500/400 | 111260694 | 8117310 | 207,24 |
| 630/250 | 111260695 | 8117311 | 357,65 |
| 630/315 | 111260696 | 8117312 | 350,96 |
| 630/400 | 111260697 | 8117313 | 330,90 |
| 630/500 | 111260698 | 8117314 | 274,06 |
| 800/400 | 111260699 | 8117315 | 558,17 |
| 800/500 | 111260700 | 8117316 | 549,83 |
| 800/630 | 111260701 | 8117317 | 518,08 |
| 1000/400 | 111260702 | 8117318 | 419,47 |
| 1000/500 | 111260703 | 8117319 | 1019,45 |
| 1000/630 | 111260704 | 8117320 | 977,68 |
| 1000/800 | 111260705 | 8117321 | 1128,37 |
| 1250/630 | 111260707 | 8117322 | 1654,52 |
| 1250/800 | 111260708 | 8117323 | 1560,94 |
| 1250/1000 | 111260706 | 8117324 | 1166,52 |
| 1600/800 | 111260711 | 8118358 | 3097,75 |
| 1600/1000 | 111260709 | 8118356 | 2647,13 |
| 1600/1250 | 111260710 | 8118357 | 2378,56 |

Pyöreä kanavajärjestelmä, Magnelis (ZM310)

Tulppa kanavalle NAL-ZM



| Koko Ød | Tuotekoodi | LVI-koodi | Hinta €/kpl |
|---------|------------|-----------|-------------|
| 100 | 111260721 | 8117484 | 26,75 |
| 125 | 111260722 | 8117485 | 27,16 |
| 160 | 111260723 | 8117486 | 28,31 |
| 200 | 111260724 | 8117487 | 29,88 |
| 250 | 111260725 | 8117488 | 33,04 |
| 315 | 111260726 | 8117489 | 44,65 |
| 400 | 111260727 | 8117490 | 91,22 |
| 500 | 111260728 | 8117491 | 99,11 |
| 630 | 111260729 | 8117492 | 108,53 |
| 800 | 111260730 | 8117493 | 306,72 |
| 1000 | 111260731 | 8117494 | 352,32 |
| 1250 | 111260732 | 8117495 | 397,96 |
| 1600 | 111260733 | 8118359 | 620,86 |

Tulppa osalle NALM-ZM



| Tuotekoodi | LVI-koodi | Hinta €/kpl |
|------------|-----------|-------------|
| 111260781 | 8117497 | 25,79 |
| 111260782 | 8117498 | 26,75 |
| 111260783 | 8117499 | 26,75 |
| 111260784 | 8117500 | 28,31 |
| 111260785 | 8117501 | 31,48 |
| 111260786 | 8117502 | 33,13 |
| 111260787 | 8117503 | 83,36 |
| 111260788 | 8117504 | 89,66 |
| 111260789 | 8117505 | 100,69 |
| 111260790 | 8117506 | 237,52 |
| 111260791 | 8117507 | 281,56 |
| 111260792 | 8117508 | 324,02 |
| 111260793 | 8118362 | 425,27 |

Tulppa-puhdistusluukku kanavalle NALH-ZM



| Tuotekoodi | LVI-koodi | Hinta €/kpl |
|------------|-----------|-------------|
| 111260741 | 8318737 | 62,92 |
| 111260742 | 8318738 | 62,92 |
| 111260743 | 8318739 | 64,49 |
| 111260744 | 8318740 | 64,79 |
| 111260745 | 8318741 | 69,22 |
| 111260746 | 8318742 | 80,22 |
| 111260747 | 8318743 | 294,13 |
| 111260748 | 8318744 | 302,02 |
| 111260749 | 8318745 | 313,02 |
| 111260750 | 8318746 | 350,77 |
| 111260751 | 8318747 | 396,37 |
| 111260752 | 8318748 | 441,97 |
| 111260753 | 8118361 | 546,90 |

Tulppa-puhdistusluukku osalle NALMH-ZM



| Koko Ød | Tuotekoodi | LVI-koodi | Hinta €/kpl |
|---------|------------|-----------|-------------|
| 100 | 111260801 | 8318749 | 61,84 |
| 125 | 111260802 | 8318750 | 61,84 |
| 160 | 111260803 | 8318751 | 61,84 |
| 200 | 111260804 | 8318752 | 63,49 |
| 250 | 111260805 | 8318753 | 63,49 |
| 315 | 111260806 | 8318754 | 73,54 |
| 400 | 111260807 | 8318755 | 125,33 |
| 500 | 111260808 | 8318756 | 128,71 |
| 630 | 111260809 | 8318757 | 137,04 |
| 800 | 111260810 | 8318758 | 218,94 |
| 1000 | 111260811 | 8318759 | 254,03 |
| 1250 | 111260812 | 8318760 | 292,46 |
| 1600 | 111260813 | 8118364 | 359,41 |

Tulppa-puhdistusluukku kanavalle, EI 60 NALHE-ZM



| Tuotekoodi | LVI-koodi | Hinta €/kpl |
|------------|-----------|-------------|
| 111260760 | 8318761 | 148,81 |
| 111260761 | 8318762 | 162,20 |
| 111260762 | 8318763 | 188,59 |
| 111260763 | 8318764 | 204,53 |
| 111260764 | 8318765 | 242,90 |
| 111260765 | 8318766 | 347,68 |
| 111260766 | 8318767 | 428,23 |
| 111260767 | 8318768 | 546,56 |
| 111260768 | 8318769 | 640,66 |
| 111260769 | 8318770 | 893,39 |
| 111260770 | 8318771 | 1011,18 |
| 111260771 | 8318772 | 1117,25 |

Tulppa-puhdistusluukku osalle, EI 60 NALMHE-ZM



| Tuotekoodi | LVI-koodi | Hinta €/kpl |
|------------|-----------|-------------|
| 111260820 | 8118365 | 81,50 |
| 111260821 | 8118366 | 83,60 |
| 111260822 | 8118367 | 90,22 |
| 111260823 | 8118368 | 106,81 |
| 111260824 | 8118369 | 101,58 |
| 111260825 | 8118370 | 125,74 |
| 111260826 | 8118371 | 147,28 |
| 111260827 | 8118372 | 217,80 |
| 111260828 | 8118373 | 255,65 |
| 111260829 | 8118374 | 451,97 |
| 111260830 | 8118375 | 602,66 |
| 111260831 | 8118376 | 768,28 |

Ilmanotto suojaverkolla (suora) NG-ZM



| Koko Ød | Tuotekoodi | LVI-koodi | Hinta €/kpl |
|---------|------------|-----------|-------------|
| 100 | 111260871 | 8118405 | 94,02 |
| 125 | 111260872 | 8118406 | 97,00 |
| 160 | 111260873 | 8118407 | 98,50 |
| 200 | 111260874 | 8118408 | 104,56 |
| 250 | 111260875 | 8118409 | 119,74 |
| 315 | 111260876 | 8118410 | 125,99 |
| 400 | 111260877 | 8118411 | 225,31 |
| 500 | 111260878 | 8118412 | 235,78 |
| 630 | 111260879 | 8118413 | 253,68 |
| 800 | 111260880 | 8118414 | 287,98 |
| 1000 | 111260881 | 8118415 | 332,76 |
| 1250 | 111260882 | 8118416 | 387,98 |
| 1600 | 111260883 | 8118417 | 532,70 |

Imukartio suojaverkolla NK-ZM

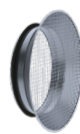

| Tuotekoodi | LVI-koodi | Hinta €/kpl |
|------------|-----------|-------------|
| 111260891 | 8117471 | 111,96 |
| 111260892 | 8117472 | 115,31 |
| 111260893 | 8117473 | 120,31 |
| 111260894 | 8117474 | 127,02 |
| 111260895 | 8117475 | 137,04 |
| 111260896 | 8117476 | 145,39 |
| 111260897 | 8117477 | 272,42 |
| 111260898 | 8117478 | 287,45 |
| 111260899 | 8117479 | 310,86 |
| 111260900 | 8117480 | 355,98 |
| 111260901 | 8117481 | 434,53 |
| 111260902 | 8117482 | 514,74 |

Ulostulo viisteinen, verkko NP-ZM

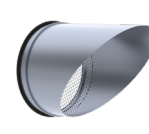

| Tuotekoodi | LVI-koodi | Hinta €/kpl |
|------------|-----------|-------------|
| 111260911 | 8118420 | 237,79 |
| 111260912 | 8118421 | 239,57 |
| 111260913 | 8118422 | 243,11 |
| 111260914 | 8118423 | 247,16 |
| 111260915 | 8118424 | 268,67 |
| 111260916 | 8118425 | 278,57 |
| 111260917 | 8118426 | 306,30 |
| 111260918 | 8118427 | 341,11 |
| 111260919 | 8118428 | 398,99 |
| 111260920 | 8118429 | 501,17 |
| 111260921 | 8118430 | 699,58 |
| 111260922 | 8118431 | 898,75 |
| 111260923 | 8118432 | 1431,05 |

12. Pyöreä kanavajärjestelmä, haponkestävä

**Kierresaumakanava,
pituus 3 m
NTO-H**



| Koko ØD | Tuotekoodi | LVI-koodi | Hinta €/m |
|---------|-------------|-----------|-----------|
| 100 | H10101013O | 8103798 | 99,15 |
| 125 | H10101123O | 8103799 | 120,53 |
| 160 | H10101163O | 8103800 | 143,88 |
| 200 | H10101203O | 8103801 | 186,65 |
| 250 | H10101253O | 8103802 | 219,70 |
| 315 | H10101313O | 8103804 | 288,90 |
| 400 | H10101403O | 8103806 | 482,18 |
| 500 | H10101503O | 8103807 | 593,01 |
| 630 | H10101633O | 8103808 | 725,20 |
| 800 | H10101803O | 8103809 | 915,75 |
| 1000 | H10101100O | 8103810 | 1254,05 |
| 1250 | H101012503O | 8103811 | 1532,06 |

**Kierresaumakanava,
pituus 6 m
NTO-H**



| Koko ØD | Tuotekoodi | LVI-koodi | Hinta €/m |
|---------|-------------|-----------|-----------|
| 100 | H10101016O | 8103848 | 99,15 |
| 125 | H10101126O | 8103849 | 120,53 |
| 160 | H10101166O | 8103850 | 143,88 |
| 200 | H10101206O | 8103851 | 186,65 |
| 250 | H10101256O | 8103852 | 219,70 |
| 315 | H10101316O | 8103854 | 288,90 |
| 400 | H10101406O | 8103856 | 482,18 |
| 500 | H10101506O | 8103857 | 593,01 |
| 630 | H10101636O | 8103858 | 725,20 |
| 800 | H10101806O | 8103859 | 915,75 |
| 1000 | H10101106O | 8103860 | 1254,05 |
| 1250 | H101012506O | 8103861 | 1532,06 |

**Sisäliitin
NI-H**



| Koko Ød | Tuotekoodi | LVI-koodi | Hinta €/m |
|---------|------------|-----------|-----------|
| 100 | H10203010 | 8114090 | 59,66 |
| 125 | H10203120 | 8114091 | 65,23 |
| 160 | H10203160 | 8114092 | 68,25 |
| 200 | H10203200 | 8114093 | 73,98 |
| 250 | H10203250 | 8114094 | 79,87 |
| 315 | H10203310 | 8114095 | 85,58 |
| 400 | H10203400 | 8114096 | 130,48 |
| 500 | H10203500 | 8114097 | 153,70 |
| 630 | H10203630 | 8114098 | 240,73 |
| 800 | H10203800 | 8114099 | 415,92 |
| 1000 | H10203100 | 8114100 | 585,38 |
| 1250 | H10203125 | 8114101 | 809,88 |

**Käyrä 90°
NV-H**



| Koko Ød | Tuotekoodi | LVI-koodi | Hinta €/kpl |
|---------|-------------|-----------|-------------|
| 100 | H10202019 | 8114001 | 139,23 |
| 125 | H10202129 | 8114002 | 159,59 |
| 160 | H10202169 | 8114003 | 168,34 |
| 200 | H10202209 | 8114004 | 229,92 |
| 250 | H10202259 | 8114005 | 264,60 |
| 315 | H10202319 | 8114006 | 348,13 |
| 400 | H10202409 | 8114007 | 469,53 |
| 500 | H10202509 | 8114008 | 609,88 |
| 630 | H10202639 | 8114009 | 1047,10 |
| 800 | H10202809 | 8114010 | 1898,35 |
| 1000 | H10202109 | 8114011 | 3431,70 |
| 1250 | H10202125-9 | 8114012 | 5013,59 |

**Käyrä 45°
NV-H**



| Tuotekoodi | LVI-koodi | Hinta €/kpl |
|-------------|-----------|-------------|
| H10202014 | 8114016 | 92,37 |
| H10202124 | 8114017 | 106,31 |
| H10202164 | 8114018 | 125,81 |
| H10202204 | 8114019 | 151,90 |
| H10202254 | 8114020 | 178,69 |
| H10202314 | 8114021 | 216,88 |
| H10202404 | 8114022 | 285,35 |
| H10202504 | 8114023 | 402,89 |
| H10202634 | 8114024 | 532,29 |
| H10202804 | 8114025 | 1094,33 |
| H10202104 | 8114026 | 2078,18 |
| H10202125-4 | 8114027 | 3021,72 |

**Ulkoliitin
NM-H**



| Tuotekoodi | LVI-koodi | Hinta €/kpl |
|-------------|-----------|-------------|
| H10204010 | 8114105 | 29,01 |
| H10204120 | 8114106 | 32,65 |
| H10204160 | 8114107 | 36,27 |
| H10204200 | 8114108 | 42,81 |
| H10204250 | 8114109 | 49,66 |
| H10204310 | 8114110 | 63,78 |
| H10204400 | 8114111 | 103,11 |
| H10204500 | 8114112 | 128,39 |
| H10204630 | 8114113 | 148,93 |
| H10204800 | 8114114 | 255,24 |
| H10204100-0 | 8114115 | 379,65 |
| H10204125 | 8114116 | 455,01 |

**Lähtökaulus
tasopinnalle, jyrkkä
NSK-H**



| Koko Ød | Tuotekoodi | LVI-koodi | Hinta €/kpl |
|---------|------------|-----------|-------------|
| 100 | H10205100 | 8114121 | 43,60 |
| 125 | H10205125 | 8114122 | 46,46 |
| 160 | H10205160 | 8114123 | 56,66 |
| 200 | H10205200 | 8114124 | 62,53 |
| 250 | H10205250 | 8114125 | 68,25 |
| 315 | H10205310 | 8114126 | 77,02 |
| 400 | H10205400 | 8114127 | 111,10 |
| 500 | H10205500 | 8114128 | 121,89 |
| 630 | H1020630 | 8114129 | 174,23 |
| 800 | H10205800 | 8114130 | 499,49 |
| 1000 | H102051000 | 8114131 | 627,77 |
| 1250 | H102051250 | 8114132 | 698,74 |

**Tulppa
kanavalle
NAL-H**



| Tuotekoodi | LVI-koodi | Hinta €/kpl |
|------------|-----------|-------------|
| H10208010 | 8114136 | 95,82 |
| H10208120 | 8114137 | 97,64 |
| H10208160 | 8114138 | 99,59 |
| H10208200 | 8114139 | 113,30 |
| H10208250 | 8114140 | 123,95 |
| H10208310 | 8114141 | 146,07 |
| H10208400 | 8114142 | 196,03 |
| H10208500 | 8114143 | 243,59 |
| H10208630 | 8114144 | 317,43 |
| H10208800 | 8114145 | 706,01 |
| H10208100 | 8114146 | 1088,85 |
| H10208150 | 8114147 | 1409,61 |

**Tulppa osalle
NALM-H**



| Tuotekoodi | LVI-koodi | Hinta €/kpl |
|-------------|-----------|-------------|
| H10208010-1 | 8114151 | 92,64 |
| H10208120-1 | 8114152 | 94,52 |
| H10208160-0 | 8114153 | 96,42 |
| H10208200-1 | 8114154 | 101,50 |
| H10208250-1 | 8114155 | 112,18 |
| H10208310-1 | 8114156 | 123,79 |
| H10208400-1 | 8114157 | 252,32 |
| H10208500-1 | 8114158 | 296,70 |
| H10208630-1 | 8114159 | 354,63 |
| H10208800-1 | 8114160 | 575,08 |
| H10201000-1 | 8114161 | 939,40 |
| H10201000-2 | 8114162 | 1164,70 |

Pyöreä kanavajärjestelmä, haponkestävä

Muunto keskeinen, osakoko NFCV-H



| Koko Ød1-d2 | Tuotekoodi | LVI-koodi | Hinta €/kpl |
|----------------|-------------|-----------|----------------|
| 125/100 | H10209121-0 | 8114702 | 123,31 |
| 160/100 | H10209160-1 | 8114704 | 150,31 |
| 160/125 | H10209161-2 | 8114705 | 150,31 |
| 200/100 | H10209201-0 | 8114707 | 180,00 |
| 200/125 | H10209201-2 | 8114708 | 180,00 |
| 200/160 | H10209200-2 | 8114709 | 180,00 |
| 250/100 | H10209251-0 | 8114711 | 202,02 |
| 250/125 | H10209252-1 | 8114712 | 202,02 |
| 250/160 | H10209251-6 | 8114713 | 202,02 |
| 250/200 | H10209252-0 | 8114714 | 202,02 |
| 315/100 | H10209311-0 | 8114716 | 227,73 |
| 315/125 | H10209311-2 | 8114717 | 227,73 |
| 315/160 | H10209311-6 | 8114718 | 227,73 |
| 315/200 | H10209312-0 | 8114719 | 227,73 |
| 315/250 | H10209312-5 | 8114720 | 227,73 |
| 400/100 | H10209401-0 | 8114722 | 283,29 |
| 400/125 | H10209401-2 | 8114723 | 283,29 |
| 400/160 | H10209401-6 | 8114724 | 283,29 |
| 400/200 | H10209402-0 | 8114725 | 283,29 |
| 400/250 | H10209402-5 | 8114726 | 283,29 |
| 400/315 | H10209403-1 | 8114727 | 283,29 |
| 500/100 | H10209501-0 | 8114729 | 348,06 |
| 500/125 | H10209501-2 | 8114730 | 348,06 |
| 500/160 | H10209501-6 | 8114731 | 348,06 |
| 500/200 | H10209502-0 | 8114732 | 348,06 |
| 500/250 | H10209502-5 | 8114733 | 348,06 |
| 500/315 | H10209503-1 | 8114734 | 348,06 |
| 500/400 | H10209504-0 | 8114735 | 348,06 |
| 630/100 | H10209631-0 | 8114737 | 546,11 |
| 630/125 | H10209631-2 | 8114738 | 546,11 |
| 630/160 | H10209631-6 | 8114739 | 546,11 |
| 630/200 | H10209632-0 | 8114740 | 546,11 |
| 630/250 | H10209632-5 | 8114741 | 546,11 |
| 630/315 | H10209633-1 | 8114742 | 546,11 |
| 630/400 | H10209634-0 | 8114743 | 546,11 |
| 630/500 | H10209635-0 | 8114744 | 546,11 |
| 800/400 | H102098040 | 8114752 | 826,22 |
| 800/500 | H10209805-0 | 8114753 | 807,06 |
| 800/630 | H10209806-0 | 8114754 | 807,06 |
| 1000/400 | 111023079 | 8114762 | 1267,61 |
| 1000/500 | H10209100-5 | 8114763 | 1267,61 |
| 1000/630 | H10209106-0 | 8114764 | 1267,61 |
| 1000/800 | H10209108-0 | 8114765 | 1267,61 |
| 1250/500 | 111023085 | 8114774 | 1773,79 |
| 1250/630 | 111023086 | 8114775 | 2327,31 |
| 1250/800 | 111023087 | 8114776 | 2077,97 |
| 1250/1000 | H102121000 | 8114777 | 2347,89 |

Muunto epäkeskeinen, osakoko NFB- H



| Koko Ød1-d2 | Tuotekoodi | LVI-koodi | Hinta €/kpl |
|----------------|--------------|-----------|----------------|
| 125/100 | 111025002 | 8114202 | 167,87 |
| 160/100 | 111025004 | 8114204 | 174,34 |
| 160/125 | H10209161-3 | 8114205 | 152,74 |
| 200/100 | H10209200-1 | 8114207 | 169,30 |
| 200/125 | 111025008 | 8114208 | 151,17 |
| 200/160 | H10209201-6 | 8114209 | 152,86 |
| 250/100 | 111025010 | 8114211 | 177,72 |
| 250/125 | 111025011 | 8114212 | 204,61 |
| 250/160 | 111025012 | 8114213 | 182,68 |
| 250/200 | 10209252-2 | 8114214 | 202,02 |
| 315/100 | 1020931100-2 | 8114216 | 203,75 |
| 315/125 | 1020931125-2 | 8114217 | 206,13 |
| 315/160 | 1020931160-2 | 8114218 | 227,73 |
| 315/200 | 1020931200-2 | 8114219 | 255,06 |
| 315/250 | 1020931250-2 | 8114220 | 232,31 |
| 400/125 | 1020940125 | 8114223 | 351,39 |
| 400/160 | 10209504-4 | 8114224 | 441,63 |
| 400/200 | 10209402-1 | 8114225 | 426,06 |
| 400/250 | 10209415-1 | 8114226 | 410,56 |
| 400/315 | 10209403-2 | 8114227 | 381,66 |
| 500/125 | 1020950125 | 8114230 | 369,50 |
| 500/160 | 1020950160 | 8114231 | 439,08 |
| 500/200 | 1020950200 | 8114232 | 529,08 |
| 500/250 | 10209504-3 | 8114233 | 509,99 |
| 500/315 | 1020950315 | 8114234 | 474,70 |
| 500/400 | 10209504-2 | 8114235 | 579,39 |
| 630/160 | 1020963160 | 8114239 | 457,08 |
| 630/200 | 1020963200 | 8114240 | 441,54 |
| 630/250 | 1020963250 | 8114241 | 623,00 |
| 630/315 | 1020963315 | 8114242 | 617,33 |
| 630/400 | 1020963400 | 8114243 | 728,17 |
| 630/500 | 10209635-2 | 8114244 | 668,04 |
| 800/315 | 1020980315 | 8114251 | 952,74 |
| 800/400 | 1020980400 | 8114252 | 1047,78 |
| 800/500 | 1020980500 | 8114253 | 1017,19 |
| 800/630 | 10209806-4 | 8114254 | 975,49 |
| 1000/400 | 111025094 | 8114262 | 1419,85 |
| 1000/500 | 1020910500 | 8114263 | 1514,80 |
| 1000/630 | 1020910630 | 8114264 | 1478,31 |
| 1000/800 | 10209108-1 | 8114265 | 1596,83 |
| 1250/500 | H10209125-1 | 8114274 | 2254,32 |
| 1250/630 | 1020912630 | 8114275 | 2230,52 |
| 1250/800 | 1020912800 | 8114276 | 2077,97 |
| 1250/1000 | 1020912100 | 8114277 | 1961,89 |

Ilmanvaihtokanavajärjestelmät

Pyöreä kanavajärjestelmä, haponkestävä

Lähtökaulus,
lyhyt kaulus
NPSK-H



| Koko ØD-d | Tuotekoodi | LVI-koodi | Hinta €/kpl |
|-----------|-------------|-----------|-------------|
| 100/100 | H10206101-0 | 8114302 | 121,56 |
| 125/100 | H10206101-2 | 8114303 | 135,71 |
| 125/125 | H10206101-3 | 8114304 | 138,43 |
| 160/100 | H10206161-4 | 8114305 | 175,96 |
| 160/125 | H10206161-2 | 8114306 | 179,47 |
| 160/160 | H10206160-0 | 8114307 | 185,37 |
| 200/100 | H10206201-0 | 8114905 | 197,16 |
| 200/125 | H10206201-2 | 8118960 | 203,02 |
| 200/160 | H10206201-6 | 8114309 | 220,86 |
| 200/200 | H10206202-0 | 8114310 | 226,72 |
| 250/100 | H10206251-0 | 8114906 | 237,23 |
| 250/125 | H10206251-2 | 8114907 | 249,16 |
| 250/160 | H10206251-6 | 8114311 | 259,67 |
| 250/200 | H10206252-0 | 8114312 | 265,70 |
| 250/250 | H10206251-5 | 8114313 | 379,48 |
| 315/100 | H10206311-0 | 8114908 | 300,79 |
| 315/125 | H10206311-2 | 8114909 | 306,92 |
| 315/160 | H10206311-6 | 8114314 | 313,08 |
| 315/200 | H10206312-0 | 8114315 | 320,42 |
| 315/250 | H10206312-5 | 8114316 | 326,98 |
| 315/315 | H10206313-1 | 8114317 | 333,51 |
| 400/100 | H10206401-0 | 8114910 | 289,25 |
| 400/125 | H10206401-2 | 8114911 | 295,15 |
| 400/160 | H10206401-6 | 8114912 | 312,32 |
| 400/200 | H10206402-0 | 8114318 | 318,69 |
| 400/250 | H10206402-5 | 8114319 | 352,88 |
| 400/315 | H10206403-1 | 8114320 | 360,07 |

| Koko ØD-d | Tuotekoodi | LVI-koodi | Hinta €/kpl |
|-----------|-------------|-----------|-------------|
| 400/400 | H10206404-K | 8114963 | 413,21 |
| 500/100 | H10206501-0 | 8114913 | 358,64 |
| 500/125 | H10206501-2 | 8114914 | 365,95 |
| 500/160 | H10206501-6 | 8114915 | 460,48 |
| 500/200 | H10206502-0 | 8114916 | 520,65 |
| 500/250 | H10206502-5 | 8114968 | 531,28 |
| 500/315 | H10206503-1 | 8114964 | 566,94 |
| 500/400 | H10206504-K | 8114965 | 578,53 |
| 630/100 | H10206631-0 | 8114918 | 462,79 |
| 630/125 | H10206631-2 | 8114919 | 472,24 |
| 630/160 | H10206631-6 | 8114920 | 543,73 |
| 630/200 | H10206632-0 | 8114921 | 554,84 |
| 630/250 | H10206632-5 | 8114922 | 565,92 |
| 630/315 | H10206633-1 | 8114966 | 653,65 |
| 630/400 | H10206604-1 | 8114967 | 666,98 |
| 800/160 | H10206802-0 | 8114925 | 590,04 |
| 800/200 | H10206803-2 | 8114926 | 602,08 |
| 800/250 | H10206803-4 | 8114927 | 699,97 |
| 800/315 | H10206803-5 | 8114928 | 714,25 |
| 800/400 | 111027092 | 8114929 | 885,29 |
| 1000/160 | H10206104-1 | 8114933 | 726,02 |
| 1000/200 | 111027097 | 8114934 | 689,08 |
| 1000/250 | 111027098 | 8114935 | 865,43 |
| 1000/315 | 111027099 | 8114936 | 950,36 |
| 1250/250 | 111027107 | 8114944 | 885,45 |
| 1250/315 | 111027108 | 8114945 | 1003,51 |

Lähtökaulus pyöreälle
NPSV-H



| Koko ØD-d | Tuotekoodi | LVI-koodi | Hinta €/kpl |
|-----------|-------------|-----------|-------------|
| 400/400 | H10206404-0 | 8114321 | 591,58 |
| 500/400 | H10206504-0 | 8114324 | 649,32 |
| 500/500 | H10206505-0 | 8114325 | 714,25 |
| 630/400 | H10206634-0 | 8114327 | 885,45 |
| 630/500 | H10206635-0 | 8114328 | 920,94 |
| 630/630 | H10206636-3 | 8114329 | 956,25 |
| 800/400 | H10206804-2 | 8114330 | 1121,57 |
| 800/500 | H10206806-5 | 8114331 | 1652,84 |
| 800/630 | H10206806-6 | 8114332 | 1770,90 |
| 800/800 | H10206806-7 | 8114333 | 2108,24 |
| 1000/400 | H10206100-4 | 8114359 | 2109,30 |
| 1000/500 | H10206100-5 | 8114334 | 1357,69 |
| 1000/630 | H10206100-6 | 8114335 | 1416,72 |
| 1000/800 | H10206100-8 | 8114336 | 1534,78 |
| 1000/1000 | H10206100-1 | 8114337 | 2556,98 |
| 1250/400 | H10206168-5 | 8114361 | 1239,63 |
| 1250/500 | 111028067 | 8114362 | 1298,66 |
| 1250/630 | H10206156-3 | 8114338 | 1523,01 |
| 1250/800 | 111028069 | 8114339 | 1611,46 |
| 1250/1000 | 111028070 | 8114340 | 3107,63 |
| 1250/1250 | 111028071 | 8114341 | 4041,17 |

T-yhde
NTKV-H



| Koko Ød1-d2 | Tuotekoodi | LVI-koodi | Hinta €/kpl |
|-------------|-------------|-----------|-------------|
| 400/400 | H10207401-4 | 8114445 | 690,66 |
| 500/400 | H10207501-4 | 8114453 | 838,19 |
| 500/500 | H10207500-5 | 8114454 | 1025,39 |
| 630/400 | H10207630-4 | 8114462 | 1399,94 |
| 630/500 | H10207630-5 | 8114463 | 1428,48 |
| 630/630 | H10207630-6 | 8114464 | 1457,06 |
| 800/400 | H10207802-3 | 8114472 | 1631,33 |
| 800/500 | H10207802-5 | 8114473 | 1819,60 |
| 800/630 | H10207802-6 | 8114474 | 2013,66 |
| 800/800 | H10207802-8 | 8114475 | 2291,61 |
| 1000/500 | H10207508-7 | 8114484 | 2349,42 |
| 1000/630 | H10207508-8 | 8114485 | 2774,97 |
| 1000/800 | H102100080 | 8114486 | 3087,28 |
| 1000/1000 | H10207100-1 | 8114487 | 4377,67 |
| 1250/400 | H10207509-8 | 8114495 | 4223,01 |
| 1250/500 | H10207509-5 | 8114496 | 4309,18 |
| 1250/630 | H10207510 | 8114497 | 4512,27 |
| 1250/800 | H102125080 | 8114498 | 4604,35 |
| 1250/1000 | H1020101250 | 8114499 | 4801,51 |
| 1250/1250 | H1020101251 | 8114500 | 6691,83 |

Pyöreä kanavajärjestelmä, haponkestävä

T-yhde NTK-H



| Koko Ød1-d2 | Tuotekoodi | LVI-koodi | Hinta €/kpl |
|-------------|-------------|-----------|-------------|
| 100/100 | H10207101-1 | 8114412 | 252,89 |
| 125/100 | H10207121-1 | 8114414 | 353,27 |
| 125/125 | H10207121-2 | 8114415 | 373,75 |
| 160/100 | H10207160-1 | 8114417 | 357,94 |
| 160/125 | H10207160-2 | 8114418 | 282,83 |
| 160/160 | H10207160-6 | 8114419 | 396,75 |
| 200/100 | H10207201-1 | 8114421 | 303,13 |
| 200/125 | H10207201-2 | 8114422 | 309,33 |
| 200/160 | H10207201-6 | 8114423 | 315,51 |
| 200/200 | H10207200-2 | 8114424 | 336,54 |
| 250/100 | H10207250-1 | 8114426 | 368,43 |
| 250/125 | H10207250-2 | 8114427 | 376,11 |
| 250/160 | H10207250-6 | 8114428 | 383,79 |
| 250/200 | H10207251-2 | 8114429 | 391,47 |
| 250/250 | H10207251-5 | 8114430 | 399,13 |
| 315/100 | H10207310-1 | 8114432 | 364,41 |
| 315/125 | H10207310-2 | 8114433 | 371,84 |
| 315/160 | H10207310-6 | 8114434 | 421,58 |
| 315/200 | H10207311-2 | 8114435 | 430,36 |
| 315/250 | H10207311-5 | 8114436 | 439,15 |
| 315/315 | H10207315-1 | 8114437 | 447,94 |
| 400/100 | H10207400-1 | 8114439 | 520,65 |
| 400/125 | H10207400-2 | 8114440 | 531,28 |
| 400/160 | H10207400-6 | 8114441 | 561,20 |
| 400/200 | H10207401-2 | 8114442 | 572,64 |

| Koko Ød1-d2 | Tuotekoodi | LVI-koodi | Hinta €/kpl |
|-------------|-------------|-----------|-------------|
| 400/250 | H10207401-5 | 8114443 | 584,11 |
| 400/315 | H10207401-3 | 8114444 | 625,32 |
| 500/100 | H10207500-1 | 8114447 | 752,03 |
| 500/125 | H10207500-2 | 8114448 | 767,38 |
| 500/160 | H10207500-6 | 8114449 | 786,81 |
| 500/200 | H10207501-2 | 8114450 | 802,88 |
| 500/250 | H10207501-5 | 8114451 | 818,93 |
| 500/315 | H10207501-3 | 8114452 | 838,19 |
| 630/100 | 111029073 | 8114456 | 983,45 |
| 630/125 | 111029074 | 8114457 | 1003,51 |
| 630/160 | H10207160-3 | 8114458 | 1099,16 |
| 630/200 | H10207160-4 | 8114459 | 1121,57 |
| 630/250 | H10207630-2 | 8114460 | 1144,01 |
| 630/315 | H10207630-3 | 8114461 | 1104,36 |
| 800/160 | H10207160-5 | 8114468 | 1214,81 |
| 800/200 | H10207800-2 | 8114469 | 1239,63 |
| 800/250 | H10207802-2 | 8114470 | 1376,85 |
| 800/315 | H10207160-7 | 8114471 | 1404,94 |
| 1000/160 | H10207160-8 | 8114479 | 2024,74 |
| 1000/200 | H10207160-9 | 8114480 | 2066,04 |
| 1000/250 | H10207508-3 | 8114481 | 2117,36 |
| 1000/315 | H10207508-2 | 8114482 | 2160,57 |
| 1250/250 | H10207509-6 | 8114493 | 3933,77 |
| 1250/315 | H10207509-7 | 8114494 | 4014,03 |

Tulppa-puhdistusluukku kanavalle NALH-H



| Koko Ød | Tuotekoodi | LVI-koodi | Hinta €/kpl |
|---------|--------------|-----------|-------------|
| 100 | H10208100-0 | 8318792 | 72,55 |
| 125 | H102081250-0 | 8318793 | 75,57 |
| 160 | H102081600-0 | 8318794 | 79,36 |
| 200 | H10208200-0 | 8318795 | 81,48 |
| 250 | H10208250-0 | 8318796 | 99,95 |
| 315 | H10208315-0 | 8318797 | 126,96 |
| 400 | H10208400-0 | 8318798 | 183,47 |
| 500 | H10208500-0 | 8318799 | 212,15 |
| 630 | H10208630-0 | 8318800 | 254,98 |
| 800 | H10208800-0 | 8318801 | 536,46 |
| 1000 | 111032011 | 8318802 | 800,64 |
| 1250 | 111032012 | 8318803 | 1021,79 |

Tulppa-puhdistusluukku osalle NALMH-H



| Koko ØD | Tuotekoodi | LVI-koodi | Hinta €/kpl |
|---------|--------------|-----------|-------------|
| 100 | H10208100-2 | 8318804 | 60,15 |
| 125 | H10208125-2 | 8318805 | 61,35 |
| 160 | H10208160-2 | 8318806 | 80,19 |
| 200 | H10208200-2 | 8318807 | 81,88 |
| 250 | H10208250-2 | 8318808 | 98,56 |
| 315 | H10208315-2 | 8318809 | 129,67 |
| 400 | H10208400-2 | 8318810 | 168,73 |
| 500 | H10208500-2 | 8318811 | 253,92 |
| 630 | H10208630-2 | 8318812 | 319,10 |
| 800 | H10208800-2 | 8318813 | 666,61 |
| 1000 | H102081000-2 | 8318814 | 1119,35 |
| 1250 | H102081250-2 | 8318815 | 1453,47 |

Puhdistusluukku TLP-H

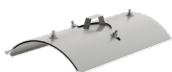

| Koko D | Tuotekoodi | LVI-koodi | Hinta €/kpl |
|--------|-------------|-----------|-------------|
| 100 | H10111006 | 8318816 | 279,42 |
| 125 | H10111226 | 8318817 | 279,42 |
| 160 | H10111626 | 8318818 | 279,42 |
| 200 | H10112026 | 8318819 | 383,18 |
| 250 | H10113250 | 8318820 | 383,18 |
| 315 | H10113026 | 8318821 | 383,18 |
| 400 | H10114026 | 8318822 | 383,18 |
| 500 | H10115026 | 8318823 | 440,24 |
| 630 | H10116326 | 8318824 | 638,15 |
| 800 | H10118026 | 8318825 | 638,15 |
| 1000 | H101100026 | 8318826 | 638,15 |
| 1250 | H10111226-0 | 8318657 | 638,15 |

Säätöpelti KROS-H



| Koko Ød | Tuotekoodi | LVI-koodi | Hinta €/kpl |
|---------|------------|-----------|-------------|
| 100 | H6210100 | 8417165 | 246,24 |
| 125 | H6210125 | 8417166 | 253,47 |
| 160 | H6210160 | 8417167 | 270,70 |
| 200 | H6210200 | 8417168 | 296,40 |
| 250 | H62102500 | 8417169 | 380,97 |
| 315 | H6210315 | 8417170 | 430,95 |
| 400 | H6210400 | 8417171 | 622,77 |
| 500 | H6210500 | 8417172 | 880,41 |
| 630 | H6210630 | 8417173 | 1245,38 |

Ilmanvaihtokanavajärjestelmät

13. NORDrect - Suorakaidekanavajärjestelmä

| | | | | | |
|--------------------------------|---------------------|--|-------------------------|--|--|
| Suorakaidekanava EKT | Käyrä EKP | Käyrä terävällä ulkoreunalla EKPK | S-kappale EKN | Muunto, (suorakaide- suorakaide) EKK | Muunto, (suorakaide-pyöreä) EKD |
|--------------------------------|---------------------|--|-------------------------|--|--|



| | | | | | |
|---|---|--|---|----------------------|---------------------|
| Lähtökaulus tasopinnalle ESS | Lähtökaulus tasopinnalle (kaarevalla sivulla) ESK | Lähtökaulus pyöreälle kanavalle ESD | Lähtökaulus pyöreälle kanavalle ESDR | T-yhde EKM | Pääty EKO |
|---|---|--|---|----------------------|---------------------|

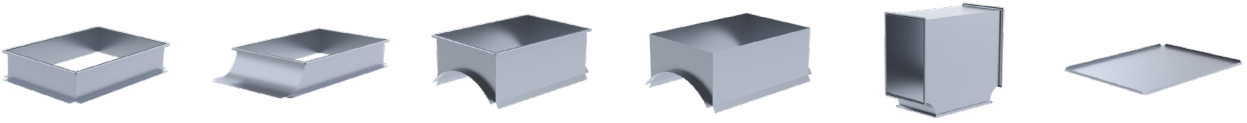

Hinnat tarjouksen mukaan.

14. NORDaccessories -Asennus- ja kiinnitystarvikkeet

| Koodi | LVI-koodi | Nimi | Hinta € | kpl/ laatikko |
|-----------|-----------|-------------------------------------|------------|------------------|
| 111602017 | 8331669 | Ilmastointisilikoni 310 ml ETS NORD | kpl 9,23 | |
| 111602014 | 8132494 | FireStop-silikoni 310 ml ETS NORD | kpl 16,48 | |
| 111610151 | 8351105 | IV-kuilukannake 100 mm | pari 3,91 | |
| 111610152 | 8351106 | IV-kuilukannake 125 mm | pari 4,07 | |
| 111610153 | 8351107 | IV-kuilukannake 160 mm | pari 4,66 | |
| 111610154 | 8351108 | IV-kuilukannake 200 mm | pari 4,98 | |
| 111610155 | 8351109 | IV-kuilukannake 250 mm | pari 5,71 | |
| 111610156 | 8351110 | IV-kuilukannake 315 mm | pari 6,48 | |
| 111610157 | 8351111 | IV-kuilukannake 400 mm | pari 7,04 | |
| 111610158 | 8351112 | IV-kuilukannake 500 mm | pari 13,15 | |
| 111610159 | 8351113 | IV-kuilukannake 630 mm | pari 16,89 | |
| 111610160 | 8351114 | IV-kuilukannake 800 mm | pari 22,60 | |
| 111610161 | 8351115 | IV-kuilukannake 1000 mm | pari 25,25 | |
| 111610162 | 8351116 | IV-kuilukannake 1250 mm | pari 29,69 | |
| 111610163 | 8351117 | IV-kuilukannakkeen jalka | kpl 5,60 | |
| 111610164 | 8351118 | IV-kuilukannakkeen putki | kpl 4,91 | |
| 111610165 | 3211860 | Kierreputki ontto 3/4" L=2 m | kpl 51,20 | |
| 111610166 | 3219149 | Runkolevy 3/4"-muhvilla | kpl 2,29 | |
| TA8352810 | 8352810 | I-sanka 100 mm M8 (60 kpl/ltk) | kpl 1,59 | 60 |
| TA8352812 | 8352812 | I-sanka 125 mm M8 (60 kpl/ltk) | kpl 1,68 | 60 |
| TA8352814 | 8352814 | I-sanka 160 mm M8 (60 kpl/ltk) | kpl 1,99 | 60 |
| TA8352816 | 8352816 | I-sanka 200 mm M8 (30 kpl/ltk) | kpl 2,20 | 30 |
| TA8352818 | 8352818 | I-sanka 250 mm M8 (30 kpl/ltk) | kpl 2,74 | 30 |
| TA8352820 | 8352820 | I-sanka 315 mm M8 (30 kpl/ltk) | kpl 3,42 | 30 |
| TA8352822 | 8352822 | I-sanka 400 mm M8 (15 kpl/ltk) | kpl 4,61 | 15 |
| 70304110 | 8353010 | I-sanka 100 mm | kpl 0,84 | |
| 70304112 | 8353012 | I-sanka 125 mm | kpl 1,17 | |
| 70304116 | 8353014 | I-sanka 160 mm | kpl 1,19 | |
| 70304120 | 8353016 | I-sanka 200 mm | kpl 1,50 | |
| 70304125 | 8353018 | I-sanka 250 mm | kpl 1,80 | |
| 70304131 | 8353020 | I-sanka 315 mm | kpl 2,34 | |
| 70304140 | 8353022 | I-sanka 400 mm | kpl 3,30 | |
| 70304150 | 8353024 | I-sanka 500 mm | kpl 4,68 | |
| 70304163 | 8353026 | I-sanka 630 mm | kpl 6,25 | |
| 70304180 | 8353028 | I-sanka 800 mm | kpl 8,31 | |
| 70304111 | 8353030 | I-sanka 1000 mm | kpl 9,38 | |
| 703041250 | 8353032 | I-sanka 1250 mm | kpl 10,32 | |
| 70304010H | 8338608 | I-sanka pikalukolla 100 mm M8 HST | pari 22,91 | |
| 70304012H | 8338609 | I-sanka pikalukolla 125 mm M8 HST | pari 27,09 | |
| 70304016H | 8338610 | I-sanka pikalukolla 160 mm M8 HST | pari 30,63 | |
| 70304020H | 8338611 | I-sanka pikalukolla 200 mm M8 HST | pari 37,22 | |
| 70304025H | 8338612 | I-sanka pikalukolla 250 mm M8 HST | pari 44,62 | |
| 70304031H | 8338613 | I-sanka pikalukolla 315 mm M8 HST | pari 52,86 | |
| 70304040H | 8338614 | I-sanka pikalukolla 400 mm M8 HST | pari 63,87 | |



Ilmanvaihtokanavajärjestelmät

| Koodi | LVI-koodi | Nimi | | Hinta € | kpl/ laatikko |
|------------|-----------|---|------|---------|------------------|
| 70304100H | 8338700 | I-sankapari 100 mm HST | pari | 15,97 | |
| 70304120H | 8338624 | I-sankapari 125 mm HST | pari | 17,08 | |
| 70304160H | 8338623 | I-sankapari 160 mm HST | pari | 17,94 | |
| 70304200H | 8338622 | I-sankapari 200 mm HST | pari | 19,07 | |
| 70304250H | 8338621 | I-sankapari 250 mm HST | pari | 23,38 | |
| 70304131H | 8338620 | I-sankapari 315 mm HST | pari | 26,35 | |
| 70304140H | 8338619 | I-sankapari 400 mm HST | pari | 29,72 | |
| 70304150H | 8338618 | I-sankapari 500 mm HST | pari | 33,93 | |
| 70304163H | 8338617 | I-sankapari 630 mm HST | pari | 43,87 | |
| 70304180H | 8338616 | I-sankapari 800 mm HST | pari | 53,36 | |
| 70304111H | 8338615 | I-sankapari 1000 mm HST | pari | 59,12 | |
| ER01756 | 8338701 | I-sankapari 1250 mm HST | pari | 101,57 | |
| 111603306 | 8331598 | Konsolikannake tuella 300 mm | kpl | 9,64 | |
| 85000400 | 3219103 | Konsolikannake tuella 400 mm | kpl | 16,86 | |
| 111603308 | 3219104 | Konsolikannake tuella 500 mm | kpl | 13,71 | |
| 85000600 | 8331599 | Konsolikannake tuella 600 mm | kpl | 20,78 | |
| 111603310 | 3219106 | Konsolikannake tuella 800 mm | kpl | 20,48 | |
| 85001000 | 8331650 | Konsolikannake tuella 1000 mm | kpl | 32,62 | |
| 111603314 | 8331651 | Konsolikannake tuella 1200 mm | kpl | 57,24 | |
| 70100056 | 8331652 | Kierretanko M8 L=2 m mm DIN 976 4,8 Zn (50 m/pussi) | m | 1,45 | 100 |
| 70500008 | 8331557 | L-asennuskisko 30x30x2 mm L=2 m | m | 6,79 | 20 |
| 70500009 | 8331558 | U-asennuskisko 30x30x2 mm L=2 m | m | 11,47 | 20 |
| 701000024 | 8331590 | C-työntölista L=2 m (ETS) | m | 0,82 | 100 |
| H70100003 | 8331591 | C-työntölista L=2 m, A4 AISI 316 (ETS) | m | 7,07 | |
| 701000261 | 8331592 | Z/IT-lista L=4 m | m | 3,15 | 100 |
| 701000411 | 8331593 | Z/IT-lista L=2 m | m | 3,70 | 50 |
| 70100031 | 8331581 | Z/IT-listan tiiviste L-profiili 16x13 (100 m/ltk) | m | 0,94 | 100 |
| H70100026 | 8331594 | Z/IT-lista IT Lista L=4 m A4 INOX 316 | m | 18,25 | |
| H701000271 | 8331597 | Z/IT-listan sisäkulma A4 AISI 316 | kpl | 0,58 | 250 |
| 701000271 | 8331595 | Z-listan sisäkulma (ETS) | kpl | 0,39 | 500 |
| 701000361 | 8331596 | Z-listan ulkokulma (ETS) | kpl | 0,29 | 100 |
| 70100037-1 | 8331583 | E205 Eurolista tiivistysmassalla DW20 (5 m/500 m pkt) | m | 3,03 | 500 |
| JP10020831 | 8331404 | E203 Eurolista DW20 tiivistysmassalla (3 m/300 m pkt) | m | 3,03 | 300 |
| JP10030831 | 8331424 | E303 Eurolista DW30 tiivistysmassalla (3 m/300 m pkt) | m | 3,61 | 300 |
| 70100039-1 | 8331584 | E305 Eurolista tiivistysmassalla DW30 (5 m/500 m pkt) | m | 3,61 | 500 |
| 70100005-1 | 8331586 | H30 Eurolistan sisäkulma | kpl | 0,87 | 250 |
| 70100004-1 | 8331585 | H21 Eurolistan sisäkulma | kpl | 0,41 | 500 |
| 70100014 | 8331589 | CM 3,0 listakiinnike ruuvilla, EURO | kpl | 0,58 | 500 |
| | | | | 0,00 | |
| 111610072 | 1486000 | Väriäkumi 100x100 mm s8 | kpl | 6,46 | |
| 111610073 | 1489028 | Väriänvaimennin B40/100X100X40 mm | kpl | 27,82 | |

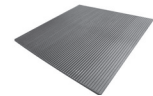
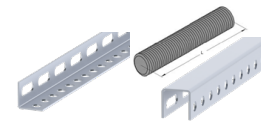

1. NORDgrille - Tulo-, poisto- ja siirtoilmasäleiköt



| | | | | |
|---|---|---|--|---|
| Tulo- ja poistoilmasäleikkö RSP | Poistoilmasäleikkö RSV | Tulo- ja poistoilmasäleikkö RPS | Tulo- ja poistoilmasäleikkö RPV | Lattiasäleikkö RPSL |
|  |  |  |  |  |
| Lattiasäleikkö RPVL | Siirtoilmasäleikkö RSO | Vaimentava siirtoilmasäleikkö RSL | Vaimentava siirtoilmasäleikkö RSM | Kiinnityskehys RSK |
|  |  |  |  |  |



Hinnat tarjouksen mukaan.

2. NORDdiffuser - Ilmanjakolaitteet

| | | | | |
|--|--|--|---|---|
| Tuloilmahajotin DEK | Tuloilmahajotin DEN | Tuloilmahajotin DKU | Tuloilmahajotin DDR | Suutinkanava DSP |
|  |  |  |  |  |

Hinnat tarjouksen mukaan.

| Tuloilmaventtiili DSS |  | Tuloilmaventtiili DVP |  | | | | | | | | | | | | | | | | | | | | | | | | | | | | | | | | | | | | | | | | | | | | | | | | | | | | | |
|--|---|------------------------------|---|--------------|--------------|-----|-------------|---------|-------|------|-----|-------------|---------|-------|------|-----|-------------|---------|-------|------|-----|--|--|--|--|-----|--|--|--|--|--|---|------------|-----------|-------------|--------------|------------|---------|------|-----|------------|---------|-------|-----|------------|---------|-------|-----|------------|---------|-------|-----|------------|---------|-------|-----|
| <table border="1"> <thead> <tr> <th>Koko Ød</th> <th>Tuotekoodi</th> <th>LVI-koodi</th> <th>Hinta €/kpl</th> <th>kpl/laatikko</th> </tr> </thead> <tbody> <tr> <td>100</td> <td>120223010-2</td> <td>8740140</td> <td>13,03</td> <td>• 20</td> </tr> <tr> <td>125</td> <td>120223011-2</td> <td>8740141</td> <td>18,89</td> <td>• 20</td> </tr> <tr> <td>160</td> <td>120223012-2</td> <td>8740142</td> <td>24,52</td> <td>• 15</td> </tr> <tr> <td>200</td> <td></td> <td></td> <td></td> <td></td> </tr> <tr> <td>250</td> <td></td> <td></td> <td></td> <td></td> </tr> </tbody> </table> | Koko Ød | Tuotekoodi | LVI-koodi | Hinta €/kpl | kpl/laatikko | 100 | 120223010-2 | 8740140 | 13,03 | • 20 | 125 | 120223011-2 | 8740141 | 18,89 | • 20 | 160 | 120223012-2 | 8740142 | 24,52 | • 15 | 200 | | | | | 250 | | | | | | <table border="1"> <thead> <tr> <th>Tuotekoodi</th> <th>LVI-koodi</th> <th>Hinta €/kpl</th> <th>kpl/laatikko</th> </tr> </thead> <tbody> <tr> <td>52120100-1</td> <td>8740143</td> <td>9,27</td> <td>• 7</td> </tr> <tr> <td>52120125-1</td> <td>8740144</td> <td>12,27</td> <td>• 7</td> </tr> <tr> <td>52120160-1</td> <td>8740145</td> <td>17,64</td> <td>• 7</td> </tr> <tr> <td>52120200-1</td> <td>8740146</td> <td>22,29</td> <td>• 7</td> </tr> <tr> <td>52120250-1</td> <td>8740147</td> <td>41,89</td> <td>• 7</td> </tr> </tbody> </table> | Tuotekoodi | LVI-koodi | Hinta €/kpl | kpl/laatikko | 52120100-1 | 8740143 | 9,27 | • 7 | 52120125-1 | 8740144 | 12,27 | • 7 | 52120160-1 | 8740145 | 17,64 | • 7 | 52120200-1 | 8740146 | 22,29 | • 7 | 52120250-1 | 8740147 | 41,89 | • 7 |
| Koko Ød | Tuotekoodi | LVI-koodi | Hinta €/kpl | kpl/laatikko | | | | | | | | | | | | | | | | | | | | | | | | | | | | | | | | | | | | | | | | | | | | | | | | | | | | |
| 100 | 120223010-2 | 8740140 | 13,03 | • 20 | | | | | | | | | | | | | | | | | | | | | | | | | | | | | | | | | | | | | | | | | | | | | | | | | | | | |
| 125 | 120223011-2 | 8740141 | 18,89 | • 20 | | | | | | | | | | | | | | | | | | | | | | | | | | | | | | | | | | | | | | | | | | | | | | | | | | | | |
| 160 | 120223012-2 | 8740142 | 24,52 | • 15 | | | | | | | | | | | | | | | | | | | | | | | | | | | | | | | | | | | | | | | | | | | | | | | | | | | | |
| 200 | | | | | | | | | | | | | | | | | | | | | | | | | | | | | | | | | | | | | | | | | | | | | | | | | | | | | | | | |
| 250 | | | | | | | | | | | | | | | | | | | | | | | | | | | | | | | | | | | | | | | | | | | | | | | | | | | | | | | | |
| Tuotekoodi | LVI-koodi | Hinta €/kpl | kpl/laatikko | | | | | | | | | | | | | | | | | | | | | | | | | | | | | | | | | | | | | | | | | | | | | | | | | | | | | |
| 52120100-1 | 8740143 | 9,27 | • 7 | | | | | | | | | | | | | | | | | | | | | | | | | | | | | | | | | | | | | | | | | | | | | | | | | | | | | |
| 52120125-1 | 8740144 | 12,27 | • 7 | | | | | | | | | | | | | | | | | | | | | | | | | | | | | | | | | | | | | | | | | | | | | | | | | | | | | |
| 52120160-1 | 8740145 | 17,64 | • 7 | | | | | | | | | | | | | | | | | | | | | | | | | | | | | | | | | | | | | | | | | | | | | | | | | | | | | |
| 52120200-1 | 8740146 | 22,29 | • 7 | | | | | | | | | | | | | | | | | | | | | | | | | | | | | | | | | | | | | | | | | | | | | | | | | | | | | |
| 52120250-1 | 8740147 | 41,89 | • 7 | | | | | | | | | | | | | | | | | | | | | | | | | | | | | | | | | | | | | | | | | | | | | | | | | | | | | |

| Poistoilmaventtiili DSE |  | Poistoilmaventtiili DVS |  | | | | | | | | | | | | | | | | | | | | | | | | | | | | | | | | | | | | | | | | | | | | | | | | | | | | | |
|---|---|--------------------------------|---|--------------|--------------|-----|-------------|---------|-------|------|-----|-------------|---------|-------|------|-----|-------------|---------|-------|------|-----|-------------|---------|-------|------|-----|--|--|--|--|--|---|------------|-----------|-------------|--------------|------------|---------|------|---|------------|---------|-------|---|------------|---------|-------|---|------------|---------|-------|---|------------|---------|-------|---|
| <table border="1"> <thead> <tr> <th>Koko Ød</th> <th>Tuotekoodi</th> <th>LVI-koodi</th> <th>Hinta €/kpl</th> <th>kpl/laatikko</th> </tr> </thead> <tbody> <tr> <td>100</td> <td>120216010-2</td> <td>8740131</td> <td>13,62</td> <td>• 24</td> </tr> <tr> <td>125</td> <td>120216011-2</td> <td>8740132</td> <td>17,56</td> <td>• 20</td> </tr> <tr> <td>160</td> <td>120216012-1</td> <td>8740133</td> <td>25,74</td> <td>• 15</td> </tr> <tr> <td>200</td> <td>120216013-1</td> <td>8740134</td> <td>31,04</td> <td>• 10</td> </tr> <tr> <td>250</td> <td></td> <td></td> <td></td> <td></td> </tr> </tbody> </table> | Koko Ød | Tuotekoodi | LVI-koodi | Hinta €/kpl | kpl/laatikko | 100 | 120216010-2 | 8740131 | 13,62 | • 24 | 125 | 120216011-2 | 8740132 | 17,56 | • 20 | 160 | 120216012-1 | 8740133 | 25,74 | • 15 | 200 | 120216013-1 | 8740134 | 31,04 | • 10 | 250 | | | | | | <table border="1"> <thead> <tr> <th>Tuotekoodi</th> <th>LVI-koodi</th> <th>Hinta €/kpl</th> <th>kpl/laatikko</th> </tr> </thead> <tbody> <tr> <td>52110100-1</td> <td>8740135</td> <td>9,57</td> <td>7</td> </tr> <tr> <td>52110125-1</td> <td>8740136</td> <td>12,66</td> <td>7</td> </tr> <tr> <td>52110160-1</td> <td>8740137</td> <td>18,23</td> <td>7</td> </tr> <tr> <td>52110200-1</td> <td>8740138</td> <td>23,01</td> <td>7</td> </tr> <tr> <td>52110250-1</td> <td>8740139</td> <td>43,26</td> <td>7</td> </tr> </tbody> </table> | Tuotekoodi | LVI-koodi | Hinta €/kpl | kpl/laatikko | 52110100-1 | 8740135 | 9,57 | 7 | 52110125-1 | 8740136 | 12,66 | 7 | 52110160-1 | 8740137 | 18,23 | 7 | 52110200-1 | 8740138 | 23,01 | 7 | 52110250-1 | 8740139 | 43,26 | 7 |
| Koko Ød | Tuotekoodi | LVI-koodi | Hinta €/kpl | kpl/laatikko | | | | | | | | | | | | | | | | | | | | | | | | | | | | | | | | | | | | | | | | | | | | | | | | | | | | |
| 100 | 120216010-2 | 8740131 | 13,62 | • 24 | | | | | | | | | | | | | | | | | | | | | | | | | | | | | | | | | | | | | | | | | | | | | | | | | | | | |
| 125 | 120216011-2 | 8740132 | 17,56 | • 20 | | | | | | | | | | | | | | | | | | | | | | | | | | | | | | | | | | | | | | | | | | | | | | | | | | | | |
| 160 | 120216012-1 | 8740133 | 25,74 | • 15 | | | | | | | | | | | | | | | | | | | | | | | | | | | | | | | | | | | | | | | | | | | | | | | | | | | | |
| 200 | 120216013-1 | 8740134 | 31,04 | • 10 | | | | | | | | | | | | | | | | | | | | | | | | | | | | | | | | | | | | | | | | | | | | | | | | | | | | |
| 250 | | | | | | | | | | | | | | | | | | | | | | | | | | | | | | | | | | | | | | | | | | | | | | | | | | | | | | | | |
| Tuotekoodi | LVI-koodi | Hinta €/kpl | kpl/laatikko | | | | | | | | | | | | | | | | | | | | | | | | | | | | | | | | | | | | | | | | | | | | | | | | | | | | | |
| 52110100-1 | 8740135 | 9,57 | 7 | | | | | | | | | | | | | | | | | | | | | | | | | | | | | | | | | | | | | | | | | | | | | | | | | | | | | |
| 52110125-1 | 8740136 | 12,66 | 7 | | | | | | | | | | | | | | | | | | | | | | | | | | | | | | | | | | | | | | | | | | | | | | | | | | | | | |
| 52110160-1 | 8740137 | 18,23 | 7 | | | | | | | | | | | | | | | | | | | | | | | | | | | | | | | | | | | | | | | | | | | | | | | | | | | | | |
| 52110200-1 | 8740138 | 23,01 | 7 | | | | | | | | | | | | | | | | | | | | | | | | | | | | | | | | | | | | | | | | | | | | | | | | | | | | | |
| 52110250-1 | 8740139 | 43,26 | 7 | | | | | | | | | | | | | | | | | | | | | | | | | | | | | | | | | | | | | | | | | | | | | | | | | | | | | |

Ilmanjakolaitteet

2. NORDdiffuser - Ilmanjakolaitteet

Tuloilmaventtiili
DSK-P (100, 125)
DSK (160, 200)

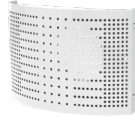

Kiinnityskehys kanavaan
RLT



| Koko Ød | Tuotekoodi | LVI-koodi | Hinta €/kpl | kpl/laatikko |
|---------|------------|-----------|-------------|--------------|
| 100 | EI00341-1 | 8632117 | 57,13 | • 12 |
| 125 | EI00342-1 | 8632118 | 57,95 | • 12 |
| 160 | KS01517-1 | 8632203 | 190,47 | |
| 200 | EI01117-1 | 8632204 | 219,52 | |

| Tuotekoodi | LVI-koodi | Hinta €/kpl | kpl/laatikko |
|------------|-----------|-------------|--------------|
| 120239011 | 8740148 | 3,60 | • 69 |
| 120239012 | 8740149 | 4,56 | • 44 |
| 120239013 | 8740150 | 5,41 | • 30 |
| 120239014 | 8740151 | 6,89 | • 20 |

Suutinhajotin
DKZ



Suutinhajotin liitäntälaatikolla
DRZ



| Koko Ød-A | Tuotekoodi | LVI-koodi | Hinta €/kpl |
|-------------|-------------|-----------|-------------|
| 125-300/300 | 110041002 | 8632206 | 120,62 |
| 125-450/300 | 110041003 | 8632207 | 122,38 |
| 125-600/300 | 110041004-1 | 8632208 | 185,77 |
| 160-300/300 | 110041005 | 8632209 | 122,38 |
| 160-450/300 | 110041006-1 | 8632210 | 122,38 |
| 160-600/300 | 110041007-1 | 8632211 | 185,77 |
| 200-450/450 | 110041008-1 | 8632212 | 151,44 |
| 200-600/450 | 110041009-1 | 8632213 | 191,05 |
| 250-600/600 | 110041010-1 | 8632214 | 224,52 |
| 315-600/600 | 110041011-1 | 8632215 | 233,32 |
| 400-600/600 | 110041012-1 | 8632216 | 252,68 |

| Koko Ød | Tuotekoodi | LVI-koodi | Hinta €/kpl |
|---------------|-------------|-----------|-------------|
| 400x150/100-1 | 110041030-1 | 8632223 | 244,01 |
| 400x150/100-2 | 110041031-1 | 8632224 | 244,01 |
| 400x200/125-1 | 110041032-1 | 8632225 | 247,56 |
| 400x200/125-2 | 110041033-1 | 8632226 | 247,56 |
| 500x200/160-1 | 110041034-1 | 8632227 | 266,03 |
| 500x200/160-2 | 110041035 | 8632228 | 266,03 |
| 600x250/200-1 | 110041036-1 | 8632229 | 303,02 |
| 600x250/200-2 | 110041037-1 | 8632230 | 303,02 |
| 750x300/250-1 | 110041038 | 8632231 | 345,13 |
| 750x300/250-2 | 110041039 | 8632232 | 345,13 |

Suutinhajotin liitäntälaatikolla
DEZ



| Koko Ød | Tuotekoodi | LVI-koodi | Hinta €/kpl |
|---------|-------------|-----------|-------------|
| 100 | 110041040-1 | 8632217 | 235,22 |
| 125 | 110041041-1 | 8632218 | 252,68 |
| 160 | 110041042-1 | 8632219 | 295,82 |
| 200 | 110041043-1 | 8632220 | 407,79 |
| 250 | 110041044-1 | 8632221 | 486,89 |
| 315 | 110041045-1 | 8632222 | 536,19 |

3. Liitäntälaatikot

Liitäntälaatikko kattohajottimille mittaus- ja säätöyhteillä
SKDM



Liitäntälaatikko tulo- ja poistoilmasäleiköille mittaus- ja säätöyhteillä
SKRM



Hinnat tarjouksen mukaan.

NORDcanopy - Keittiön ilmanvaihtolaitteet

NORDcanopy-tuoteryhmä käsittää suurkeittiöiden keittiölaitteiden yläpuolelle asennettavaksi tarkoitettuja ilmastointihuuvia. NORDcanopy-tuotteet on valmistettu ruostumattomasta teräksestä EVS-EN 10088-2:2005, EN 1.4301 tai AISI 304 (AISI 304) standardin mukaisesti.

Täydellinen valikoima tuotteista löytyy www.etsnord.fi/tuotteet > NORDcanopy

HZ - Otsonaattorihuuva

Integroidulla otsonaattorilla varustettu tulo- ja poistoilmahuuva, jonka tehokkaat rasvanpoisto- ja puhdistusominaisuudet takaavat puhtaan ja hygieenisen työympäristön. Huuva poistaa rasvaisen ilman ja ylimääräisen lämmön keittiöstä erottaen rasvan poistoilmasta.



HR - Tulo- ja poistoilmahuuva rasvanpoistoon

HR on keittiölaitteen yläpuolelle asennettava tulo- ja poistoilmahuuva, joka poistaa likaista ja ylikuumaa ilmaa ja erottaa siitä rasvaa. Tuloilma kulkee huoneeseen pääasiassa laitteen etupaneelin kautta sekä lisäksi työskentelyalueen säädettävien tuloilma-aukkojen kautta.



HU - Kondenssihuuva kosteudenpoistoon

HU-höyrykupu sopii kosteutta aiheuttavien keittiölaitteiden päälle – esimerkiksi astianpesukoneet. Laitte erottelee poistoilmasta vettä kondensoimalla. Lisävarusteena on saatavana pinta-asenteinen valaisin.



HT - Kohdepoistolaite

Tyhjä poistoilmahuuva. Huuvan avulla poistetaan työvyöhykkeeltä likaa ja ylimääräistä lämpöä. Sopii teollisuustuotantoon.

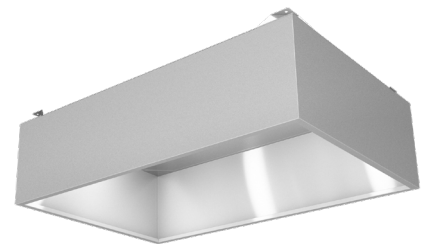

HFK - Rasvasuodatin

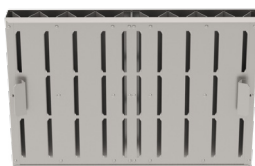

Rasvasuodatin suurkeittiöiden tai vastaavien tilojen keittiölaitteiden tuottaman rasvan ja muun lian erottamiseen poistoilmasta.

ETS NORD Apukäsi



ETS NORD Apukäden avulla ammattikeittiöt hoitavat rasvahuuvien suodattimien poistamisen puhdistusta varten helposti ja turvallisesti.

Hinnat tarjouksen mukaan.

NORDfan – puhaltimet

NORDfan -tuoteryhmämme sisältää poikkeuksellisen laajan valikoiman puhaltimia useille painetasoille ja ilmavirroille. Ilmamääräalueet voivat vaihdella 0,1–50 m³/s puhaltimen halkaisijan ollessa Ø 250–1600 mm. Puhaltimien hyötysuhde voi olla jopa yli 90%.

Meiltä saat mm:

- CE-merkityt aksiaalipuhaltimet savunpoistoon (F200, F300 ja F400)
- Katto- ja seinäasenteiset savunpoistopuhallin+luukku yhdistelmät (SPPIT ja SPPIT2)
- Suuntapainepuhaltimet autopaikoitustilojen ilmanvaihtoon ja savuhallintaan
- Sähkö- ja ohjauskeskukset erilaisiin savunhallintajärjestelmiin
- Jet-puhaltimet tunneleiden ilmanvaihtoon ja savunpoistoon
- Oviverhopuhaltimet ja kiertoilmalämmittimet erilaisiin tiloihin

Täydellinen valikoima tuotteista löytyy www.etsnord.fi/tuotteet>> NORDfan

Hinnat tarjouksen mukaan.



Recair-ilmankäsittelykoneet

Recair -tuoteryhmä koostuu pala- ja pakettikoneista. Palakoneita toimitetaan 0,3 - 10 m³/s ilmavirta-alueille ja pakettikoneita 0,3 - 4 m³/s ilmavirta-alueille.

Recair-ilmankäsittelykoneet voidaan koota erilaisista komponenteista. Näin saadaan tekniset suoritusarvot optimoitua asiakkaan tarpeisiin.

Pakettikoneen automaation taso on valittavissa juuri tarpeen mukaan: ilman automatiikkaa, riviliitinkeskuksella, sähkökeskuksella, RAU-varustetulla sähkökeskuksella tai omalla automatiikalla.

Recair-ilmankäsittelykoneita on saatavana erikoisratkaisuna myös hygienia- ja saneerauskohteisiin. Koneisiin on myös saatavilla erikoissuodattimia sekä ATEX-komponentteja.

Täydellinen valikoima tuotteista löytyy www.etsnord.fi/tuotteet > Recair

Hinnat tarjouksen mukaan.



| | | | |
|-----------------|--|---------------|--|
| Tilaja: | | Pvm.: | |
| Yhteyshenkilö: | | Tilausno: | |
| Puhelin: | | Proj. nro: | |
| Sähköposti: | | Projekti: | |
| Vastaanottaja: | | Laskutus: | |
| Toimitusosoite: | | | |
| Toimitustapa: | | Toimitusaika: | |

| | | | | | | | | | | | | | | |
|---------------|---|---|---|--------|-----------------|------|---|---|--------|-----------------|------|---|---|--------|
| EKT Kanava | | | | | EKP 90 Käyrä | | | | | EKP 45 Käyrä | | | | |
| | A | B | L | Liitos | | Kpl. | A | B | Liitos | | Kpl. | A | B | Liitos |
| | | | | | | | | | | | | | | |
| | | | | | | | | | | | | | | |
| | | | | | | | | | | | | | | |

| | | | | | | | | | | | | | | |
|---------------|---|---|---|---|---|-------------------------|----------|--------|------|---|---|----|--------|------|
| EKK Muunto | | | | | | ESD Lähtö- kaulus | | | | | | | | |
| | A | B | C | D | L | | Sijainti | Liitos | Kpl. | A | B | Ød | Liitos | Kpl. |
| | | | | | | | | | | | | | | |
| | | | | | | | | | | | | | | |
| | | | | | | | | | | | | | | |

| | | | | | | | | | | | | | | |
|---------------|---|---|----|---|----------|----------------|--------|------|---|---|---|---|--------|------|
| EKD Muunto | | | | | | EKM T-haara | | | | | | | | |
| | A | B | Ød | L | Sijainti | | Liitos | Kpl. | A | B | C | D | Liitos | Kpl. |
| | | | | | | | | | | | | | | |
| | | | | | | | | | | | | | | |
| | | | | | | | | | | | | | | |

| | | | | | | | | | | | | | | |
|------------------|---|---|---|---|-------------------------|--------|------|---|--------------|---|--------|------|---|---|
| EKN S-kappale | | | | | ESS Lähtö- kaulus | | | | EKO Pääty | | | | | |
| | A | B | s | L | | Liitos | Kpl. | A | | B | Liitos | Kpl. | A | B |
| | | | | | | | | | | | | | | |
| | | | | | | | | | | | | | | |
| | | | | | | | | | | | | | | |

Huomautukset:

| ESK Lähtö- kaulus | | | | TLT Puhdistus- luukku | | | TLTE Puhdistus- luukku | | | | TL1 | |
|-------------------------|---|--------|-----|-----------------------------|-----|-----|------------------------------|-----|---------|-----|---------|-----|
| A | B | Liitos | Kpl | A | B | Kpl | A | B | Eristys | Kpl | AxB | Kpl |
| | | | | 200 | 100 | | 200 | 100 | | | 300x200 | |
| | | | | 400 | 200 | | 400 | 200 | | | 400x200 | |
| | | | | 400 | 300 | | 400 | 300 | | | 400x300 | |
| | | | | 500 | 400 | | 500 | 400 | | | 500x400 | |
| | | | | 600 | 500 | | 600 | 500 | | | | |

Piirtämisen ohje:

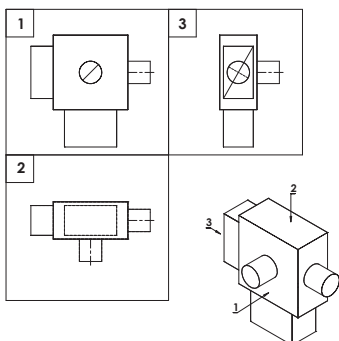

Liitoksen merkitseminen ja selitys:

Ilman merkintää on vakiona kanavan tai kanavaosan molemmissa päässä z-profiili. Eristetyn kanavan mitat ovat sisämitat ja liitoslista kiinnitetään vakiona ulkokuoreen, ellei toisin ole mainittu.

Z – Kanavan tai kanavaosan päädyssä Z-lista

Z+ – z-profiili toimitukseen mukaan irrallisena

NKV – Niittikaulus ulospäin kantattuna (mm)

NKS – Niittikaulus sisäänpäin kantattuna (mm)

E – kanavan tai kanavaosan päädyssä europrofiili (E20, E30)

E+ – Kanavan tai kanavaosan päädyssä europrofiili (E20, E30), mukaan irrallisena

LS – Eristetty kanava, jossa liitoslista kiinnitetään sisäkuoreen

Esimerkki: EKK 500x300(sk)-400x300 Muunto

| | | | |
|-----------------|--|---------------|--|
| Tilaja: | | Pvm.: | |
| Yhteyshenkilö: | | Tilausno: | |
| Puhelin: | | Proj. nro: | |
| Sähköposti: | | Projekti: | |
| Vastaanottaja: | | Laskutus: | |
| Toimitusosoite: | | | |
| Toimitustapa: | | Toimitusaika: | |

| | | | | | | | | | | | | | | |
|-----------------|---|---|---|--------|-------------------|------|---|---|--------|-------------------|------|---|---|--------|
| EKT-T Kanava | | | | | EKP-T 90 Käyrä | | | | | EKP-T 45 Käyrä | | | | |
| | A | B | L | Liitos | | Kpl. | A | B | Liitos | | Kpl. | A | B | Liitos |
| | | | | | | | | | | | | | | |
| | | | | | | | | | | | | | | |
| | | | | | | | | | | | | | | |

| | | | | | | | | | | | | | |
|-----------------|---|---|---|---|---|---------------------------|----------|--------|-----|---|---|----|--------|
| EKK-T Muunto | | | | | | ESD-T Lähtö- kaulus | | | | | | | |
| | A | B | C | D | L | | Sijainti | Liitos | Kpl | A | B | Ød | Liitos |
| | | | | | | | | | | | | | |
| | | | | | | | | | | | | | |
| | | | | | | | | | | | | | |

| | | | | | | | | | | | | | |
|-----------------|---|---|----|---|----------|------------------|--------|-----|---|---|---|---|--------|
| EKD-T Muunto | | | | | | EKM-T T-haara | | | | | | | |
| | A | B | Ød | L | Sijainti | | Liitos | Kpl | A | B | C | D | Liitos |
| | | | | | | | | | | | | | |
| | | | | | | | | | | | | | |
| | | | | | | | | | | | | | |

| | | | | | | | | | | | | | |
|--------------------|---|---|---|---|---------------------------|--------|------|---|---|-----------------|--------|-----|---|
| EKN-T S-kappale | | | | | ESS-T Lähtö- kaulus | | | | | EKOL-T Pääty | | | |
| | A | B | s | L | | Liitos | Kpl. | A | B | | Liitos | Kpl | A |
| | | | | | | | | | | | | | |
| | | | | | | | | | | | | | |
| | | | | | | | | | | | | | |

Tuotteen kuvaaminen piirustuksella

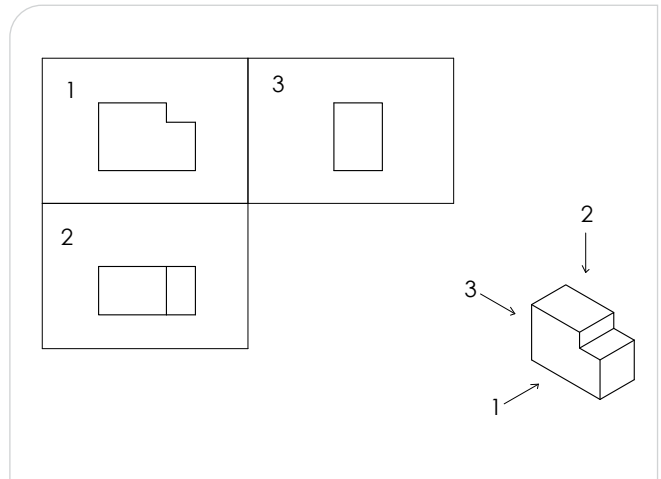
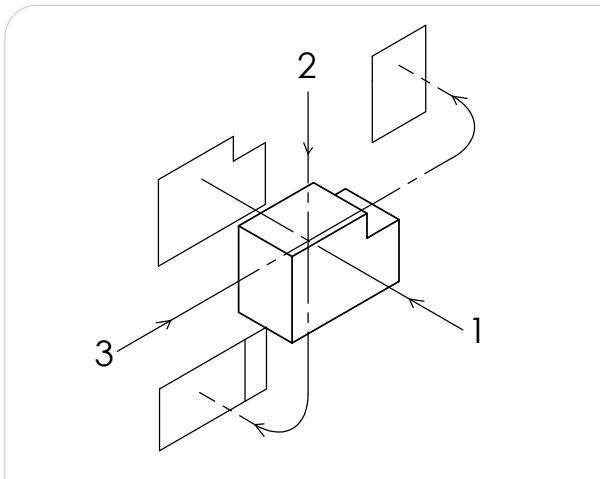

Viivat

Näkyvät muotoviivat _____

Näkymättömät muotoviivat - - - - -

Keskiviiva - - - - -

Liitoksen merkitseminen ja selitys:
Ilman merkintää on vakiona kanavan tai kanavaosan molemmissa päässä Z-profiili.
Eristetyn kanavan mitat ovat sisämitat ja liitoslista kiinnitetään vakiona ulkokuoreen, ellei toisin ole mainittu.

Z – Kanavan tai kanavaosan päädyssä Z-lista
Z+ – z-profiili toimitukseen mukaan irrallisena
NKV – Niittikaulus ulospäin kantattuna (mm)
NKS – Niittikaulus sisäänpäin kantattuna (mm)
E – kanavan tai kanavaosan päädyssä europrofiili (E20, E30)
E+ – Kanavan tai kanavaosan päädyssä europrofiili (E20, E30), mukaan irrallisena
LS – Eristetty kanava, jossa liitoslista kiinnitetään sisäkuoreen

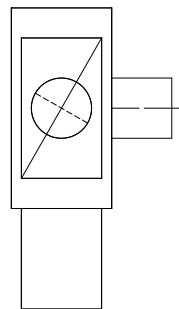
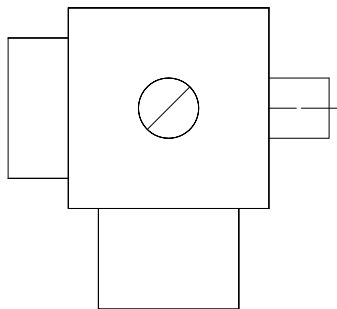

Näkyvällä puolella olevan reiän merkitseminen - **yhtenäisellä viivalla**

Näkymättömällä puolella olevan reiän merkitseminen - **katkoviivalla**

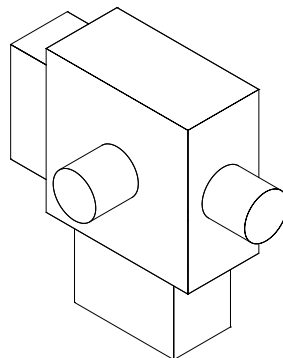
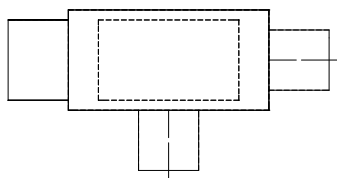

Liitostapamerkinntät

Liitoksen merkitseminen ja selitys:

Ilman merkintää on vakiona kanavan tai kanavaosan molemmissa päässä Z-profiili. Eristetyn kanavan mitat ovat sisämitat ja liitoslista kiinnitetään vakiona ulkokuoreen, ellei toisin ole mainittu.

Z – Kanavan tai kanavaosan päädyssä Z-lista

Z+ – z-profiili toimitukseen mukaan irrallisena

NKV – Niittikaulus ulospäin kantattuna (mm)

NKS – Niittikaulus sisäänpäin kantattuna (mm)

E – kanavan tai kanavaosan päädyssä europrofiili (E20, E30)

E+ – Kanavan tai kanavaosan päädyssä europrofiili (E20, E30), mukaan irrallisena

LS – Eristetty kanava, jossa liitoslista kiinnitetään sisäkuoreen

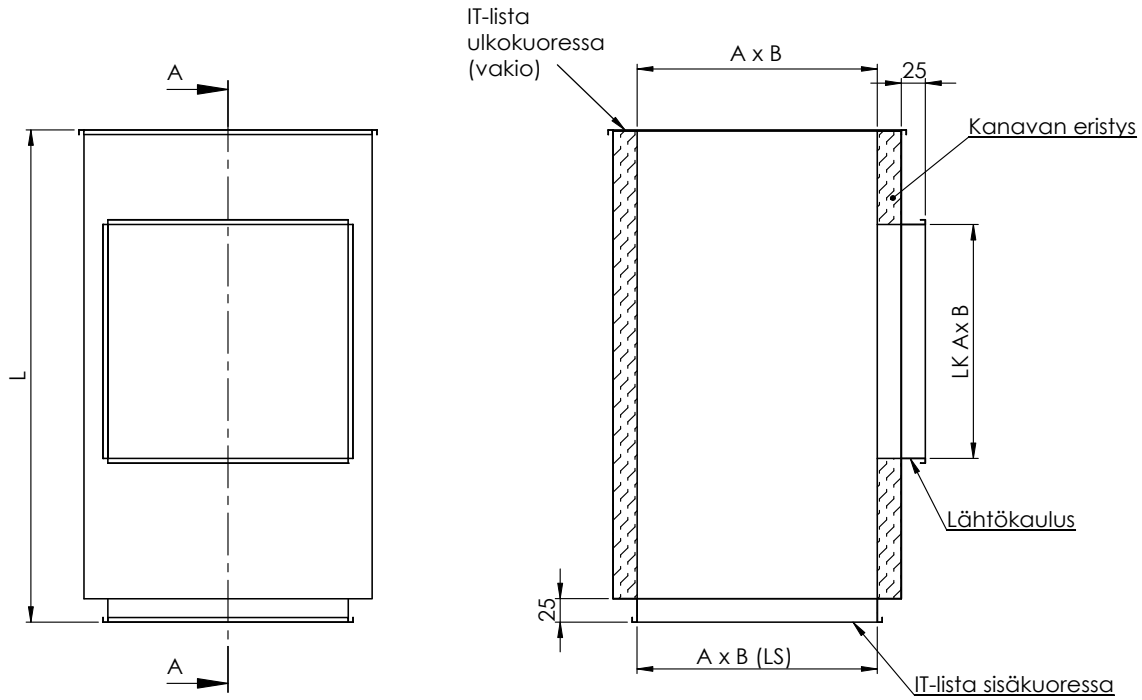

Kanavien eristys:

S – lämpöeriste, 30, 50, 100, ... mm

M – äänieriste, eristeen vahvuus 30, 50, 100, ... mm

CL – Äänieristetty kanava + pestävä eriste, 30, 50, 100mm

EI 60, 90, 120 – paloeriste (100 mm)

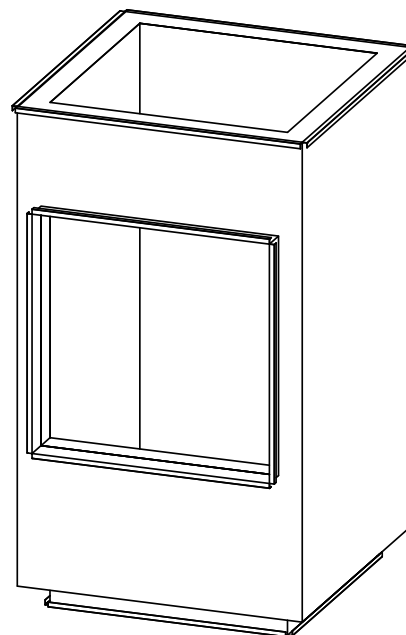

Kanavien ja kanavaosien pakkaukset

NORDduct kanavaosien pakkaukset

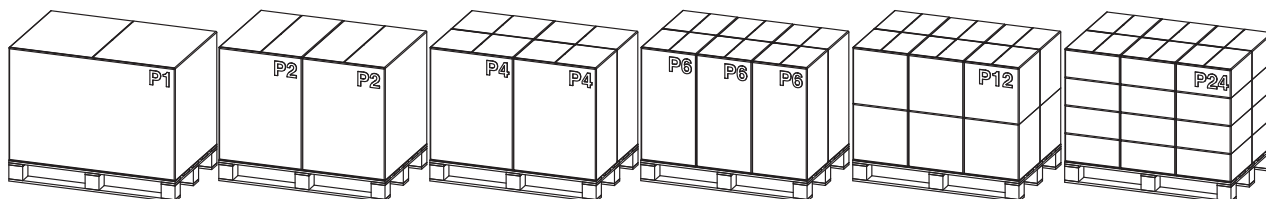

| Laatikon koodi | Pituus | Leveys | Korkeus | Määrä m ³ | Kpl/ alustalla |
|----------------|--------|--------|---------|----------------------|----------------|
| B1 | 1200 | 800 | 830 | 0,797 | 1 |
| B2 | 600 | 800 | 830 | 0,446 | 2 |
| B4 | 600 | 400 | 800 | 0,192 | 4 |
| B6 | 400 | 400 | 813 | 0,133 | 6 |
| B8 | 600 | 400 | 400 | 0,096 | 8 |
| B12 | 400 | 400 | 400 | 0,064 | 12 |
| B24 | 400 | 400 | 200 | 0,032 | 24 |

Kierresaumakanavien pakkauskoot

NORDduct-kierresaumakanavat toimitetaan puuhäkeissä. Kanavat Ø 100-315 mm voidaan toimittaa tilauksesta myös uudelleenkäytettävällä suojahupulla suojattuna. Suoja on avattavissa ja suljettavissa molemmista päistä.

| Tuote | 3m | | 6m | |
|---------|---------------|-----|---------------|-----|
| | Kpl/ Häkki | jm | Kpl/ Häkki | jm |
| NTO 100 | 126 | 378 | 252 | 756 |
| NTO 125 | 84 | 252 | 168 | 504 |
| NTO 160 | 51 | 153 | 102 | 306 |
| NTO 200 | 30 | 90 | 60 | 180 |
| NTO 250 | 20 | 60 | 40 | 120 |
| NTO 315 | 12 | 36 | 24 | 72 |
| NTO 400 | 6 | 18 | 12 | 36 |
| NTO 500 | 4 | 12 | 8 | 24 |



| Tuotekoodi | Nimi | Hinta €/kpl |
|------------|----------------------|----------------|
| 90790462 | Kanavahäkkisuoja 3 m | 15,00 |
| 90790466 | Kanavahäkkisuoja 6 m | 22,00 |



Yleiset toimitusehdot

1.Hinnat

Hinnaston hinnat ovat euroina arvonlisäverottomia 0% vapaasti tehtaallamme (EXW) välimyyntivarauksin.

2.Kuljetusvakuutukset ja kuljetusvahingot

Käytettäessä toimitusehtoa DAP työmaalla peritään asiakkaalta kuljetusvakuutuksen veloitus 0,65% laskun loppusummasta alv. 0%, jollei toisin ole sovittu. Kuljetusvakuutus korvaa kuljetuksen aikana sattuneen vahingon. Vahinko on todettava yhdessä vastaanottajan ja kuljettajan toimesta. Vahinko tulee merkitä rahtikirjaan.

3.Toimituskulut

Toimitettaessa tavaraa määräpaikkaan DAP, peritään asiakkaalta kuljetuksesta korvaus seuraavasti (ellei toisin ole sovittu):

Rahtiveloitus 4% laskun loppusummasta alv. 0%.

Minimirahtiveloitus 65 euroa/kuljetus.

4.Toimitusajat

Varastotuotteet 3-7 työpäivää. Muut tuotteet erillisen sopimuksen mukaan.

5.Pakkauskulut

Kierresaumakanavat Ø100-315 mm toimitetaan kertakäyttöpuuhäkissä. Puuhäkistä veloitamme 40 euroa/häkki. Pakkauksiin käytettävistä puulavoista veloitamme 8 euroa/lava.

P1- puhtausluokituksen mukaisesti toimitettavien tuotteiden pakkauslisäkustannus on 8%, jotka ei ole vakiopakattu P1-puhtausluokituksen mukaan.

6.Pientoimitukset

Käsittelykustannusten kattamiseksi perimme pientoimituslisän 20 € tavaralaskun nettoarvon jäädessä alle 200 € (alv. 0%).

7.Maksuehto

Maksuehto 14 pv netto, yliaikakorko 10%.

8.Voimassaoloaika

Tuotteiden hinnoittelussa käytetään kulloinkin viimeksi päivättyä hinnastoa. Tilaus ja tarjouspäivän hinta on voimassa enintään 3 kuukautta.

9.Omistusoikeus

Tuotteiden omistusoikeus siirtyy ostajalle, kun tavarankauppahinta on kokonaisuudessaan maksettu.

10.Välilliset vahingot

Myyjä ei vastaa välillisistä vahingoista, kuten tuotannosta johtuvasta, liikevaihdon vähentymisestä, saamatta jääneestä voitosta tai muusta vaikeasti ennakoitavasta vahingosta.

11.Palautukset

Palautettavaa tavaraa otamme vastaan ainoastaan, jos palautus johtuu omasta virheestämme.

12.Muut sopimusehdot

Kaikki oikeudet hinnaston muutoksiin pidätetään ilman ennakoilmoitusta. Muilta osin noudatamme TALTEK YT 2002-sopimusehtoja. Toimitusehtomme pätevät ainoastaan Suomessa.

ETS NORD yhteyshenkilöt

Myynti

| | |
|--------------------------------------|--|
| Avainasiakas-päällikkö | Veli-Matti Koskinen velimatti.koskinen@etsnord.fi 046 923 0922 |
| Etelä-Suomi: | Samuel Rutanen samuel.rutanen@etsnord.fi 0400 187 737 |
| Itä-Suomi: | Pasi Leskinen pasi.leskinen@etsnord.fi 040 5730 657 |
| Länsi- ja Pohjois-Suomi: | Jens Rönnqvist jens.ronnqvist@etsnord.fi 0400 562 801 |
| Savo, Kaakkois-Suomi ja Päijät-Häme: | Junnu Haara junnun.haara@etsnord.fi 040 848 4847 |
| Lounais-Suomi ja Pirkanmaa: | Janne Lehtonen janne.lehtonen@etsnord.fi 050 400 3300 |

NORDfan-tuotteet:

| | |
|--------------------------|--|
| Myyntipäällikkö: | Jarkko Lahti jarkko.lahti@etsnord.fi 0500 328 3022 |
| Tarjoukset ja tilaukset: | Heidi Hieta heidi.hieta@etsnord.fi 0400 278 838 |

RECAIR-ilmankäsittelykoneet

| | |
|----------------------------------|--|
| Tarjouslaskenta: | Heli Helimaa-Repo heli.helimaa-repo@recair.fi 050 315 6782 |
| Etelä-Suomi: | Jyrki Niemelä jyrki.niemela@recair.fi 040 556 0951 |
| | Matti Luoma matti.luoma@recair.fi 050 430 7760 |
| Pohjois-, Keski- ja Itä-Suomi: | Janne Jelekäinen janne.jelekainen@recair.fi 044 528 0843 |
| Pirkanmaa, Keski- ja Länsi-Suomi | Ilkka Sinisalo ilkka.sinisalo@recair.fi 040 825 6628 |

Kysy lisää, me autamme!

Tekniset palvelut

| | |
|--|---|
| NORDduct NORDsilencer NORDdoor NORDdiffuser NORDgrille IMS-tuotteet | Kadi Alber Tuoteryhmäpäällikkö kadi.alber@etsnord.fi 045 266 9999 |
| NORDfire NORDsmoke NORDdamper | Oskari Mattila Tuoteryhmäpäällikkö oskari.mattila@etsnord.fi 040 831 9120 |
| NORDrect | Andres Hiiesalu Tuoteryhmäpäällikkö & tekninen laskenta andres.hiiesalu@etsnord.fi 0400 354 342 |
| NORDfan | Jarkko Lahti Tuoteryhmäpäällikkö jarkko.lahti@etsnord.fi 0500 328 3022 |
| | Heidi Hieta Tarjoukset ja tilaukset heidi.hieta@etsnord.fi 0400 278 838 |
| NORDcanopy | Marcus Hintze Tuoteryhmäpäällikkö marcus.hintze@etsnord.fi 0440 304 896 |
| | Saku Ruusunen Tuoteryhmäpäällikkö & mitoitushjelmat saku.ruusunen@etsnord.fi 040 159 7265 |
| | Markus Tolonen Tekninen asiantuntija & suunnittelu markus.tolonen@etsnord.fi 045 133 8242 |
| NORDroof NORDexternal Suunnittelijat | Olli Suvisuo Tuotepäällikkö olli.suvisuo@etsnord.fi 040 150 8430 |

RECAIR-ilmankäsittelykoneet

| |
|---|
| Jarkko Salo Tuoteryhmäpäällikkö jarkko.salo@etsnord.fi 044 567 9601 |
| Aleksi Kähärä Kehityspäällikkö aleksi.kahara@recair.fi 040 544 7687 |
| Lauri Aaltio Mekaniikkasuunnittelija lauri.aaltio@recair.fi 040 563 8631 |
| Kimmo Kääriäinen Tekninen asiantuntija & suunnittelu kimmo.kaariainen@recair.fi 040 156 3707 |
| Paavo Kujala Automaatiosuunnittelija paavo.kujala@recair.fi 040 849 3145 |
| Antti Airas Tuotantopäällikkö antti.airas@recair.fi 040 737 5314 |

ETS NORD Huolto

| |
|--|
| Ari Asti Huoltopäällikkö ari.asti@etsnord.fi 040 197 3306 |
| Martti Sippola Huoltoinsinööri martti.sippola@etsnord.fi 040 194 0226 |

ETS NORD/RECAIR käyttönotot

| |
|-----------------------------------|
| 040 185 0317 huolto@etsnord.fi |
|-----------------------------------|

NORDduct



NORDrect



NORDsmoke



NORDsilencer



NORDdamper

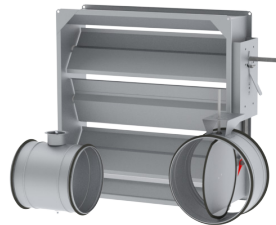

NORDfire



NORDroof



NORDExternal

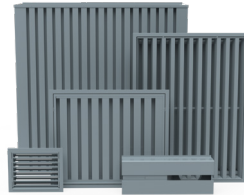

NORDdoor

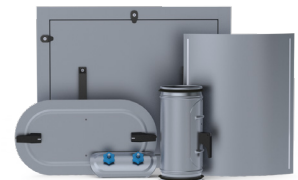

NORDdiffuser



NORDgrille



NORDcanopy



NORDaccessories

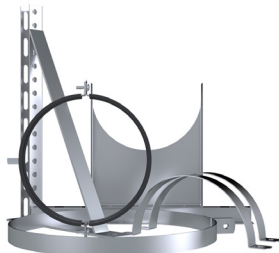

NORDfan

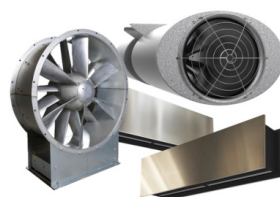

Recair



 **ETS NORD**

Pakkasraitti 4
04360 Tuusula
info@etsnord.fi
www.etsnord.fi

 **RECAIR**
ETS NORD

Pavintie 12
01260 Vantaa
info@etsnord.fi
www.etsnord.fi