

VERKKO
kauppa



 **ETS NORD**

Ilmanvaihtotuotteiden hinnasto

elokuu 2021

ETS NORD on Skandinavian johtava, nopeasti kasvava ja innovatiivisiin ilmanvaihtoratkaisuihin erikoistunut yritys. Olemme etujoukoissa luomassa uutta ja kestävästä sisätilamukavuuden tulevaisuutta. Tuotantomme ja varastomme sijaitsevat Tuusulassa, Vantaalla ja Tallinnassa. Huolellisesti suunniteltujen logistiikkajärjestelyjen myötä pystymme takaamaan asiakkaillemme tarkat ja nopeat toimitusajat.

Asiakaslähtöinen työskentely, jatkuva kehittäminen ja vastuullisuus ovat toimintamme kulmakiviä. Laatu- ja ympäristötavoitteiden toteuttamiseen osallistuu aktiivisesti koko ETS NORDin henkilökunta. Tuotekehityksemme perustuu tutkimustuloksiin, vankkaan kokemukseen ja uusiin innovaatioihin. Kuuntelemalla ja osallistamalla asiakkaitamme kykenemme tarjoamaan juuri heidän tarpeitaan vastaavia tuotteita ja ratkaisuja.

Laaja valikoimamme takaa erinomaisen ilmanvaihdon vaativimpaankin kohteeseen. Tuoteryhmiämme ovat muun muassa Eurofins-sertifioidut ja M1-puhtausluokitellut NORDDuct-kanavajärjestelmät, kotimaiset Avainlippu-merkityt Recair-ilmankäsittelykoneet, monipuoliset NORDCanopy-huuvut ja laaja NORDFan-puhallinvalikoima.

”Paras LVI-alan verkkokauppa”

Tilauksesi etenee aina nopeimmin helppokäyttöisen ja paljon kehitetyn verkkokaupпамme kautta. Voit pilkkoa ja ajastaa toimitukset saapumaan juuri haluttuna ajankohtana. Pyydä tunnukset verkkokaupпамme asiakaspalvelusta tai omalta vastuumyöjältäsi.

Lue lisää tuotteistamme ja kokonaisvaltaisista ilmanvaihdon ratkaisuista www.etsnord.fi.

Jari Lehtonen



SC0183-10





Ilmanvaihtokanavajärjestelmät

1. NORDduct - Pyöreä kanavajärjestelmä, galvanoitu	4
Kierresaumakanava	NTO
Kanava, pituussaumattu	NTOV
Käyrä 15, 30, 45, 90	NVP
Käyrä 15, 30, 45, 90	NV
Käyrä jyrkkä 90	NVK/NVKP/NVKPM
Sisäliitin	NI/NIL
Ulkoliitin	NM
Pitkä sisä-ulkoliitin	NILM
Lähtökaulus tasopinnalle	NSK/NSN/NSKM
Tulppa	NAL/NALM
Tulppa-puhdistusluukku	NALH/NALMH
Tulppa-puhdistusluukku, eristetty	NALH-E/NALMH-E
Liitinpää	MSG
Muunto, keskeinen	NFC/NFCM
Muunto, keskeinen	NFCV/NFCVM
Muunto, epäkeskeinen	NFB/NFBM
Lähtökaulus	NPS
Lähtökaulus	NPSK
Lähtökaulus	NPSV
T-yhde	NTKV
T-yhde	NTK
Imukartio suojaverkolla	NK/NP
Ristiinmenokappale	NTL
Saunakanava	TS
2. NORDdoor - Puhdistusluukut	12
Puhdistusluukku, kanavaosa	TLN3
Puhdistusluukku pyöreälle	TL3/TPL
Puhdistusluukku pyöreälle, eristetty	TLPE/TPLE
Puhdistusluukku tasopinnalle	TL1/TLT
Puhdistusluukku tasopinnalle, eristetty	TLTE
3. NORDdamper – Säätö- ja sulkupellit	13
Säätöpelti	KROS/KRI
Säätö- ja sulkupelti	KRTS-4
Ilmamääräsäädin	RPM-V, RPM-K, RPMC-V, RPMC-K
Sälepeltiliitin	KR2/KR4
Sälepeltiliitin	KR4-S
Perhospelti	RSKT
Säätö- ja sulkupelti	KRU
4. NORDsmoke - Savunhallintajärjestelmät	16
Pyöreä savunhallintajärjestelmä	
Savunhallintapellit	
5. NORDfire - Palotuotteet	22
Palopelti, pyöreä	FDMS, FDMD, FDMB-R, FDMA-R
Palopelti, suorakaide	FDMA, FDMB
6. ETScontrol	22
Palopeltien ohjaus- ja valvontajärjestelmä	
7. NORDsilencer - Äänenvaimentimet	23
Pyöreä äänenvaimennin	NRF/NRP
Pyöreä äänenvaimennin kasetilla	NRFB/NRPB
Äänenvaimennin, suorakaide-pyöreät liitokset, avattava	NKFA/NKPA
Äänenvaimennin	NKF/NKP
Äänenvaimennin	NKE
Taipuisa vaimennin	AKU-COMP
Suorakaidekanavien äänenvaimentimet	
8. NORDroof - Kattojärjestelmät	27
Ilmanottokatos	ULS/URS
Ilmanottokatos	ULK/ULSK
Ilmastointiokatos	UVE
Ulospuhallushajotin	ULV2/ULV2K
Sadekatos	NTH
Laippa	VRL
Kattoläpivienti	MKL
Alipainepelti	MKLT
Pyöreä liitin	MKLS
9. NORDexternal - Ulkosäleiköt ja lumisuojat	31
Ulkosäleikkö	RV/RVA
Lumisäleikkö	RVL/RVLU
Ulkosäleikkö lämmitettävillä säleillä	RVUK
Yhdistetty ulko- ja poistoilmalaite	RVC
10. Pyöreä kanavajärjestelmä, 1,2 mm	32
11. Pyöreä kanavajärjestelmä, Magnelis (ZM310)	35
12. Pyöreä kanavajärjestelmä, haponkestävät	42
13. NORDrect – Suorakaidekanavajärjestelmä	46
14. NORDaccessories - Asennustarvikkeet	47
Ilmanjakolaitteet	
1. NORDgrille – Tulo-, poisto- ja siirtoilmäsäleiköt	49
2. NORDdiffuser – Ilmanjakolaitteet	49
3. Liitäntälaatikot	50
Keittiön ilmanvaihtolaitteet	
NORDcanopy - Keittiön ilmanvaihtolaitteet	51
Otsonaattori	HZ
Tulo- ja poistoilmahuuva	HR
Kondenssihuuva	HU
Kohdepoistolaite	HT
Suodatin	HFK
NORDfan – Puhaltimet	52
Recair-ilmankäsittelykoneet	52
NORDrect-tilauslomake	54
NORDsmoke-tilauslomake	55
Tuotteen kuvaaminen piirustuksella	57
Kanavien ja kanavaosien pakkaukset	58
Yleiset toimitusehdot	59

Ilmanvaihtokanavajärjestelmät

Hinnat ovat arvonlisäverottomia (0%).

Varastotuotteet merkattu •

Kaikki mitat millimetreinä (mm), ellei toisin ole mainittu.

NORDduct

1. NORDduct - Pyöreä kanavajärjestelmä, galvanoitu

Kanavat ja kanavaosat standardin SFS-EN 10327 mukaan.

Ainevahvuus:

100...315 – 0,5 mm

400...800 – 0,7 mm

1000...1250 – 0,9 mm

Kierresaumakanava
Pituus 3 m, tulpattu
NTO-3



Kierresaumakanava
Pituus 6 m, tulpattu
NTO-6

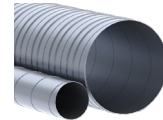

Koko Dø	Tuotekoodi	LVI-koodi	Hinta €/m		m/ häkki
80	10101083	8103307	17,96	•	450
100	10101013	8103322	13,06	•	378
125	10101123	8103323	14,43	•	252
160	10101163	8103324	18,07	•	153
200	10101203	8103325	23,30	•	90
250	10101253	8103326	29,86	•	60
315	10101313	8103327	35,89	•	36
400	10101403	8103328	60,53	•	18
500	10101503	8103329	80,53	•	12
630	10101633	8103330	102,04	•	
800	10101803	8103331	124,75	•	
1000	10101103	8103332	209,84	•	
1250	10101125-3	8103333	279,91	•	
1600	10101603	8103365	508,85		

Tuotekoodi	LVI-koodi	Hinta €/m		m/ häkki
110102000	8103309	17,96		
10101016	8103310	13,06	•	756
10101126	8103311	14,43	•	504
10101166	8103312	18,07	•	306
10101206	8103313	23,30	•	180
10101256	8103314	29,86	•	120
10101316	8103315	35,89	•	72
10101406	8103316	60,53	•	36
10101506	8103317	80,53	•	24
10101636	8103318	102,04	•	
10101806	8103319	124,75	•	
10101106	8103320	209,84	•	
10101125-6	8103321	279,91	•	
10101606	8103366	508,85		

Kanava (pituussaumattu)
NTOV

Ainevahvuus 0,7 mm
Max pituus
100...160 -1000 mm
200...1250 -2000 mm

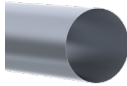

Koko dø	Tuotekoodi	LVI-koodi	Hinta €/kpl
100	10220100	8105858	36,85
125	10220125	8105859	43,01
160	10220160	8105860	52,51
200	10220200	8105861	96,16
250	10220250	8105862	116,83
315	10220315	8105863	141,74
400	10220400	8105864	173,19
500	10220500	8105865	213,00

Käyrä
NVP 90°



Koko dø	Tuotekoodi	LVI-koodi	Hinta €/kpl		kpl/ laatikko
80	110106000	8100092	19,81	•	85
100	10202019	8100094	10,97	•	55
125	10202129	8100096	13,33	•	30
160	10202169	8100098	19,30	•	65
200	10202209	8100100	32,68	•	40

Käyrä
NVP 60°



Tuotekoodi	LVI-koodi	Hinta €/kpl		kpl/ laatikko
10202016	8100852	20,67	•	40
10202126	8100853	21,43	•	22
10202166	8100854	35,64	•	20
10202206	8100855	37,81	•	12

Käyrä
NVP 45°



Koko dø	Tuotekoodi	LVI-koodi	Hinta €/kpl		kpl/ laatikko
80	110113002	8100122	12,91	•	16
100	10202014	8100124	11,26	•	60
125	10202124	8100126	11,46	•	50
160	10202164	8100128	18,61	•	25
200	10202204	8100130	24,89	•	60

Käyrä
NVP 30°



Tuotekoodi	LVI-koodi	Hinta €/kpl		kpl/ laatikko
10202013	8100153	12,72	•	75
10202123	8100154	14,96	•	40
10202163	8100155	18,23	•	22
10202203	8100156	24,77	•	20

Käyrä
NVP 15°



Tuotekoodi	LVI-koodi	Hinta €/kpl		kpl/ laatikko
10202013-1	8100872	10,48	•	18
10202123-1	8100873	16,39	•	27
10202163-1	8100874	16,76	•	15
102022015	8100875	21,37	•	12

NORDduct - Pyöreä kanavajärjestelmä, galvanoitu
**Käyrä
NV 90°**

Koko d _ø	Tuotekoodi	LVI-koodi	Hinta €/kpl	kpl/laatikko
250	10202259	8100102	43,98	• 18
315	10202319	8100104	55,30	• 8
400	10202409	8100106	72,12	• 4
500	10202509	8100108	96,35	• 2
630	10202639	8100110	174,48	•
800	10202809	8100112	382,59	•
1000	10202109	8100114	703,50	•
1250	10202125-9	8100116	1073,92	•

**Käyrä
NV 60°**

Tuotekoodi	LVI-koodi	Hinta €/kpl	kpl/laatikko
10202256	8100856	38,74	24
10202316	8100857	39,13	10
10202406	8100858	54,10	5
10202506	8100859	72,89	•
10202636	8100860	124,25	•
10202806	8100861	243,69	•
10202106	8100862	470,06	•
10202125-6	8100863	739,39	•

**Käyrä
NV 45°**

Tuotekoodi	LVI-koodi	Hinta €/kpl	kpl/laatikko
10202254	8100132	31,13	• 32
10202314	8100134	39,59	• 15
10202404	8100136	53,96	• 8
10202504	8100138	71,28	• 3
10202634	8100140	111,57	•
10202804	8100142	262,57	•
10202104	8100144	401,61	•
10202125-4	8100146	680,94	•

**Käyrä
NV 30°**

Koko d _ø	Tuotekoodi	LVI-koodi	Hinta €/kpl	kpl/laatikko
250	10202253	8100157	31,13	• 7
315	10202313	8100158	39,59	• 4
400	10202403	8100159	49,58	• 12
500	10202503	8100160	58,19	• 4
630	10202633	8100161	95,23	•
800	10202803	8100162	219,74	•
1000	10202103	8100163	372,73	•
1250	10202125-3	8100164	606,05	•

**Käyrä
NV 15°**

Tuotekoodi	LVI-koodi	Hinta €/kpl	kpl/laatikko
10202253-1	8100876	23,33	• 12
10202315	8100877	31,71	• 7
102024015	8100878	40,91	• 16
10202502	8100879	51,49	• 8
10202631	8100880	73,99	•
10202803-1	8100881	127,77	•
10202103-1	8100882	292,78	•
10202125-2	8100883	455,66	•

**Käyrä, jyrkkä
NVK 90°**

Tuotekoodi	LVI-koodi	Hinta €/kpl	kpl/laatikko
10202009	8100077	67,78	• 24
10203259	8100078	86,54	• 4
10203319	8100079	104,44	• 10
10203409	8100080	139,96	• 4
10203509	8100081	178,96	•
10203639	8100082	283,08	•
10203809	8100083	550,84	•
10203109	8100084	982,82	•
10203129	8100085	1457,98	•

**Käyrä, jyrkkä
NVKP 90°**

Koko d _ø	Tuotekoodi	LVI-koodi	Hinta €/kpl	kpl/laatikko
100	10201019	8100074	29,88	• 50
125	10201209	8100075	34,04	• 30
160	10201619	8100076	41,67	• 15
200				
250				
315				
400				
500				
630				

**Käyrä, jyrkkä
kanava/osa
NVKPM 90°**

Tuotekoodi	LVI-koodi	Hinta €/kpl	kpl/laatikko
110116020	8105793	40,45	• 50
110116021	8105794	47,38	• 30
110116022	8105795	58,04	• 15

**Käyrä, jyrkkä
kanava/osa
NVKM 90°**

Tuotekoodi	LVI-koodi	Hinta €/kpl	kpl/laatikko
110116019	8105890	81,46	• 13
110116024	8105798	105,69	• 4
110116025	8105799	134,32	• 10
110116026	8105800	180,19	• 4
110116027	8105801	230,23	•
110116028	8105802	349,85	•

Ilmanvaihtokanavajärjestelmät

NORDduct - Pyöreä kanavajärjestelmä, galvanoitu

Sisäliitin NI



Koko dø	Tuotekoodi	LVI-koodi	Hinta €/kpl	kpl/ laatikko
100	10203010	8100674	6,82	• 150
125	10203120	8100676	7,10	• 90
160	10203160	8100678	7,40	• 55
200	10203200	8100680	8,68	• 57
250	10203250	8100682	11,79	• 24
315	10203310	8100684	14,89	• 14
400	10203400	8100686	21,06	• 40
500	10203500	8100688	26,13	• 22
630	10203630	8100690	39,03	• 16
800	10203800	8100692	76,31	• 15
1000	10203100	8100694	125,65	•
1250	10203125	8100696	176,28	•

Pitkä sisäliitin NIL



Tuotekoodi	LVI-koodi	Hinta €/kpl	kpl/ laatikko
10217100	8103815	11,43	• 26
10217125	8103816	12,19	• 18
10217160	8103817	13,45	• 8
10217200	8103818	16,98	• 16
10217250	8103819	18,84	• 6
10217315	8103820	21,33	• 5
10217400	8103821	38,60	• 3
10217500	8103836	55,44	• 4
10217630	8103837	66,16	• 4
10217800	8103839	117,37	•
10217100-1	8103840	158,72	•
102171200	8103841	207,62	•

Ulkoliitin NM



Tuotekoodi	LVI-koodi	Hinta €/kpl	kpl/ laatikko
10204010	8100704	3,62	• 133
10204120	8100706	3,92	• 90
10204160	8100708	4,13	• 50
10204200	8100710	4,71	• 54
10204250	8100712	7,66	• 24
10204310	8100714	9,32	• 10
10204400	8100716	13,33	• 8
10204500	8100718	18,34	• 20
10204630	8100720	21,33	• 12
10204800	8100722	42,34	•
10204100	8100724	58,39	•
10204125	8100726	69,96	•

Pitkä sisä-ulkoliitin NILM



Koko dø	Tuotekoodi	LVI-koodi	Hinta €/kpl	kpl/ laatikko
100	10222100	8103902	13,21	• 9
125	10222125	8103906	13,63	• 13
160	10222160	8103908	14,62	• 8
200	10222200	8103910	17,65	• 9
250	10222250	8103912	20,86	• 6
315	10222315	8103914	23,63	• 4
400	10222400	8103916	42,51	• 3
500	10222500	8103918	63,70	•
630				
800				
1000				
1250				

Lähtökaulus tasopinnalle, jyrkkä NSK



Tuotekoodi	LVI-koodi	Hinta €/kpl	kpl/ laatikko
10205010	8100757	6,68	• 70
10205120	8100758	7,49	• 95
10205160	8100759	8,90	• 100
10205200	8100760	10,42	• 70
10205250	8100761	12,78	• 60
10205310	8100762	16,67	• 25
10205400	8100763	25,87	• 13
10205500	8100764	33,75	• 45
10205630	8100766	40,94	• 37
10205800	8100767	63,12	• 16
10205100	8100768	79,21	• 1
10205125	8100769	114,04	• 1

Lähtökaulus tasopinnalle, kartio NSN



Tuotekoodi	LVI-koodi	Hinta €/kpl	kpl/ laatikko
102059100	8100732	9,61	• 40
102059125	8100734	10,28	• 50
102059160	8100736	12,35	• 50
102059200	8100738	14,84	• 50
102059250	8100740	16,55	• 20
102059315	8100742	25,03	• 18
102059400	8100744	82,60	• 42
102059500	8100746	115,44	• 34
102059630	8100748	201,30	• 20

Lähtökaulus tasopinnalle, osalle NSKM



Koko Ød	Tuotekoodi	LVI- koodi	Hinta €/kpl	kpl/ laatikko
100	10206010	8100771	5,98	• 85
125	10206120	8100772	6,80	• 60
160	10206160	8100773	8,06	• 40
200	10206200	8100774	9,30	• 25
250	10206250	8100775	11,53	• 28
315	10206315	8100776	15,01	• 20
400	10206400	8100777	29,19	• 13
500	10206500	8100778	43,06	•
630	10206630	8100779	64,62	•
800	10206800-1	8100780	116,71	•
1000	10206100	8100781	148,28	•
1250	10206125	8100782	176,46	•

Tulppa kanavalle NAL



Tuotekoodi	LVI- koodi	Hinta €/kpl	kpl/ laatikko
10208010	8100644	13,05	• 90
10208120	8100646	13,50	• 110
10208160	8100648	14,15	• 36
10208200	8100650	17,00	• 45
10208250	8100652	26,10	• 25
10208310	8100654	35,21	• 22
10208400	8100656	51,78	• 12
10208500	8100658	54,60	• 36
10208630	8100660	76,15	• 24
10208800	8100662	140,05	• 12
10208100	8100664	162,28	•
10208150	8100666	228,55	•

Tulppa osalle NALM



Tuotekoodi	LVI- koodi	Hinta €/kpl	kpl/ laatikko
10208010-1	8100614	4,54	• 50
10208120-1	8100616	5,59	• 45
102081160-1	8100618	6,97	• 50
10208220-1	8100620	8,22	• 40
10208225-1	8100622	12,68	• 55
10208231-1	8100624	15,51	• 40
10208240-1	8100626	23,80	• 15
10208250-0	8100628	35,61	• 6
10208220-6	8100630	45,19	• 12
10208220-8	8100632	99,52	• 12
10208220-7	8100634	132,16	•
10208220-9	8100636	196,93	•

NORDduct - Pyöreä kanavajärjestelmä, galvanoitu
**Tulppa-puhdistusluukku
kanavalle
NALH**

Koko ød	Tuotekoodi	LVI-koodi	Hinta €/kpl	kpl/ laatikko
100	10208100-1	8318500	13,04	• 34
125	10208125-1	8318501	13,24	• 65
160	10208160-1	8318502	13,72	• 36
200	10208200-1	8318503	15,80	• 40
250	10208250-1	8318504	21,65	• 25
315	10208310-1	8318505	36,75	• 26
400	10208400-1	8318506	52,80	• 10
500	10208500-1	8318507	70,86	• 6
630	10208630-1	8318508	88,91	• 24
800	10208800-1	8318509	197,29	• 10
1000	102081000-1	8318510	254,80	
1250	102081250-1	8318511	357,22	

**Tulppa-puhdistusluukku
osalle
NALMH**

Tuotekoodi	LVI-koodi	Hinta €/kpl	kpl/ laatikko
10208100-2	8318512	11,25	• 50
10208125-2	8318513	11,96	• 36
10208160-2	8318514	14,08	• 25
10208200-2	8318515	16,89	• 30
10208250-2	8318516	25,33	• 16
10208315-2	8318517	28,15	• 16
10208400-2	8318518	64,76	• 10
10208500-2	8318519	68,99	• 6
10208630-2	8318520	73,19	• 24
10208800-2	8318521	133,74	• 10
10208101-2	8318522	161,87	
10208102-2	8318523	254,92	

**Tulppa-puhdistusluukku
kanavalle, paloeristetty
NALHE-EI60**

Tuotekoodi	LVI-koodi	Hinta €/kpl	kpl/ laatikko
10208100-3	8318524	34,43	• 21
10208125-3	8318525	37,47	• 27
10208160-3	8318526	43,63	• 30
10208200-5	8318527	47,35	• 20
10208125-4	8318528	56,15	• 12
10208125-6	8318529	80,42	• 11
10208400-0	8318530	99,01	• 8
10208500-0	8318531	126,40	
10208630-0	8318532	160,08	
10208800-0	8318533	247,91	
102081000-2	8318534	389,68	
102081250-2	8318535	516,67	

**Tulppa-puhdistusluukku
osalle, paloeristetty
NALMHE - EI60**

Koko ød	Tuotekoodi	LVI-koodi	Hinta €/kpl	kpl/ laatikko
100	10208250-8	8318536	34,43	• 21
125	10208250-9	8318537	37,47	• 27
160	10208250-10	8318538	43,63	• 16
200	10208200-3	8318539	47,35	• 20
250	10208250-4	8318540	56,15	• 12
315	10208250-7	8318541	80,42	• 11
400	10208200-10	8318542	99,01	
500	10208250-11	8318543	126,40	
630	10208250-12	8318544	160,08	
800	10208250-13	8318545	247,91	
1000	10208250-14	8318546	389,68	
1250	10208250-15	8318547	516,67	

**Liitinpää
MSG**

 Koot ø 100-315 mm L=50
 Koot ø 400-1250 mm L=70

Koko ød	Tuotekoodi	LVI-koodi	Hinta €/kpl	kpl/ laatikko
100-50	10225010	8105784	7,65	• 30
125-50	10225012	8105785	7,91	• 18
160-50	10225016	8105786	8,19	• 20
200-50	10225020	8105787	9,18	• 30
250-50	10225025	8105788	10,47	• 16
315-50	10225031	8105789	11,73	• 14
400-70	10225040	8105790	15,27	• 10
500-70	10225050	8105791	18,23	• 22
630-70	10225063	8105792	22,63	• 16
800-70	10225080	8105866	56,89	•
1000-70	10225101	8105867	82,13	
1250-70	10225122	8105868	106,64	

**Muunto, keskeinen
osa/osa
NFC**

Koko Ød1-d2	Tuotekoodi	LVI-koodi	Hinta €/kpl	kpl/ laatikko
125/100	10209121-0	8100518	13,04	• 63
160/100	10209160-1	8100520	13,30	• 30
160/125	10209161-2	8100522	14,04	• 35
200/100	10209200-1	8100524	17,42	• 42
200/125	10209201-2	8100526	17,87	• 24
200/160	10209201-6	8100528	20,33	• 24
250/160	10209251-6	8100532	23,92	• 32
250/200	10209252-0	8100534	23,92	• 32
315/160	10209311-6	8100536	29,38	• 17
315/200	10209312-0	8100538	29,38	• 18
315/250	10209312-5	8100540	30,96	• 19

**Muunto, keskeinen
kanava/osa
NFCM**

Koko Ød1-d2	Tuotekoodi	LVI-koodi	Hinta €/kpl	kpl/ laatikko
125/100	10279121-0	8100428	11,55	• 63
160/100	10279160-1	8100430	11,88	• 35
160/125	10219161-2	8100432	11,88	• 35
200/100	10279200-1	8100434	14,30	• 24
200/125	10279201-2	8100436	14,30	• 28
200/160	10279201-6	8100438	15,15	• 32
250/160	10279251-6	8100444	20,52	• 32
250/200	10279252-0	8100446	20,52	• 36
315/160	10279311-6	8100448	25,49	• 21
315/200	10279312-0	8100450	25,49	• 21
315/250	10279312-5	8100452	25,49	• 21

Ilmanvaihtokanavajärjestelmät

NORDduct - Pyöreä kanavajärjestelmä, galvanoitu

**Muunto, keskeinen
osa/osa
NFCV**



Koko Ød1-d2	Tuotekoodi	LVI- koodi	Hinta €/kpl	kpl/ laatikko
250/100	10209250-2	8105803	36,72	6
315/125	10209311-3	8100535	43,18	5
400/160	10209401-6	8100541	64,51	1
400/200	10209402-0	8100542	67,48	7
400/250	10209402-5	8100544	69,10	8
400/315	10209403-1	8100546	70,72	8
500/200	10209502-0	8100554	85,16	1
500/250	10209502-5	8100547	85,16	10
500/315	10209503-1	8100548	85,16	12
500/400	10209504-0	8100549	87,92	17
630/160	102096316-5	8105871	97,35	
630/200	102096320-5	8105706	97,35	1
630/250	10209632-5	8100555	101,29	1
630/315	10209633-1	8100550	106,20	1
630/400	10209634-0	8100551	111,13	1
630/500	10209635-0	8100552	112,43	
800/315	10209807-3	8105707	220,25	
800/400	10209807-0	8105708	220,25	
800/500	10209809-0	8105709	221,81	
800/630	10209806-0	8105710	280,65	
1000/315	102091000-2	8105872	324,20	
1000/400	102091000-4	8105711	324,20	
1000/500	102091000-5	8105712	323,72	
1000/630	102091000-6	8105713	331,21	
1000/800	102091000	8105714	338,58	
1250/500	110129054	8105807	533,29	
1250/630	110129055	8105808	551,34	
1250/800	102090800	8105715	555,33	
1250/1000	102091250	8105716	555,33	

**Muunto, keskeinen
kanava/osa
NFCVM**



Koko Ød1-d2	Tuotekoodi	LVI- koodi	Hinta €/kpl	kpl/ laatikko
250/100	10279250-2	8105771	37,65	
250/125	10279251-3	8105772	37,65	
250/160	10279251-7	8105773	38,65	
250/200	10279252-1	8105774	39,65	
315/125	10279311-3	8105775	44,45	
315/160	10279311-7	8105776	45,44	
315/200	10279312-2	8105777	45,44	8
315/250	10279312-7	8105778	46,14	
400/160	10279401-6	8105779	60,63	
400/200	10279402-0	8105780	62,03	
400/250	10279402-5	8105781	62,03	4
400/315	10279403-1	8105782	62,03	5
500/200	10279502-0	8103230	78,34	
500/250	10279502-5	8103231	83,95	
500/315	10279503-1	8103232	83,95	16
500/400	10279504-0	8103233	83,95	16
630/250	10279632-5	8103238	100,37	
630/315	10279633-1	8103239	102,42	
630/400	10279634-0	8103240	102,42	
630/500	10279635-0	8103241	102,42	7
800/400	110131037	8105810	199,84	
800/500	110131038	8105811	199,84	
800/630	10279806-0	8105783	199,84	
1000/400	110131039	8105812	207,37	
1000/500	110131040	8105813	207,37	
1000/630	110131041	8105814	207,37	
1000/800	110131042	8105815	208,87	
1250/500	110131043	8105816	311,77	
1250/630	110131044	8105817	330,62	
1250/800	110131045	8105818	330,62	
1250/1000	110131046	8105819	345,64	

**Muunto, epäkeskeinen
kanava/osa
NFBM**



Koko ØD-d2	Tuotekoodi	LVI- koodi	Hinta €/kpl
125/100	10289125-0	8100464	28,77
160/100	10289160-0	8100465	29,75
160/125	10289101-0	8100466	30,33
200/100	10289201	8100467	32,46
200/125	10289201-5	8100468	33,34
200/160	10289201-1	8100469	34,33
250/100	10289252-2	8100470	41,25
250/125	10289251-2	8100471	41,83
250/160	102892516	8100472	44,00
250/200	10289252-1	8100473	44,00
315/125	110133012	8100475	49,62
315/160	10289312-2	8100476	50,43
315/200	10289320	8100477	50,43
315/250	10289312-1	8100478	51,21
400/160	110133018	8100479	65,53
400/200	10289402-2	8100480	67,11
400/250	10289415-2	8100482	67,11
400/315	10289403-0	8100484	77,18
500/200	110133025	8100485	87,25
500/250	10289503-2	8100486	86,27
500/315	10289503-0	8100488	86,27
500/400	10289504-1	8100490	83,88
630/250	10289632-0	8100491	104,45
630/315	10289633-0	8100492	106,19
630/400	10289633-4	8100494	107,19
630/500	10289635-1	8100496	104,58
800/315	10289803-1	8100497	202,16
800/400	10289804-0	8100498	202,16
800/500	10289805-0	8100500	202,16
800/630	10289806-0	8100501	205,29
1000/500	10289105-0	8100502	323,97
1000/630	10289106-3	8100503	323,97
1000/800	10289108-0	8100504	333,64
1250/630	10289156-3	8100505	540,74
1250/800	10289158-0	8100506	543,62
1250/1000	10289151-0	8100508	610,36

**Muunto, epäkeskeinen
osa/osa
NFB**



Koko Ød1-d2	Tuotekoodi	LVI- koodi	Hinta €/kpl	kpl/ laatikko	Koko Ød1-d2	Tuotekoodi	LVI- koodi	Hinta €/kpl	kpl/ laatikko	Koko Ød1-d2	Tuotekoodi	LVI- koodi	Hinta €/kpl
125/100	10209101-1	8100556	31,42	18	400/125	10209412-1	8105820	64,17		630/500	10209635-1	8100588	107,07
160/100	10209101-3	8100557	32,63	10	400/160	10209412-2	8100571	65,53	4	800/315	10209803-1	8100589	217,59
160/125	10209101-0	8100558	32,63	16	400/200	10209402-2	8100572	65,53	5	800/400	10209804-0	8100590	217,59
200/125	102092012-1	8100560	30,44	6	400/250	10209415-2	8100574	66,38	6	800/500	10209805-0	8100592	234,34
200/160	10209201-1	8100561	30,44	15	400/315	10209403-0	8100576	67,11	7	800/630	10209806-3	8100594	279,08
250/100	10209251-3	8100562	36,23	10	500/200	102095200-2	8100577	74,15	8	1000/400	110132049	8100595	321,90
250/125	10209251-4	8100563	37,35	10	500/250	10209503-2	8100578	84,68	10	1000/500	102091000-3	8100596	321,90
250/160	10209251-1	8100564	38,03	12	500/315	10209503-0	8100580	86,32	12	1000/630	10209106-3	8100598	329,35
250/200	10209252-1	8100565	38,03	12	500/400	10209504-1	8100582	87,43	16	1000/800	10209108-0	8100600	336,67
315/125	1020931125-1	8100567	42,59	8	630/200	10209620-0	8105824	93,38		1250/630	10209156-3	8100602	542,94
315/160	1020931160-1	8100568	42,44	8	630/250	10209625-0	8100583	97,52	4	1250/800	10209158-0	8100604	548,75
315/200	102093120-1	8100569	42,44	9	630/315	10209633-0	8100584	110,51	10	1250/1000	10209151-0	8100606	552,21
315/250	1020931250-1	8100570	43,42	10	630/400	10209633-4	8100586	110,51	8				

NORDduct - Pyöreä kanavajärjestelmä, galvanoitu
**Lähtökaulus
NPS**

Koko Ød1-d2	Tuotekoodi	LVI-koodi	Hinta €/kpl	kpl/ laatikko
100/100	10206010-1	8100288	8,08	• 80
125/100	10206120-1	8100292	8,37	• 80
125/125	10206121-2	8100294	8,85	• 40
160/100	10206160-1	8100298	8,97	• 90
160/125	10206161-2	8100300	9,70	• 50
160/160	10206161-6	8100302	12,79	• 22
200/100	10206200-1	8100306	8,56	• 90
200/125	10206201-2	8100308	8,99	• 52
200/160	10206201-6	8100310	12,79	• 25
200/200	10206202-0	8100312	17,62	• 32
250/100	10206250-1	8100316	10,16	• 90
250/125	10206251-2	8100318	10,88	• 50
250/160	10206251-6	8100320	11,46	• 36
250/200	10206252-0	8100322	17,52	• 32
250/250	10206252-5	8100324	21,05	• 20
315/100	10206310-1	8100326	12,79	• 100
315/125	10206311-2	8100328	14,40	• 54
315/160	10206311-6	8100330	16,01	• 32

Koko Ød1-d2	Tuotekoodi	LVI-koodi	Hinta €/kpl	kpl/ laatikko
315/200	10206312-0	8100332	16,53	• 32
315/250	10206312-5	8100334	21,91	• 24
315/315	10206313-1	8100336	28,27	• 60
400/100	10206400-1	8100338	14,51	• 50
400/125	10206401-2	8100340	15,20	• 75
400/160	10206401-6	8100342	16,01	• 60
400/200	10206402-0	8100344	21,05	• 36
400/250	10206402-5	8100346	21,91	• 24
400/315	10206403-1	8100348	26,40	• 60
500/100	10206400-1	8100338	14,51	• 50
500/125	10206401-2	8100340	15,20	• 75
500/160	10206501-6	8100356	23,03	• 40
500/200	10206502-3	8100358	30,33	• 38
500/250	10206502-1	8100360	40,86	• 22
500/315	10206503-3	8100362	42,87	• 13
630/200	10206632-1	8100374	30,49	• 38
630/250	10206632-2	8100376	36,75	• 22
630/315	10206633-2	8100378	49,38	• 13

**Lähtökaulus,
lyhyt kaulus
NPSK**

Koko Ød1-d2	Tuotekoodi	LVI-koodi	Hinta €/kpl	kpl/ laatikko
160/125	10206161-3	8105717	32,28	
160/160	10206161-1	8105718	33,82	
200/160	10206202-K	8105719	35,36	
200/200	10206203-K	8105720	36,89	
250/160	10206251-K	8105721	38,45	
250/200	10206252-1	8105722	39,99	
250/250	102062525	8105723	43,06	
315/160	110135018	8105724	47,51	
315/200	102063120	8105725	49,22	
315/250	102063125	8105726	59,73	
315/315	102063131	8105727	68,77	
400/160	102064016	8105728	47,51	
400/200	102064020	8105729	50,77	
400/250	102064025	8105730	59,73	
400/315	10206403-K	8105731	68,77	
400/400	10206404-K	8105732	74,89	• 6
500/160	102065016	8105733	47,51	
500/200	10206502-0	8105734	50,77	35
500/250	10206502-5	8105735	59,73	24
500/315	10206503-1	8105736	68,77	35
500/400	10206504-K	8105737	74,89	• 6
500/500	10206505-K	8105738	82,93	•
630/160	10206631-6	8105739	47,51	16
630/200	10206632-0	8105740	50,77	10
630/250	10206632-5	8105741	59,73	24
630/315	10206633-1	8105742	68,77	25
630/400	10206634-K	8105743	74,89	• 6

Koko Ød1-d2	Tuotekoodi	LVI-koodi	Hinta €/kpl	kpl/ laatikko
630/500	10206635-K	8105744	82,93	•
630/630	102066363	8105745	163,17	•
800/160	10206831-6	8105746	47,51	•
800/200	10206802-0	8105747	50,77	•
800/250	10206802-5	8105748	59,73	• 10
800/315	10206803-1	8105749	68,77	• 10
800/400	10206804-K	8105750	74,89	•
800/500	102068050	8105751	82,93	•
800/630	10206806-K	8105752	163,17	•
800/800	102068080	8105753	163,17	•
1000/200	10206103-2	8105754	47,51	•
1000/250	10206103-4	8105755	59,73	•
1000/315	10206103-1	8105756	68,77	• 8
1000/400	102061040	8105757	74,89	
1000/500	102061050	8105758	82,93	
1000/630	102061063	8105759	173,96	
1000/800	10206108-1	8105760	173,96	
1000/1000	102061010	8105761	277,18	
1250/200	102061520-0	8105762	47,51	
1250/250	102061525-0	8105763	59,73	
1250/315	10206153-0	8105764	68,77	
1250/400	10206154-0	8105765	74,89	
1250/500	10206155-0	8105766	82,93	
1250/630	102061563	8105767	173,96	
1250/800	10206168-1	8105768	173,96	
1250/1000	102061510	8105769	277,18	
1250/1250	102061512	8105770	277,18	

Ilmanvaihtokanavajärjestelmät

NORDduct - Pyöreä kanavajärjestelmä, galvanoitu

Lähtökaulus
NPSV

Koko ØD-d2	Tuotekoodi	LVI-koodi	Hinta €/kpl	kpl/ laatikko
400/400	10206404-0	8100350	69,47	• 16
500/400	10206504-0	8100364	75,43	• 16
500/500	10206505-0	8100366	88,15	• 14
630/400	10206634-0	8100380	78,09	• 16
630/500	10206635-0	8100382	99,34	• 8
630/630	10206636-3	8100384	130,99	• 5
800/400	10206804-0	8100390	99,34	•
800/500	10206805-0	8100392	116,57	•
800/630	10206806-3	8100394	150,47	•
800/800	10206808-0	8100396	195,06	•
1000/400	10206104-0	8100397	155,60	•
1000/500	10206105-0	8100398	169,41	•
1000/630	10206106-3	8100400	194,93	•
1000/800	10206108-0	8100402	285,23	•
1000/1000	10206102-0	8100404	351,51	•
1250/400	10206168-4	8100419	345,16	10
1250/500	10206168-5	8100405	353,60	7
1250/630	10206156-3	8100406	363,49	7
1250/800	10206168-0	8100408	368,15	
1250/1000	10206151-0	8100410	400,53	
1250/1250	10206151-5	8100412	554,21	

T-yhde
NTKV

Koko ØD-d2	Tuotekoodi	LVI-koodi	Hinta €/kpl	
400/400	10207404-0	8100240	124,05	•
500/400	10207636-6	8100246	171,38	•
500/500	10207636-7	8100248	185,64	•
630/400	10207504-9	8100252	234,29	•
630/500	10207504-3	8100254	253,59	•
630/630	10207504-4	8100256	290,17	•
800/400	10207508-4	8100258	366,92	
800/500	10207508-5	8100260	382,59	
800/630	10207508-6	8100262	511,27	
800/800	10207509-1	8100264	585,26	•
1000/400	10207508-1	8103189	654,76	
1000/500	10207508-7	8100266	661,57	
1000/630	10207508-8	8100268	779,84	
1000/800	10207508-80	8100270	911,40	
1000/1000	10207508-9	8100272	1080,46	
1250/400	110138039	8103191	875,57	
1250/500	110138040	8103192	977,40	
1250/630	10207510	8100274	1082,97	
1250/800	10207509-9	8100275	1155,49	
1250/1000	10207121-1	8100276	1229,30	
1250/1250	10207121-5	8100277	1352,25	

T-yhde
NTK

Koko Ød1-d2	Tuotekoodi	LVI-koodi	Hinta €/kpl	kpl/ laatikko	
100/100	10207010-1	8100184	21,42	•	30
125/100	10207120-1	8100188	22,55	•	24
125/125	10207121-2	8100190	24,38	•	28
160/100	10207160-1	8100194	24,23	•	21
160/125	10207161-2	8100196	25,35	•	18
160/160	10207161-6	8100198	30,05	•	16
200/100	10207200-1	8100202	29,17	•	12
200/125	10207201-2	8100204	31,92	•	12
200/160	10207201-6	8100206	34,39	•	36
200/200	10207202-0	8100208	39,47	•	36
250/100	10207252-2	8100212	35,97	•	6
250/125	10207252-1	8100214	37,58	•	6
250/160	10207256-1	8100216	41,91	•	24
250/200	10207252-4	8100218	47,74	•	22
250/250	10207252-5	8100220	62,55	•	18
315/100	10207312-01	8100222	49,80		21
315/125	10207312-0	8100224	51,64	•	4
315/160	10207312-5	8100226	52,95	•	4
315/200	10207312-1	8100228	55,57	•	14
315/250	10207312-2	8100230	66,42	•	12
315/315	10207313-1	8100232	82,92	•	8
400/100	102074010	8103173	75,53		
400/125	10207401-5	8103174	77,15		
400/160	102074016-1	8103175	78,77	•	10
400/200	102074020-0	8100234	80,36	•	9
400/250	10207402-0	8100236	87,05	•	6
400/315	10207404-1	8100238	96,93	•	6
500/100	110137029	8103176	92,52		
500/125	10207635-0	8103177	107,70		
500/160	10207635-1	8103178	107,70		
500/200	10207635-2	8103179	110,38		
500/250	10207635-3	8100242	117,04	•	2
500/315	10207636-3	8100244	121,89	•	2
630/100	110137037	8103180	124,68		
630/125	10207160-2	8103181	127,63		
630/160	10207160-3	8103182	138,15		
630/200	10207160-4	8103183	144,28		
630/250	10207504-7	8103184	151,64		
630/315	10207503-9	8100250	156,92		
800/250	110137044	8103185	289,52		
800/315	10207315-4	8103186	295,24		

NORDduct - Pyöreä kanavajärjestelmä, galvanoitu
Imukartio suojaverkolla
NK

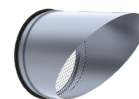

Koko ød	Tuotekoodi	LVI-koodi	Hinta €/kpl	kpl/laatikko
100	H10206100	8740100	58,39	• 20
125	H10206125	8740101	59,54	• 12
160	H10206160	8740102	59,97	• 6
200	H10206200	8740103	64,53	• 8
250	H10206250	8740104	67,70	• 8
315	H10206315	8740105	87,72	• 8
400	H10206400	8740106	96,89	• 16
500	H10206500	8740107	112,06	• 12
630	H10206630	8740108	138,82	• 7
800	H10206800	8740109	203,92	•
1000	H102061000	8740110	283,79	•
1250	H102061250	8740111	459,83	•

Viisto imupää verkolla
NP

Koko ød	Tuotekoodi	LVI-koodi	Hinta €/kpl	kpl/laatikko
100	10215010	8105882	51,96	
125	10215120	8105883	58,68	18
160	10215160	8105884	64,24	14
200	10215200	8105885	71,28	14
250	10215250	8105886	92,46	8
315	10215310	8105887	112,77	4
400	10215400	8105888	124,79	
500	10215500	8105889	161,43	
630	10215630	8105838	247,88	
800	10215800	8105839	327,29	
1000	102151000	8105840	406,59	
1250	102151250	8105841	528,38	

Imupää suojaverkolla
NG

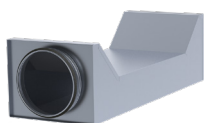
Koko ød	Tuotekoodi	LVI-koodi	Hinta €/kpl
100	8600201100	8105873	22,67
125	8600201125	8105874	26,97
160	8600201160	8105875	28,50
200	8600201200	8105876	31,26
250	8600201250	8105877	47,06
315	8600201315	8105878	54,78
400	8600201400	8105879	66,98
500	8600201500	8105880	79,86
630	8600201630	8105881	105,45
800	8600201800	8105827	151,13
1000	8600201900	8105828	211,57
1250	86002011250	8105829	291,95

Ristiinmenokappale
NTL

Koko Ød-L	Tuotekoodi	LVI-koodi	Hinta €/kpl	kpl/laatikko
100-500	8300000210	8105700	95,24	• 48
100-690	8300000217	8105701	101,57	• 36
125-500	830000025	8105702	99,23	• 40
125-690	8300000257	8105703	110,97	• 30
125-800	8300000258	8106105	123,07	• 24
160-600	8300000216	8105704	114,20	• 16
160-800	8300000218	8106106	125,01	• 14
160-900	8300000219	8105705	129,77	• 10
200-500	8300000221	8106103	157,81	
200-800	8300000220	8106102	161,97	
200-900	8300000222	8106104	179,55	

Saunakanava
TS

L=2400 mm

Koko ød	Tuotekoodi	LVI-koodi	Hinta €/kpl	kpl/laatikko
100-145x45	8610767646	8268370	81,02	• 50
125-170x45	8610767648	8268371	99,11	• 40

Ilmanvaihtokanavajärjestelmät

2. NORDdoor – Puhdistusluukut

Puhdistusluukku pyöreälle TL3



Koko øD	Tuotekoodi	LVI-koodi	Hinta €/kpl	kpl/laatikko
100	10114011-2	8318827	26,49	• 50
125	10114012-2	8318828	26,49	• 50
160	10114016-2	8318829	26,49	• 50
200	10113020-2	8318830	46,19	• 20
250	10114025-2	8318831	46,19	• 20
315	10114031-2	8318832	46,19	• 20
400	10114126-2	8318833	65,48	• 20
500	10115126-2	8318834	65,48	• 20
630	10116126-2	8318835	127,20	• 5
800	10116226-2	8318836	127,20	• 5
1000	10116227-2	8318837	127,20	• 5
1250	10116228-2	8318838	134,66	•

Puhdistusluukku, kanavaosa TLN3



Tuotekoodi	LVI-koodi	Hinta €/kpl	kpl/laatikko
10114011-4	8318839	95,74	6
10114012-4	8318840	98,31	9
10114016-4	8318841	100,91	5
10113020-4	8318842	113,85	3
10114025-4	8318843	135,83	3
10114031-4	8318844	138,43	2
10114126-4	8318845	182,41	4
10115126-4	8318846	203,11	
10116126-4	8318847	272,98	
10116226-4	8318597	364,84	
10116227-4	8318598	424,36	

Puhdistusluukku pyöreälle, paloeristetty (80 mm) TLPE-EI60



Aukko
100...160 – 200x100
200...500 – 400x200
630...1250 – 500x400

Tuotekoodi	LVI-koodi	Hinta €/kpl
10114020-12	8318557	204,23
10114012-11	8318558	204,23 •
10114016-11	8318559	204,23 •
10114020-11	8318560	287,86 •
10114020-14	8318561	287,86 •
10114031-11	8318562	287,86 •
10114126-11	8318563	287,86 •
10115126-0	8318564	287,86 •
10116127-4	8318565	388,73
10116226-9	8318566	427,83
10116227-5	8318567	427,76
10114126-12	8318568	533,33

Puhdistusluukku pyöreälle TPL

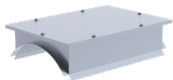

Aukko
200...315 – 200x100
400...500 – 300x200
630...800 – 400x300

Koko ød	Tuotekoodi	LVI-koodi	Hinta €/kpl
125			
160			
200	10114215-2	8318773	• 257,44
250	10114215-21	8318774	• 257,44
315	10114215-22	8318775	• 257,44
400	10114202-2	8318776	• 268,62
500	10114202-21	8318777	• 268,62
630	10114203-2	8318778	• 278,49
800	10114203-21	8318779	• 278,49

Puhdistusluukku pyöreälle, paloeristetty (80 mm) TPLE EI60

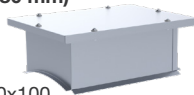

Aukko
125...315 – 200x100
400...500 – 300x200
630...800 – 400x300

Tuotekoodi	LVI-koodi	Hinta €/kpl
10114215-4	8318548	163,36 •
10114215-16	8318549	163,36 •
10114215-3	8318550	163,36 •
10114215-31	8318551	163,36 •
10114215-32	8318552	163,36 •
10114202-3	8318553	174,65 •
10114202-31	8318554	174,65 •
10114203-3	8318555	198,24 •
10114203-31	8318556	198,24

Puhdistusluukku tasopinnalle TL1



Koko Ax B	Tuotekoodi	LVI-koodi	Hinta €/kpl	kpl/laatikko
300x200	10113002-2	8318732	86,25	• 25
400x200	10114202-4	8318733	95,95	• 20
500x400	10114203-4	8318734	149,93	• 7

Puhdistusluukku tasopinnalle TLT

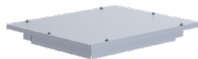

Koko Ax B	Tuotekoodi	LVI-koodi	Hinta €/kpl
300x200	10113002	8318590	187,52
300x300	10113003	8318591	187,52
400x100	10114201	8318592	187,52
400x200	10114202	8318569	187,52
500x200	10114205	8318593	205,13
500x400	10114203	8318570	205,13
600x300	10114207	8318594	217,25
600x400	10114206	8318595	231,07
600x500	10114204	8318596	231,07

Puhdistusluukku tasopinnalle, lämpö- tai paloeristetty TLTE

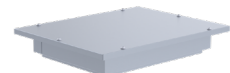

EI30 (60 mm)
EI60 (100 mm)

Koko Ax B	Tuotekoodi	LVI-koodi	Hinta €/kpl
200x100-EI30	10114215-30	8318780	193,91
400x200-EI30	10114202-30	8318781	199,95
400x300-EI30	10114203-30	8318782	227,84
500x400-EI30	10114204-30	8318783	252,09
200x100-EI60	10114215-60	8318784	196,93
400x200-EI60	10114202-60	8318785	252,09
400x300 EI60	10114203-60	8318786	237,54
500x400 EI60	10114204-60	8318787	327,22
200x100-LE 50	10114215-50	8318788	252,09
400x200-LE 50	1011442050	8318789	246,51
400x300-LE 50	10114203-50	8318790	259,35
500x400-LE 50	10114204-50	8318791	308,45

3. NORDdamper – Sääto- ja sulkupellit

Säätopeleti KRI



Koko- ød	Tuote- koodi	LVI-koodi	Hinta €/kpl	kpl/ laatikko
100	6200100A	8416700	33,38	• 252
125	6200125A	8416701	39,32	• 175
160	6200160A	8416702	55,62	• 112
200	6200200A	8416703	60,28	• 112
250	6200250A	8416704	88,57	• 54
315	6200315A	8416705	112,05	• 32
400	6200400A	8417161	215,98	• 24
500	6200500A	8417162	339,45	• 14
630	6200630A	8417163	513,75	• 6
800	6200800A	8417164	1100,90	• 4

Säätopeleti KROS



Tuote- koodi	LVI-koodi	Hinta €/kpl	kpl/ laatikko
6210100	8406466	30,42	• 60
6210125	8406467	31,90	• 30
6210160	8406468	33,77	• 20
6210200	8406469	37,05	• 23
6210250	8406470	48,04	• 45
6210315	8406471	56,03	• 25
6210400	8406472	113,83	• 24
6210500	8406473	138,51	• 6
6210630	8417151	160,66	• 6

Sääto- ja sulkupeliti, tiivistetty KRTS-4



Tuote- koodi	LVI-koodi	Hinta €/kpl	kpl/ laatikko
6210100-3	8417152	74,38	• 12
6210125-3	8417153	77,31	• 30
6210160-3	8417154	79,73	• 15
6210200-3	8417155	84,79	• 15
6210250-3	8417156	94,42	• 6
6210315-3	8417157	102,76	• 21
6210400-3	8417158	117,79	• 18
6210500-3	8417159	142,34	• 8
6210630-3	8417160	164,49	

Vyöhykepeleti KRTM



Koko- ød	Tuote- koodi	LVI-koodi	Hinta €/kpl
100-24V	110305001	8926282	397,41
125-24V	110305002	8926283	397,41
160-24V	110305003	8926284	401,02
100-230V	110305020	8926285	400,43
125-230V	110305021	8926286	400,43
160-230V	110305022	8926287	404,05

Vakiovirtaussäädin, pyöreä RPM-K



Ilmamäärän säätölaite RPM-V



Ilmavirtasäädin RPM-LV



Hinnat tarjouksen mukaan.

Vakiovirtaussäädin, suorakaide RPMC-K



Ilmamäärän säätölaite RPMC-V



Säätopeleti KR2

Sisältää käsiasäätökahvan

Mitat: leveys x korkeus

Varustettavissa yhdellä tai kahdella pyöreällä liitännällä. Hinnat tarjouksen mukaan.



Korkeus	Leveys												
	200	300	400	500	600	800	1000	1200	1400	1600	1800	2000	
200	193,69	195,69	198,61	200,59	203,53	208,45	253,74	258,64	250,30	263,47	310,21	337,96	
300	199,66	202,59	205,52	208,45	237,27	250,80	264,50	275,87	303,96	303,96	341,16	418,92	
400	210,63	204,47	224,10	249,76	254,67	260,53	278,13	299,02	323,10	323,10	369,71	437,98	
500	252,68	255,61	259,59	263,47	267,43	275,26	311,43	350,40	359,08	369,63	416,89	496,42	
600	263,88	257,60	270,40	266,49	283,99	307,18	340,23	375,64	388,44	388,44	467,08	505,37	
700	276,06	269,43	285,31	293,22	298,38	339,29	356,96	440,03	430,48	450,99	511,32	557,46	
800	285,15	298,42	312,26	309,36	331,24	357,56	364,44	455,91	442,29	463,97	556,51	609,64	
1000	333,96	337,30	377,46	366,56	391,51	409,91	451,66	512,47	611,88	566,00	588,00	695,08	
1200	394,62	420,07	429,49	457,24	471,65	502,66	532,94	624,25	655,18	685,53	714,91	831,80	
1400	471,34	488,39	505,46	523,30	539,63	574,53	608,56	706,33	741,24	798,54	793,92	912,78	
1600	515,57	534,60	553,50	573,25	591,43	630,07	667,93	771,85	782,32	871,67	871,81	1003,79	
1800	565,69	586,48	607,36	629,13	648,88	691,52	733,20	866,34	897,86	895,53	992,86	1106,50	
2000	681,40	704,74	728,34	752,79	775,26	823,14	893,28	1011,12	1027,87	1123,57	1106,50	1223,29	

Ilmanvaihtokanavajärjestelmät

NORDdamper - Sääto- ja sulkupellit

Sääto- ja sulkupelti, tiivistetty KR4

Mitat: leveys x korkeus

Varustettavissa yhdellä tai kahdella pyöreällä liitännällä. Hinnat tarjouksen mukaan.



Korkeus	Leveys											
	200	300	400	500	600	800	1000	1200	1400	1600	1800	2000
200	210,15	212,03	226,12	229,05	231,15	235,95	260,61	294,20	314,78	340,66	368,56	470,05
300	226,12	229,05	233,02	235,95	272,35	278,30	284,17	349,62	375,64	402,27	428,81	538,04
400	265,96	278,62	277,10	285,96	297,40	309,28	331,70	410,29	428,56	509,43	527,61	619,00
500	287,07	291,12	300,92	308,78	318,74	349,62	381,79	463,77	485,84	569,83	591,67	687,05
600	321,23	349,26	360,18	371,90	383,13	406,24	428,80	509,76	549,11	641,55	664,27	761,96
700	360,18	373,33	386,15	399,38	412,46	438,92	449,22	563,29	606,33	701,95	728,34	830,09
800	402,49	416,44	429,51	443,44	456,99	484,98	511,90	625,53	653,43	773,44	801,00	904,83
1000	473,09	489,35	504,73	520,99	536,85	569,52	617,40	730,87	763,55	911,44	943,57	1072,42
1200	561,08	579,80	597,34	615,89	633,99	687,60	723,87	876,85	914,24	1090,02	1145,24	1261,97
1400	641,87	662,98	682,51	703,79	740,43	782,76	823,39	992,97	1035,20	1257,45	1298,96	1422,08
1600	706,65	730,17	768,25	791,77	814,39	861,40	906,74	1092,65	1158,15	1389,56	1435,85	1581,44
1800	793,52	819,41	843,47	869,38	894,23	946,12	995,98	1216,49	1268,36	1527,58	1594,67	1730,47
2000	929,78	958,78	985,80	1014,80	1042,92	1100,77	1175,45	1395,39	1453,55	1758,34	1815,49	1896,76

Sääto- ja sulkupelti, tiivistetyt ja lämpöeristetyt säleät KR4 S

Mitat: leveys x korkeus

Varustettavissa yhdellä tai kahdella pyöreällä liitännällä. Hinnat tarjouksen mukaan.



Korkeus	Leveys											
	200	300	400	500	600	800	1000	1200	1400	1600	1800	2000
200	246,05	247,74	264,39	281,23	284,17	290,12	295,99	357,91	375,58	413,95	443,44	476,69
300	263,40	277,45	269,95	312,35	300,06	337,24	336,25	391,37	418,35	459,14	465,32	558,80
400	281,23	300,46	290,12	360,72	317,63	354,97	376,61	424,84	461,13	504,43	550,66	615,40
500	312,20	318,47	332,96	404,12	349,68	382,60	421,81	479,84	509,34	614,92	617,79	751,28
600	333,60	353,42	361,31	420,28	379,55	427,77	467,08	516,24	557,46	644,19	660,79	761,29
700	376,33	382,13	405,23	426,31	441,32	494,07	513,73	591,58	642,64	733,76	788,98	909,22
800	402,47	430,40	427,77	466,10	461,13	510,28	560,38	641,11	666,65	792,79	812,54	917,82
1000	498,59	503,40	527,83	531,93	561,61	590,93	653,89	746,44	771,86	918,31	984,22	1106,16
1200	592,14	609,09	602,91	642,07	640,07	700,11	764,01	905,30	941,57	1105,82	1192,93	1285,82
1400	678,53	681,42	699,98	755,12	744,35	810,14	874,14	1041,63	1065,44	1272,38	1361,48	1433,31
1600	723,76	780,10	767,88	795,49	846,53	913,47	987,20	1121,24	1200,74	1440,82	1493,71	1603,45
1800	818,99	841,18	863,26	904,57	946,94	1023,50	1093,37	1242,05	1296,80	1585,99	1659,12	1768,27
2000	983,16	980,17	1009,66	1045,79	1064,02	1130,70	1312,58	1434,17	1535,88	1884,81	1845,87	1929,65

Perhospelti RSKT



Koko Ød	Tuotekoodi	LVI-koodi	Hinta €/kpl	kpl/laatikko
100	10806100	8417370	22,01	• 30
125	10806125	8417371	23,01	• 25
160	10806160	8417372	26,91	• 25
200	10806200	8417373	33,67	• 10
250	10806250	8417374	43,88	• 8
315	10806315	8417375	49,11	•
400	10806316	8417376	119,35	•

Käsisäätökahva, 15x15 mm (pelleille KROS, KR)



Tuotekoodi	Hinta €/kpl	
6100000000	8417182	16,83

Käsisäätökahva, 8x8 mm (pelleille KRTS)



Tuotekoodi	Hinta €/kpl	
100700001	8406475	16,21

NORDdamper - Säätö- ja sulkupellit
**Säätö- ja sulkupelti
KRU**

Mitat: leveys x korkeus

Varustettavissa yhdellä tai kahdella pyöreällä liitännällä. Hinnat tarjouksen mukaan.



Korkeus	Leveys											
	200	300	400	500	600	800	1000	1200	1400	1600	1800	2000
200	319,74	330,69	341,08	351,76	362,43	383,77	405,25	481,68	503,44	561,21	608,32	742,78
300	355,45	368,56	381,79	395,44	408,81	435,71	462,47	566,48	593,52	656,85	709,63	850,36
400	431,45	445,96	459,76	474,42	488,50	517,53	546,27	648,44	677,33	805,11	833,85	978,29
500	466,88	483,95	500,73	517,81	535,04	569,33	603,33	732,96	767,83	900,45	935,03	1085,73
600	533,90	551,96	569,18	587,69	605,47	642,04	677,61	805,55	867,85	1013,86	1049,71	1204,11
700	569,18	589,96	610,31	631,23	651,72	693,56	734,97	890,21	958,23	1109,34	1150,89	1311,82
800	636,07	657,98	678,75	700,81	722,15	766,40	808,95	988,53	1032,64	1222,18	1265,72	1429,94
1000	747,62	773,37	797,71	823,32	848,51	900,02	975,59	1155,01	1206,52	1440,32	1491,11	1694,75
1200	886,79	916,24	943,99	973,30	1001,91	1086,71	1143,91	1385,68	1444,73	1722,63	1809,85	1994,27
1400	1014,28	1047,73	1078,60	1112,19	1170,11	1236,97	1301,15	1569,23	1635,97	1987,17	2052,90	2247,28
1600	1116,73	1153,88	1214,08	1251,21	1287,07	1361,35	1433,06	1726,76	1830,21	2196,05	2269,20	2499,28
1800	1254,05	1294,90	1333,02	1373,87	1413,14	1495,11	1573,95	1922,42	2004,53	2414,06	2520,20	2734,78
2000	1469,35	1515,16	1558,00	1603,68	1648,07	1739,57	1857,53	2205,16	2297,22	2778,75	2869,12	2997,47

**Säätö- ja sulkupelti
KRU-23**

Mitat: leveys x korkeus

Varustettavissa yhdellä tai kahdella pyöreällä liitännällä. Hinnat tarjouksen mukaan.



Korkeus	Leveys											
	200	300	400	500	600	800	1000	1200	1400	1600	1800	2000
200	412,23	444,11	475,55	507,14	538,88	601,92	665,24	783,63	847,09	946,84	1035,91	1212,08
300	483,81	520,24	556,66	593,80	630,24	703,80	776,93	927,48	1001,20	1111,04	1210,23	1397,63
400	573,03	609,31	645,03	681,17	717,17	789,75	861,88	1007,61	1080,04	1251,35	1323,50	1511,46
500	644,31	685,59	726,28	767,55	808,81	891,49	973,45	1151,32	1234,42	1415,28	1497,96	1697,02
600	724,43	764,98	804,97	845,96	886,37	968,18	1048,72	1221,90	1329,47	1520,43	1601,54	1801,18
700	795,58	841,25	886,51	932,33	977,86	1069,50	1160,70	1365,90	1483,57	1684,64	1776,14	1986,73
800	875,55	921,08	965,19	1010,59	1055,41	1146,34	1235,84	1462,37	1553,03	1789,51	1879,88	2090,91
1000	1036,20	1086,29	1134,81	1184,47	1233,99	1334,02	1458,24	1685,91	1786,11	2068,14	2167,31	2419,60
1200	1224,46	1278,82	1331,75	1386,11	1439,75	1574,79	1682,08	1973,93	2082,93	2411,06	2548,53	2782,88
1400	1400,91	1460,24	1517,03	1576,64	1660,46	1778,85	1894,95	2214,69	2333,23	2736,22	2853,60	3099,92
1600	1552,45	1616,34	1703,28	1767,04	1829,50	1957,28	2082,21	2429,41	2586,37	3008,86	3132,08	3415,68
1800	1738,71	1807,16	1872,76	1941,21	2008,08	2144,98	2278,86	2682,57	2819,45	3284,19	3445,41	3714,93
2000	2003,10	2077,24	2148,38	2222,52	2295,09	2443,52	2618,25	3022,22	3171,07	3709,52	3856,37	4041,64

**Säätö- ja sulkupelti
KRU-25**

Mitat: leveys x korkeus

Varustettavissa yhdellä tai kahdella pyöreällä liitännällä. Hinnat tarjouksen mukaan.



Korkeus	Leveys											
	200	300	400	500	600	800	1000	1200	1400	1600	1800	2000
200	290,06	300,48	310,64	320,80	331,22	351,67	372,26	442,00	462,85	515,96	559,53	681,12
300	335,92	350,53	365,15	380,14	394,87	424,60	454,08	552,54	582,53	644,66	697,38	828,62
400	397,67	412,15	426,00	440,35	454,59	483,43	511,89	606,16	634,87	751,88	780,47	912,35
500	443,28	462,21	480,63	499,57	518,36	556,23	593,70	716,56	754,81	880,46	918,31	1060,10
600	496,89	515,32	532,97	551,65	569,69	606,79	642,87	761,54	821,63	956,43	992,89	1135,19
700	542,51	565,38	587,73	610,73	633,47	679,34	724,94	872,20	941,45	1084,88	1130,75	1282,95
800	595,99	618,61	640,08	662,70	684,67	730,16	773,99	940,17	985,52	1160,73	1205,45	1357,91
1000	703,47	730,16	755,57	782,12	808,29	861,65	936,49	1104,19	1157,55	1373,54	1426,26	1615,44
1200	835,60	866,35	895,58	926,20	956,05	1040,67	1100,64	1325,26	1386,88	1643,77	1730,55	1904,10
1400	957,32	992,39	1025,04	1060,24	1117,15	1187,03	1254,87	1504,40	1574,28	1898,26	1967,12	2151,08
1600	1056,67	1095,68	1155,40	1194,40	1232,39	1310,40	1386,12	1660,16	1764,35	2105,22	2179,79	2397,05
1800	1187,15	1230,35	1270,89	1314,08	1355,75	1442,14	1525,74	1850,23	1936,63	2315,61	2423,61	2628,41
2000	1387,25	1435,53	1481,02	1529,30	1576,31	1672,74	1792,80	2117,80	2214,74	2659,54	2754,83	2884,17

Ilmanvaihtokanavajärjestelmät

4. NORDsmoke - Savunhallintajärjestelmät

NORDsmoke-savunhallintajärjestelmä sisältää kattavan valikoiman pyöreitä ja suorakaiteen muotoisia savunhallintakanavia ja -osia sekä savunhallintakanavan säätöpellit.

NORDsmoke-savunhallintajärjestelmä on sertifioitu yhden savunpoistolohkon savunhallintajärjestelmä. Järjestelmä on eurooppalaisen harmonisoidun standardin EN 12101-7 vaatimusten mukainen ja luokiteltu standardin EN 13501 mukaisesti.

Savunhallintakanavat on testattu 600°C lämpötilassa 2 tunnin ajan testausstandardin EN 1366-9 mukaisesti. Normaalityöntekijän maksimi käyttöpaine 1500 Pa.

Täydellinen valikoima tuotteista löytyy www.etsnord.fi/tuotteet > NORDsmoke

Suorakaide savunhallintajärjestelmän hinnat tarjouksen mukaan.



CE

Kierresaumakanava
Pituus 3 m, tulpattu
NTO-T-3

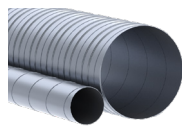

CE

Koko Dø	Tuotekoodi	LVI-koodi	Hinta €/m	m/ häkki
100	111701001	8132000	20,67	378
125	111701002	8132001	24,58	252
160	111701003	8132002	29,43	153
200	111701004	8132003	36,90	90
250	111701005	8132004	47,21	60
315	111701006	8132005	58,20	36
400	111701007	8132006	81,75	18
500	111701008	8132007	107,06	12
630	111701009	8132008	124,74	
800	111701010	8132009	153,86	
1000	111701011	8132010	201,45	

Kierresaumakanava
Pituus 6 m, tulpattu
NTO-T-6

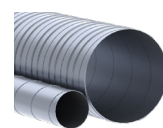

CE

Tuotekoodi	LVI-koodi	Hinta €/m	m/ häkki
111702001	8132012	20,67	756
111702002	8132013	24,58	504
111702003	8132014	29,43	306
111702004	8132015	36,90	180
111702005	8132016	47,21	120
111702006	8132017	58,20	72
111702007	8132018	81,75	36
111702008	8132019	107,06	24
111702009	8132020	124,74	
111702010	8132021	153,86	
111702011	8132022	201,45	

Käyrä
NV-T 90°



Koko dø	Tuotekoodi	LVI-koodi	Hinta €/kpl
100	111703001	8132024	42,10
125	111703002	8132025	43,67
160	111703003	8132026	46,22
200	111703004	8132027	49,54
250	111703005	8132028	56,16
315	111703006	8132029	64,27
400	111703007	8132030	105,36
500	111703008	8132031	130,17
630	111703009	8132032	166,39
800	111703010	8132033	248,77
1000	111703011	8132034	586,38

Käyrä
NV-T 60°



Tuotekoodi	LVI-koodi	Hinta €/kpl
111704001	8132036	41,26
111704002	8132037	42,81
111704003	8132038	45,32
111704004	8132039	48,55
111704005	8132040	52,62
111704006	8132041	59,10
111704007	8132042	94,86
111704008	8132043	117,89
111704009	8132044	145,45
111704010	8132045	216,89
111704011	8132046	559,47

Käyrä
NV-T 45°



Tuotekoodi	LVI-koodi	Hinta €/kpl
111705001	8132047	37,54
111705002	8132048	38,92
111705003	8132049	41,35
111705004	8132050	44,03
111705005	8132051	47,12
111705006	8132052	51,17
111705007	8132053	82,70
111705008	8132054	100,14
111705009	8132055	124,87
111705010	8132056	186,97
111705011	8132057	549,83

**Käyrä
NV-T 30°**

Koko d _ø	Tuotekoodi	LVI-koodi	Hinta €/kpl
250	111706005	8132063	46,78
315	111706006	8132064	50,83
400	111706007	8132065	79,87
500	111706008	8132066	97,15
630	111706009	8132067	120,66
800	111706010	8132068	178,63
1000	111706011	8132069	369,24

**Käyrä
NV-T 15°**

Tuotekoodi	LVI-koodi	Hinta €/kpl
111707005	8132074	49,09
111707006	8132075	49,36
111707007	8132076	79,56
111707008	8132077	89,35
111707009	8132078	101,51
111707010	8132079	140,44
111707011	8132080	298,22

**Sisäliitin
NI-T**

Koko d _ø	Tuotekoodi	LVI-koodi	Hinta €/kpl
100	111708001	8132081	11,67
125	111708002	8132082	12,66
160	111708003	8132083	14,35
200	111708004	8132084	16,06
250	111708005	8132085	19,05
315	111708006	8132086	22,22
400	111708007	8132087	29,36
500	111708008	8132088	36,81
630	111708009	8132089	42,66
800	111708010	8132090	66,48
1000	111708011	8132091	90,56

**Pitkä sisäliitin
NIL-T**

Tuotekoodi	LVI-koodi	Hinta €/kpl
111709001	8132093	12,57
111709002	8132094	13,70
111709003	8132095	15,72
111709004	8132096	17,68
111709005	8132097	21,40
111709006	8132098	25,63
111709007	8132099	34,14
111709008	8132100	43,13
111709009	8132101	53,51
111709010	8132102	82,96
111709011	8132103	114,56

**Ulkoliitin
NM-T**

Tuotekoodi	LVI-koodi	Hinta €/kpl
111712001	8132105	5,28
111712002	8132106	5,51
111712003	8132107	6,17
111712004	8132108	6,99
111712005	8132109	8,02
111712006	8132110	9,08
111712007	8132111	12,32
111712008	8132112	17,84
111712009	8132113	20,18
111712010	8132114	31,46
111712011	8132115	48,73

**Lähtökaulus
tasopinnalle, jyrkkä
NSK-T**

Koko Ød	Tuotekoodi	LVI-koodi	Hinta €/kpl
100	111713001	8132116	21,90
125	111713002	8132117	22,29
160	111713003	8132118	23,11
200	111713004	8132119	24,08
250	111713005	8132120	26,84
315	111713006	8132121	28,38
400	111713007	8132122	46,05
500	111713008	8132123	49,71
630	111713009	8132124	55,23
800	111713010	8132125	82,62
1000	111713011	8132126	95,02

**Lähtökaulus
tasopinnalle, osalle
NSKM-T**

Tuotekoodi	LVI-koodi	Hinta €/kpl
111714001	8132127	7,55
111714002	8132128	7,86
111714003	8132129	8,11
111714004	8132130	8,60
111714005	8132131	8,20
111714006	8132132	8,76
111714007	8132133	10,55
111714008	8132134	12,16
111714009	8132135	14,03
111714010	8132136	39,57
111714011	8132137	58,46

**Tulppa kanavalle
NAL-T**

Tuotekoodi	LVI-koodi	Hinta €/kpl
111715001	8132138	24,75
111715002	8132139	25,79
111715003	8132140	26,30
111715004	8132141	26,71
111715005	8132142	27,98
111715006	8132143	30,56
111715007	8132144	48,50
111715008	8132145	53,42
111715009	8132146	62,35
111715010	8132147	93,00
111715011	8132148	110,52

Ilmanvaihtokanavajärjestelmät

NORDsmoke - Pyöreä savunhallintakanavajärjestelmä, galvanoitu

Tulppa kanavalle NALM-T



Koko Ød	Tuotekoodi	LVI-koodi	Hinta €/kpl
100	111716001	8132150	8,84
125	111716002	8132151	9,17
160	111716003	8132152	9,58
200	111716004	8132153	10,70
250	111716005	8132154	11,59
315	111716006	8132155	12,57
400	111716007	8132156	16,31
500	111716008	8132157	21,25
630	111716009	8132158	31,21
800	111716010	8132159	48,08
1000	111716011	8132160	79,45

Tulppa-puhdistusluukku kanavalle NALH-T



Tuotekoodi	LVI-koodi	Hinta €/kpl
111717001	8132161	35,12
111717002	8132162	35,84
111717003	8132163	36,20
111717004	8132164	36,53
111717005	8132165	37,95
111717006	8132166	42,32
111717007	8132167	60,17
111717008	8132168	65,12
111717009	8132169	74,85
111717010	8132170	106,37
111717011	8132171	125,12

Tulppa-puhdistusluukku osalle NALMH-T



Tuotekoodi	LVI-koodi	Hinta €/kpl
111718001	8132172	14,59
111718002	8132173	15,01
111718003	8132174	15,41
111718004	8132175	16,45
111718005	8132176	17,52
111718006	8132177	23,20
111718007	8132178	26,91
111718008	8132179	31,94
111718009	8132180	42,57
111718010	8132181	60,17
111718011	8132182	92,75

Muunto, keskeinen osa/osa NFCV-T



Koko Ød1-d2	Tuotekoodi	LVI-koodi	Hinta €/kpl
125/100	111719001	8132183	47,34
160/100	111719002	8132184	48,73
160/125	111719005	8132187	51,17
200/100	111719003	8132185	51,13
200/125	111719006	8132188	53,68
200/160	111719009	8132191	51,98
250/100	111719004	8132186	54,20
250/125	111719007	8132189	56,92
250/160	111719010	8132192	56,92
250/200	111719013	8132195	57,38
315/125	111719008	8132190	58,07
315/160	111719011	8132193	59,70
315/200	111719014	8132196	61,86
315/250	111719017	8132199	63,40
400/125	MP00409	8132496	83,93
400/160	111719012	8132194	83,93
400/200	111719015	8132197	85,42
400/250	111719018	8132200	86,49
400/315	111719021	8132203	87,56
500/200	111719016	8132198	97,15
500/250	111719019	8132201	103,87
500/315	111719022	8132204	98,93
500/400	111719025	8132207	112,97
630/250	111719020	8132202	107,63
630/315	111719023	8132205	110,81
630/400	111719026	8132208	129,96
630/500	111719029	8132211	135,44
800/315	111719024	8132206	150,49
800/400	111719027	8132209	173,67
800/500	111719030	8132212	180,85
800/630	111719032	8132214	189,88
1000/400	111719028	8132210	207,73
1000/500	111719031	8132213	216,99
1000/630	111719033	8132215	224,25
1000/800	111719034	8132216	234,06

Muunto, keskeinen kanava/osa NFCVM-T



Koko Ød1-d2	Tuotekoodi	LVI-koodi	Hinta €/kpl
125/100	111720001	8132217	32,52
160/100	111720002	8132218	33,36
160/125	111720005	8132221	35,02
200/100	111720003	8132219	35,13
200/125	111720006	8132222	36,88
200/160	111720009	8132225	35,52
250/100	111720004	8132220	35,91
250/125	111720007	8132223	37,70
250/160	111720010	8132226	36,59
250/200	111720013	8132229	38,92
315/125	111720008	8132224	38,68
315/160	111720011	8132227	42,01
315/200	111720014	8132230	43,62
315/250	111720017	8132233	44,49
400/160	111720012	8132228	48,73
400/200	111720015	8132231	50,67
400/250	111720018	8132234	51,73
400/315	111720021	8132237	54,33
500/200	111720016	8132232	59,93
500/250	111720019	8132235	60,92
500/315	111720022	8132238	61,86
500/400	111720025	8132241	76,22
630/250	111720020	8132236	68,20
630/315	111720023	8132239	72,35
630/400	111720026	8132242	89,96
630/500	111720029	8132245	99,61
800/315	111720024	8132240	91,12
800/400	111720027	8132243	123,94
800/500	111720030	8132246	131,89
800/630	111720032	8132248	138,50
1000/400	111720028	8132244	148,74
1000/500	111720031	8132247	156,68
1000/630	111720033	8132249	164,33
1000/800	111720034	8132250	171,28

Muunto, epäkeskeinen kanava/osa NFBM-T



Koko ØD-d2	Tuotekoodi	LVI-koodi	Hinta €/kpl
125/100	111722001	8132285	31,19
160/100	111722002	8132286	31,95
160/125	111722005	8132289	33,57
200/100	111722003	8132287	33,21
200/125	111722006	8132290	34,87
200/160	111722009	8132293	33,29
250/100	111722004	8132288	34,36
250/125	111722007	8132291	36,09
250/160	111722010	8132294	36,09
250/200	111722013	8132297	35,52
315/125	111722008	8132292	36,00
315/160	111722011	8132295	36,99
315/200	111722014	8132298	38,84
315/250	111722017	8132301	40,01
400/160	111722012	8132296	45,86
400/200	111722015	8132299	47,10
400/250	111722018	8132302	48,04
400/315	111722021	8132305	48,42
500/200	111722016	8132300	56,75
500/250	111722019	8132303	57,99
500/315	111722022	8132306	60,91
500/400	111722025	8132309	72,07
630/250	111722020	8132304	72,07
630/315	111722023	8132307	68,64
630/400	111722026	8132310	83,93
630/500	111722029	8132313	85,80
800/315	111722024	8132308	89,43
800/400	111722027	8132311	109,50
800/500	111722030	8132314	111,57
800/630	111722032	8132316	110,28
1000/400	111722028	8132312	147,35
1000/500	111722031	8132315	149,81
1000/630	111722033	8132317	157,15
1000/800	111722034	8132318	167,81

NORDsmoke - Pyöreä savunhallintakanavajärjestelmä, galvanoitu
**Muunto, epäkeskeinen
osa/osa
NFB-T**

Koko Ød1-d2	Tuotekoodi	LVI-koodi	Hinta €/kpl	Koko Ød1-d2	Tuotekoodi	LVI-koodi	Hinta €/kpl	Koko Ød1-d2	Tuotekoodi	LVI-koodi	Hinta €/kpl
125/100	111721001	8132251	45,65	315/200	111721014	8132264	67,21	630/315	111721023	8132273	111,66
160/100	111721002	8132252	47,03	315/250	111721017	8132267	64,01	630/400	111721026	8132276	126,73
160/125	111721005	8132255	49,37	400/125	MP00408	8132497	86,49	630/500	111721029	8132279	133,06
200/100	111721003	8132253	48,89	400/160	111721012	8132262	86,49	800/315	111721024	8132274	151,12
200/125	111721006	8132256	51,33	400/200	111721015	8132265	86,64	800/400	111721027	8132277	168,35
200/160	111721009	8132259	54,82	400/250	111721018	8132268	87,35	800/500	111721030	8132280	169,80
250/100	111721004	8132254	52,43	400/315	111721021	8132271	91,72	800/630	111721032	8132282	178,29
250/125	111721007	8132257	57,29	500/200	111721016	8132266	98,22	1000/400	111721028	8132278	209,50
250/160	111721010	8132260	57,76	500/250	111721019	8132269	98,99	1000/500	111721031	8132281	219,97
250/200	111721013	8132263	59,08	500/315	111721022	8132272	103,95	1000/630	111721033	8132283	214,05
315/125	111721008	8132258	61,01	500/400	111721025	8132275	111,57	1000/800	111721034	8132284	224,25
315/160	111721011	8132261	61,77	630/250	111721020	8132270	117,25				

**Lähtökaulus, lyhyt kaulus
NPSK-T**

Koko Ød1-d2	Tuotekoodi	LVI-koodi	Hinta €/kpl	Koko Ød1-d2	Tuotekoodi	LVI-koodi	Hinta €/kpl	Koko Ød1-d2	Tuotekoodi	LVI-koodi	Hinta €/kpl
100/100	111723001	8132319	33,81	500/315	111723024	8132342	51,89	100/100	111725001	8132375	64,86
125/100	111723002	8132320	36,81	500/400	111723025	8132343	73,54	125/100	111725002	8132376	70,22
125/125	111723003	8132321	35,36	500/500	111723026	8132344	85,46	125/125	111725003	8132377	71,31
160/100	111723004	8132322	37,86	630/315	111723027	8132345	53,11	160/100	111725004	8132378	74,03
160/125	111723005	8132323	39,57	630/400	111723028	8132346	73,88	160/125	111725005	8132379	75,81
160/160	111723006	8132324	40,76	630/500	111723029	8132347	81,73	160/160	111725006	8132380	77,03
200/100	111723007	8132325	41,68	630/630	111723030	8132348	99,83	200/100	111725007	8132381	82,96
200/125	111723008	8132326	39,65	800/315	111723041	8132359	55,54	200/125	111725008	8132382	80,68
200/160	111723009	8132327	39,32	800/400	111723031	8132349	74,59	200/160	111725009	8132383	82,05
200/200	111723010	8132328	41,51	800/500	111723032	8132350	82,05	200/200	111725010	8132384	85,14
250/125	111723011	8132329	39,65	800/630	111723033	8132351	92,93	250/125	111725011	8132385	90,16
250/160	111723012	8132330	40,04	800/800	111723034	8132352	140,68	250/160	111725012	8132386	91,63
250/200	111723013	8132331	40,70	1000/500	111723035	8132353	84,82	250/200	111725013	8132387	93,90
250/250	111723014	8132332	44,34	1000/630	111723036	8132354	95,42	250/250	111725014	8132388	99,08
315/160	111723015	8132333	39,65	1000/800	111723037	8132355	135,25	315/160	111725015	8132389	98,76
315/200	111723016	8132334	41,60	1000/1000	111723038	8132356	247,14	315/200	111725016	8132390	102,32
315/250	111723017	8132335	44,92					315/250	111725017	8132391	107,52
315/315	111723018	8132336	49,78					315/315	111725018	8132392	113,67
400/100	111723039	8132357	42,81					400/200	111725019	8132393	130,05
400/125	111723042	8132360	40,78					400/250	111725020	8132394	135,64
400/160	111723040	8132358	41,60					400/315	111725021	8132395	141,33
400/200	111723019	8132337	43,87					500/250	111725023	8132397	151,30
400/250	111723020	8132338	47,12					500/315	111725024	8132398	156,89
400/315	111723021	8132339	51,08					500/250	111725023	8132397	151,30
400/400	111723022	8132340	75,08					500/315	111725024	8132398	156,89
500/250	111723023	8132341	48,50					630/315	111725027	8132401	173,43

**T-yhde
NTK-T**

Ilmanvaihtokanavajärjestelmät

NORDsmoke - Pyöreä savunhallintakanavajärjestelmä, galvanoitu

Lähtökaulus
NPSV-T

Koko ØD-d2	Tuotekoodi	LVI-koodi	Hinta €/kpl
400/400	111724001	8132361	74,59
500/400	111724002	8132362	77,68
500/500	111724005	8132365	88,86
630/400	111724003	8132363	79,22
630/500	111724006	8132366	90,73
630/630	111724009	8132369	109,96
800/400	111724004	8132364	78,15
800/500	111724007	8132367	93,24
800/630	111724010	8132370	116,03
800/800	111724012	8132372	159,89
1000/500	111724008	8132368	115,21
1000/630	111724011	8132371	129,57
1000/800	111724013	8132373	182,35
1000/1000	111724014	8132374	236,92

T-yhde
NTKV-T

Koko ØD-d2	Tuotekoodi	LVI-koodi	Hinta €/kpl
400/400	111726001	8132413	126,81
500/400	111726002	8132414	138,73
500/500	111726003	8132415	153,74
630/400	111726004	8132416	154,30
630/500	111726005	8132417	168,41
630/630	111726006	8132418	194,69
800/400	111726007	8132419	186,49
800/500	111726008	8132420	214,87
800/630	111726009	8132421	239,20
800/800	111726010	8132422	298,30
1000/500	111726011	8132423	295,95
1000/630	111726012	8132424	327,82
1000/800	111726013	8132425	400,22
1000/1000	111726014	8132426	512,84

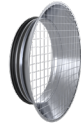
Imukartio suojaverkolla
NK-T

Koko ød	Tuotekoodi	LVI-koodi	Hinta €/kpl
100	111745001	8132472	25,22
125	111745002	8132473	28,63
160	111745003	8132474	32,02
200	111745004	8132475	38,67
250	111745005	8132476	44,60
315	111745006	8132477	52,06
400	111745007	8132478	63,49
500	111745008	8132479	77,68
630	111745009	8132480	95,28
800	111745010	8132481	132,66
1000	111745011	8132482	183,80

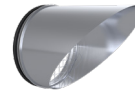
Viisto imupää verkolla
NP-T

Tuotekoodi	LVI-koodi	Hinta €/kpl
111746001	8132483	34,71
111746002	8132484	45,32
111746003	8132485	47,85
111746004	8132486	50,68
111746005	8132487	68,11
111746006	8132488	74,44
111746007	8132489	92,84
111746008	8132490	116,36
111746009	8132491	155,19
111746010	8132492	216,24
111746011	8132493	333,33

Imupää suojaverkolla
NG-T

Tuotekoodi	LVI-koodi	Hinta €/kpl
111744001	8132461	18,80
111744002	8132462	22,05
111744003	8132463	23,77
111744004	8132464	25,70
111744005	8132465	31,94
111744006	8132466	36,09
111744007	8132467	43,95
111744008	8132468	54,07
111744009	8132469	70,38
111744010	8132470	97,46
111744011	8132471	137,11

NORDsmoke - Pyöreä savunhallintakanavajärjestelmä, galvanoitu

**Säätöpelti
KRI-T**



**Poistoilmasäleikkö
(kiinnityскеyksellä)
RSN-T**

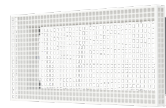

**Savunhallintakanavan säätöpelti
KR2-T**



Koko ød	Tuote-koodi	LVI-koodi	Hinta €/kpl
100	111748001	8417377	76,66
125	111748002	8417378	83,11
160	111748003	8417379	106,39
200	111748004	8417380	114,07
250	111748005	8417381	163,96
315	111748006	8417382	193,07
400	111748007	8417383	395,98
500	111748008	8417384	573,41
630	111748009	8417385	829,16
800	111748010	8417386	1618,70

Koko BxH	Tuote-koodi	LVI-koodi	Hinta €/kpl
200x100	120111001	8741211	132,36
200x150	120111002	8741212	137,42
300x100	120111003	8741213	139,30
300x150	120111004	8741214	145,68
300x200	120111005	8741215	151,82
400x100	120111006	8741216	146,83
400x150	120111007	8741217	154,34
400x200	120111008	8741218	160,88
500x150	120111009	8741219	162,35
500x200	120111010	8741220	170,67
600x150	120111011	8741221	171,34
600x200	120111012	8741222	180,40
800x150	120111013	8741223	190,72
800x200	120111014	8741224	199,78
1000x20	120111015	8741225	221,96

Hinnat tarjouksen mukaan.

**Savunhallintakanavan sulkupelti
KRS-T**

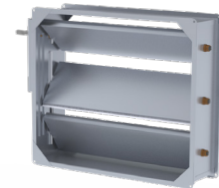

Hinnat tarjouksen mukaan.

**Savunhallintapelti
SEDS-L**



Yhden osaston savunhallintapelti. Varustettu sähköisellä toimilaitteella. Paloluokka E₆₀₀ 120. Testattu standardin EN 1366-10 mukaan. Hinnat tarjouksen mukaan.



**Savunhallintapelti
SEDS-R**



Yhden osaston savunhallintapelti. Varustettu sähköisellä toimilaitteella. Paloluokka E₆₀₀ 120. Testattu standardin EN 1366-10 mukaan. Hinnat tarjouksen mukaan.



**Savunhallintapelti
SEDM**

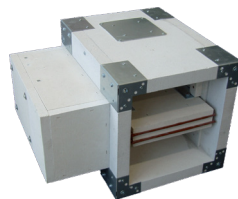

Usean osaston savunhallintapelti. Paloluokka EIS120. Hinnat tarjouksen mukaan.



**Savunhallintapelti
SEDM-L**



Usean osaston savunhallintapelti. Paloluokka EIS120. Hinnat tarjouksen mukaan.



Ilmanvaihtokanavajärjestelmät

5. NORDfire – Palotuotteet

MANDIK®

Kauluspalopelti mikrokytkimillä
FDMS .80



Paloluokka EIS90 / EIS60

Koko Ød	Tuotekoodi	LVI-koodi	Hinta €/kpl
100	110422021	8432165	239,69
125	110422022	8432166	242,50
160	110422023	8432167	259,98
200	110422024	8432168	284,73
250	110422025	8432169	330,05
315	110422026	8432170	373,07
400	110422027	8432171	471,90
500	110422028	8432172	565,56
630	110422029	8432173	664,76

Kauluspalopelti 24V toimilaitteella
FDMS .50



Paloluokka EIS90/EIS120

Koko Ød	Tuotekoodi	LVI-koodi	Hinta €/kpl
100	110422041	8432183	704,34
125	110422042	8432184	709,14
160	110422043	8432185	713,67
200	110422044	8432186	737,85
250	110422045	8432187	761,26
315	110422046	8432188	783,33
400	110422047	8432189	817,53
500	110422048	8432190	931,27
630	110422049	8432191	1073,65

Palopelti mikrokytkimillä
FDMR .80 100-800
FDMA-R .80 1000



Paloluokka EIS90/EIS120
72 °C sulakelaukaisu



Koko Ød	Tuotekoodi	LVI-koodi	Hinta €/kpl
100	110423120	8433024	346,49
125	110423121	8433025	354,20
160	110423122	8433026	368,54
200	110423123	8433027	359,98
250	110423124	8433028	392,47
315	110423125	8433029	433,08
400	110423126	8433030	527,27
500	110423127	8433031	617,88
630	110423128	8433032	738,17
800	110423129	8433033	1202,42
1000	110419634	8433370	1842,72

Palopelti toimilaitteella
FDMR .50 100-800
FDMA-R .50 1000



Paloluokka EIS90/EIS120
72 °C sulakelaukaisu



Koko Ød	Tuotekoodi	LVI-koodi	Hinta €/kpl
100	110423140	8433044	772,08
125	110423141	8433045	773,56
160	110423142	8433046	795,95
200	110423143	8433047	859,79
250	110423144	8433048	894,75
315	110423145	8433049	938,66
400	110423146	8433050	1013,01
500	110423147	8433051	1110,75
630	110423148	8433052	1373,23
800	110423149	8433053	1733,57
1000	110420724	8432146	2275,24

Palopelti FDMA



Paloluokka EI120 ATEX
Hinnat tarjouksen mukaan.

Palopelti FDMB



Paloluokka EI120
Hinnat tarjouksen mukaan.

Palonrajoitin DM-S



Paloluokka ES30
Hinnat tarjouksen mukaan.

6. ETScontrol -palopeltien ohjaus- ja valvontajärjestelmä

ETS Control on BACnet- ja Modbus-väyläpohjainen palopeltien ohjaus- ja valvontajärjestelmä. Järjestelmän käyttö tapahtuu joko suoraan graafiselta käyttöpaneelilta tai internetin kautta. Järjestelmä koostuu kommunikointimoduuleista (BIO) sekä keskusyksiköstä (BRP). Yhteen keskusyksikköön voidaan liittää jopa 99 kpl BIO-kommunikointimoduuleja. Järjestelmän käyttö tapahtuu joko graafisen käyttöpaneelin, wifi-verkon tai internetin kautta millä tahansa selainpohjaisella laitteella (tietokone, tabletti, älypuhelin). Järjestelmän laajennus toteutetaan lisäämällä uusi prosessori master-slave-periaatteella, jolloin järjestelmää voidaan laajentaa käytännössä rajattomasti. Järjestelmän kommunikointiprotokollat ovat joko BACnet tai Modbus, joten se on erittäin helppo integroida osaksi kiinteistön automaatiojärjestelmää.

Hinnat tarjouksen mukaan.
Lisätietoja ETS Controllista löydät www.etsnord.fi/tuotteet > NORDfire



7. NORDsilencer - Äänenvaimentimet

Pyöreä äänenvaimennin,
lasikuituhuovalla suojattu mineraalivilla 50 mm
NRF 50



Koko-pituus Ød - L	Tuotekoodi	LVI-koodi	Hinta €-kpl
100-300	10211023	8324362	47,47 •
100-600	10211026	8324363	64,55 •
100-900	10211029	8324364	81,62 •
100-1200	10211022	8324365	140,66
125-300	10211123	8324366	61,14 •
125-600	10211126	8324367	71,94 •
125-900	10211129	8324368	90,12 •
125-1200	10211122	8324369	129,02
160-300	10211163	8324370	75,17
160-600	10211166	8324371	83,42 •
160-900	10211169	8324372	105,04 •
160-1200	10211162	8324373	129,87
200-300	10211203	8324374	85,65
200-600	10211206	8324375	96,27 •
200-900	10211209	8324376	124,30 •
200-1200	10211202	8324377	153,35
250-300	10211253	8324378	102,35
250-600	10211256	8324379	118,53 •
250-900	10211259	8324380	154,81 •
250-1200	10212252	8324381	238,67
315-600	10211316	8324383	145,50 •
315-900	10212319	8324384	189,21 •
315-1200	10212312	8324385	269,81
400-600	10211406	8324386	290,20
400-900	10211408	8324387	341,85
400-1200	10212412	8324388	383,25
500-600	102115060	8324389	304,70
500-900	1021159	8324390	365,76
500-1200	10211512	8324391	460,77

Pyöreä äänenvaimennin,
polyesterieriste 50 mm
NRP 50



Koko-pituus Ød - L	Tuotekoodi	LVI-koodi	Hinta €-kpl
100/300	10211023-1	8324239	76,95 •
100/600	10211026-1	8324240	78,93 •
100/900	10211029-1	8324241	95,64 •
100/1200	10211022-1	8324242	149,71
125/300	10211123-1	8324243	82,04 •
125/600	10211126-1	8324244	85,47 •
125/900	10211129-1	8324245	102,89 •
125/1200	10211122-1	8324246	165,51
160/300	10211163-1	8324247	94,74 •
160/600	10211166-1	8324248	98,26 •
160/900	10211169-1	8324249	117,54 •
160/1200	10211162-1	8324250	186,16
200/300	10211203-1	8324251	107,41
200/600	10211206-1	8324252	109,17 •
200/900	10211209-1	8324253	139,99 •
200/1200	10211202-1	8324254	211,30
250/600	10211256-1	8324256	132,99 •
250/900	10211259-1	8324257	172,46 •
250/1200	10212252-1	8324258	249,28 •
315/600	10211316-1	8324260	158,90 •
315/900	10212319-1	8324261	202,39 •
315/1200	10212312-1	8324262	291,47
400/600	10211406-1	8324264	299,01 •
400/900	10211408-1	8324265	352,08 •
400/1200	10212412-1	8324266	394,66
500/600	102115060-1	8324267	312,89 •
500/900	10211590-1	8324268	401,59 •
500/1200	10211512-1	8324269	495,13
630/900	10211639-1	8324270	469,44
630/1200	10211612-1	8324271	596,61
800/900	10211809-1	8324272	644,52
800/1200	10211812-1	8324273	869,85

Pyöreä äänenvaimennin,
lasikuituhuovalla suojattu
mineraalivilla 100 mm
NRF 100



Koko-pituus Ød - L	Tuotekoodi	LVI-koodi	Hinta €-kpl
100/900	10211100	8324400	151,02
125/900	10211127	8324404	164,95
125/1200	102111212	8324405	190,01
160/900	10211160	8324408	183,57
160/1200	102111612	8324409	213,76
200/600	102112060	8324411	170,57
200/900	102112090	8324412	206,60
200/1200	102112012	8324413	242,66
250/600	102112506	8324416	204,54
250/900	10211250	8324417	243,23
250/1200	10211252	8324418	290,34
315/600	102113160	8324421	224,60
315/900	10211319	8324422	249,72
315/1200	10211312	8324423	311,50

Koko-pituus Ød - L	Tuotekoodi	LVI-koodi	Hinta €-kpl
400/600	10211405	8324427	317,85
400/900	10211409	8324428	379,48
400/1200	10211412	8324429	458,91
500/600	10211506	8324433	343,66
500/900	10211509	8324434	431,14
500/1200	10211515	8324435	567,53
500/1500	10211512B	8324436	779,41
630/600	102116305	8324816	422,20
630/900	102116309	8324438	615,43
630/1200	10211632	8324439	663,31
800/900	10211805	8324443	959,74
800/1200	10211802	8324444	1033,71
1000/900	102111006	8324815	1331,00
1000/1200	102111002	8324447	1513,30

Ilmanvaihtokanavajärjestelmät

NORDsilencer – Äänenvaimentimet

**Pyöreä äänenvaimennin, polyesterieriste 100 mm
NRP 100**



Koko-pituus Ød - L	Tuotekoodi	LVI-koodi	Hinta €-kpl
100/600	110502400	8324286	138,64
100/900	10211100-1	8324287	158,41
125/600	10211125-1	8324288	157,40
125/900	10211127-1	8324289	174,11
160/600	110502404	8324290	163,63
160/900	10211160-1	8324291	195,48
160/1200	102111612-1	8324292	254,20
200/600	102112060-1	8324293	180,34
200/900	102112090-1	8324294	221,42
200/1200	102112012-1	8324295	262,37
250/600	102112506-1	8324296	208,19
250/900	10211250-1	8324297	261,59
250/1200	10211252-1	8324298	315,00
315/600	102113160-1	8324299	240,09
315/900	10211319-1	8324300	304,43
315/1200	10211312-1	8324301	368,66
400/600	10211405-1	8324302	327,29
400/900	10211409-1	8324274	390,91
400/1200	10211412-1	8324303	472,66
500/600	10211506-1	8324304	416,37
500/900	10211509-1	8324275	481,01
500/1200	10211515-1	8324305	584,54
630/900	102116309-1	8324306	633,85
630/1200	10211632-1	8324307	683,19
800/900	10211805-1	8324308	988,55
800/1200	10211802-1	8324309	1117,97
1000/1200	102111002-1	8324812	1441,24

**Pyöreä äänenvaimennin kasetilla, lasikuituhuovalla suojattu mineraalivilla 100 mm
NRFB 100**



Koko-pituus Ød - L	Tuotekoodi	LVI-koodi	Hinta €-kpl
315/600	10323160	8324310	409,57
315/900	10323190	8324311	457,45
315/1200	10211312B	8324312	548,94
400/600	10324060	8324455	534,32
400/900	10324090	8324313	565,71
400/1200	103240120	8324314	603,38
500/900	10211509B	8324315	608,04
500/1200	103250120	8324316	681,75
630/600	10326360	8324317	670,33
630/900	10326390	8324318	1025,31
630/1200	10211632B	8324319	1087,06
800/900	10328090	8324320	1006,71
800/1200	10211802B	8324321	1389,21

**Avattava äänenvaimennin, suorakaide-pyöreät liittokset, lasikuituhuovalla suojattu mineraalivilla
NTFA**

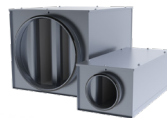

Koko-pituus Ød - L	Tuotekoodi	LVI-koodi	Hinta €-kpl
100/300	110516030	8324864	122,84
100/600	110516031	8324865	135,16
100/1000	110516032	8324866	198,21
125/300	110516033	8324867	158,39
125/600	110516034	8324868	141,31
125/1000	110516035	8324869	212,53
160/300	110516036	8324870	133,31
160/600	110516037	8324871	151,31
160/1000	110516038	8324872	222,35
200/300	110516039	8324873	185,08
200/600	110516040	8324874	198,53
200/1000	110516041	8324875	246,52
250/600	110516042	8324876	209,16
250/1000	110516043	8324877	308,82
315/600	110516044	8324878	253,67
315/1000	110516045	8324879	356,10
400/600	110516046	8324880	340,74
400/1000	110516047	8324881	455,50
500/600	110516048	8324882	433,19
500/1000	110516049	8324883	647,11
630/600	110516050	8324884	647,11
630/1000	110516051	8324885	839,57

**Avattava äänenvaimennin, suorakaide-pyöreät liittokset, polyesterieriste
NTPA**

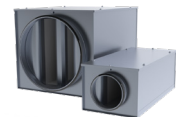

Koko-pituus Ød - L	Tuotekoodi	LVI-koodi	Hinta €-kpl
100/300	110516052	8324886	126,58
100/600	110516053	8324887	136,62
100/1000	110516054	8324888	201,25
125/300	110516055	8324889	132,70
125/600	110516056	8324890	142,58
125/1000	110516057	8324891	213,91
160/300	110516058	8324892	144,27
160/600	110516059	8324893	153,03
160/1000	110516060	8324894	224,37
200/300	110516061	8324895	155,24
200/600	110516062	8324896	169,97
200/1000	110516063	8324897	247,18
250/600	110516064	8324898	211,62
250/1000	110516065	8324899	303,04
315/600	110516066	8324900	255,44
315/1000	110516067	8324901	357,95
400/600	110516068	8324902	343,09
400/1000	110516069	8324903	451,47
500/600	110516070	8324904	427,73
500/1000	110516071	8324905	651,73
630/600	110516072	8324906	651,73
630/1000	110516073	8324907	847,39

NORDsilencer – Äänenvaimentimet

Äänenvaimennin, suorakaide-pyöreät liitokset, lasikuituhuovalla suojattu mineraalivilla
NTF

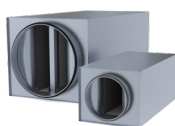

Koko-pituus Ød - L	Tuotekoodi	LVI-koodi	Hinta €-kpl
100/300	110515001	8324842	81,61
100/600	110515002	8324843	101,43 •
100/1000	110515003	8324844	150,70
125/300	110515004	8324845	84,10
125/600	110515005	8324846	114,16 •
125/1000	110515006	8324847	154,41 •
160/300	110515007	8324848	94,56
160/600	110515008	8324849	141,85 •
160/1000	110515009	8324850	173,36 •
200/300	110515010	8324851	99,67
200/600	110515011	8324852	144,83 •
200/1000	110515012	8324853	200,08 •
250/600	110515013	8324854	183,65
250/1000	110515014	8324855	234,07 •
315/600	110515015	8324856	208,94
315/1000	110515016	8324857	283,34 •
400/600	110515017	8324858	265,93
400/1000	110515018	8324859	398,84 •
500/600	110515019	8324860	350,00
500/1000	110515020	8324861	504,20
630/600	110515021	8324862	433,93
630/1000	110515022	8324863	669,18

Äänenvaimennin, suorakaide-pyöreät liitokset, polyesterieriste
NTP

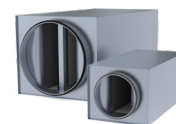

Koko-pituus Ød - L	Tuotekoodi	LVI-koodi	Hinta €-kpl
100/300	110515030	8324820	91,58 •
100/600	110515031	8324821	104,32 •
100/1000	110515032	8324822	151,09 •
125/300	110515033	8324823	100,30 •
125/600	110515034	8324824	117,30 •
125/1000	110515035	8324825	159,40 •
160/300	110515036	8324826	108,14 •
160/600	110515037	8324827	131,12 •
160/1000	110515038	8324828	179,14 •
200/300	110515039	8324829	114,50
200/600	110515040	8324830	141,05 •
200/1000	110515041	8324831	199,12 •
250/600	110515042	8324832	159,43 •
250/1000	110515043	8324833	249,73 •
315/600	110515044	8324834	182,06 •
315/1000	110515045	8324835	287,65 •
400/600	110515046	8324836	280,68 •
400/1000	110515047	8324837	413,31 •
500/600	110515048	8324838	388,25 •
500/1000	110515049	8324839	518,15 •
630/600	110515050	8324840	504,43 •
630/1000	110515051	8324841	772,91 •

Kulmaäänenvaimennin, liitos sivussa (polyesteri)
NKL



(ilman reikäpeltiä)

Koko-pituus Ød - L	Tuotekoodi	LVI-koodi	Hinta €-kpl
100-600	110516001	8324908	128,07 •
100-1000	110516002	8324909	188,87 •
125-600	110516003	8324910	137,24 •
125-1000	110516004	8324911	199,26 •
160-600	110516005	8324912	150,79 •
160-1000	110516006	8324913	223,93 •
200-600	110516007	8324914	165,02 •
200-1000	110516008	8324915	248,91 •

Kulmaäänenvaimennin, liitos päällä (polyesteri)
NKU



(ilman reikäpeltiä)

Koko-pituus Ød - L	Tuotekoodi	LVI-koodi	Hinta €-kpl
100-600	110516010	8324916	128,07 •
100-1000	110516011	8324917	188,87 •
125-600	110516012	8324918	137,24 •
125-1000	110516013	8324919	199,26 •
160-600	110516014	8324920	150,79 •
160-1000	110516015	8324921	223,93 •
200-600	110516016	8324922	165,02 •
200-1000	110516017	8324923	248,91 •

Äänenvaimennin, suorakaide-pyöreät liitokset, polyesterieriste 50 mm
NKE



(ilman reikäpeltiä)

Koko-pituus Ød - L	Tuotekoodi	LVI-koodi	Hinta €-kpl
100-600	110514001	8324277	90,92 •
100-1000	110514005	8324281	135,98 •
125-600	110514002	8324278	95,04 •
125-1000	110514006	8324282	142,25 •
160-600	110514003	8324279	103,42 •
160-1000	110514007	8324283	158,28 •
200-600	110514004	8324280	120,05 •
200-1000	110514008	8324284	181,16 •

Ilmanvaihtokanavajärjestelmät

NORDsilencer – Äänenvaimentimet

Taipuisa vaimennin
AKU-COMP

Koko	Pituus	Tuotekoodi	LVI-koodi	Hinta €/kpl	kpl/ laatikko
100	0,3-0,6	10820100	8324800	93,06	• 96
125	0,3-0,6	10820125	8324801	98,11	• 70
160	0,3-0,6	10820160-1	8324802	101,78	• 40
200	0,3-0,6	10820200-1	8324803	149,88	• 34
250	0,3-0,6	10820250-1	8324804	180,38	• 22
315	0,3-0,6	10820315-1	8324805	208,64	• 12
100	1,2	10820100-1	8324806	128,23	• 60
125	1,2	850000021	8324807	107,77	• 40
160	1,2	10820160	8324808	120,71	• 30
200	1,2	10820200	8324809	155,92	• 21
250	1,2	10820250	8324810	183,76	• 12
315	1,2	10820315	8324811	220,96	• 8

Suorakaidekanavien äänenvaimentimet

Eristysmateriaalit: polyesteri, Cleantec, lasikuituhuovalla suojattu mineraalivilla
Hinnat tarjouksen mukaan.

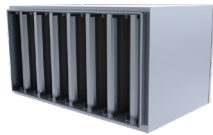
Suorakaideäänenvaimennin
MSK/MSPSuorakaideäänenvaimennin,
eristetty
MSKI/MSPIAvattava
suorakaideäänenvaimennin
MSKAKulmaäänenvaimennin
MPK

8. NORDroof – Kattojärjestelmät

Ilmanottokatos sadepeltiilitoksella ULS+KL

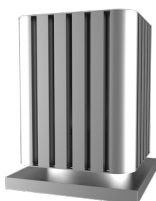

Koko Ød + KL	Tuotekoodi	LVI-koodi	Hinta €/kpl
160/400x400	2016084	8632314	1113,90
200/400x400	2016091	8632315	1207,93
250/500x500	2016107	8632316	1289,31
315/500x500	2016114	8632317	1892,53
400/600x600	2016121	8632318	2077,52
500/700x700	2016138	8632319	2371,20
630/800x800	2016145	8632320	3070,01
800/1000x1000	2016183	8632321	3813,66
1000/1200x1200	2016190	8632322	5452,33
1250/1500x1500	2016206	8632323	6195,88
1600/1800x1800	2016213	8632324	8254,40

Ilmanottokatos ULS



Koko Ød	Tuotekoodi	LVI-koodi	Hinta €/kpl
160	830000902	8632046	1113,90
200	830000901	8632047	1207,93
250	830000617	8632048	1289,31
315	830000354	8632049	1892,53
400	830000409	8632050	2077,52
500	830000227	8632051	2371,20
630	840000102	8632052	3070,01
800	840000413	8632053	3813,66
1000	840000101	8632054	5452,33
1250	840000414	8632055	6195,88

Ilmanottokatos sadepeltiilitoksella URS+KL



Koko Ød + KL	Tuotekoodi	LVI-koodi	Hinta €/kpl
315/500x500	2016220	8632325	1412,12
400/600x600	2016237	8632326	1584,56
500/700x700	2016244	8632327	1925,95
630/800x800	2016251	8632328	2411,11
800/1000x1000	2016275	8632329	2904,05
1000/1200x1200	2016381	8632330	3743,24
1250/1500x1500	2016541	8632331	5024,19

Ilmanottokatos URS

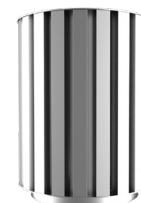

Koko Ød	Tuotekoodi	LVI-koodi	Hinta €/kpl
315	830500315	8632056	1412,12
400	830500400	8632057	1584,56
500	830500500	8632058	1925,95
630	830500630	8632059	2411,11
800	830500800	8632060	2904,05
1000	830501000	8632061	3743,24
1250	830501250	8632062	5024,19

Ilmanottokatos ULK



Erikoismitat ja -värit tarjouksen mukaan.

Koko	Tuotekoodi	LVI-koodi	Hinta €/kpl
3	2014981	8632365	1706,92
4	2015025	8632366	1770,24
5	2015049	8632367	1921,66
6	2015087	8632368	2359,41
7	2015094	8632369	2846,71
8	2015117	8632370	3020,15
9	2015124	8632371	3639,60
10	2015131	8632372	4308,60
11	2015148	8632373	4572,89
12	2015155	8632374	5219,87
13	2015162	8632375	5943,95
14	2015179	8632376	6018,27
15	2015186	8632377	6615,70

Ilmanvaihtokanavajärjestelmät

NORDroof – Kattojärjestelmät

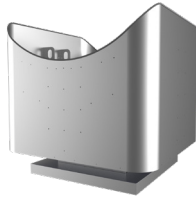
Ulospuhallushajotin
sadeputtiliitoksella
ULV2I

Koko	Tuotekoodi	LVI-koodi	Hinta €/kpl
2/400x400	2015193	8632332	457,94
3/500x500	2015223	8632333	872,85
4/600x600	2015230	8632334	1246,26
5/700x700	2015247	8632335	1755,15
6/800x800	2015254	8632336	2300,93
8/1000x1000	2015261	8632337	2749,42
10/1200x1200	2015278	8632338	3537,61
12/1400x1400	2015285	8632339	4274,68
16/1800x1800	2015346	8632340	8556,32

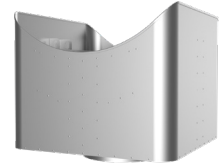
Ulospuhallushajotin
ULV2

Koko Ød	Tuotekoodi	LVI-koodi	Hinta €/kpl
160	6420160-2	8632012	364,56
200	6420200-2	8632013	427,69
250	6420250-2	8632014	523,48
315	6420315-2	8632015	823,38
400	6420400-2	8632016	1161,71
500	6420500-2	8632017	1776,05
630	6420630-2	8632018	2391,90
800	6420800-2	8632019	3121,13
1000	64201000-2	8632020	4023,08
1250	64201250-2	8632021	5017,32

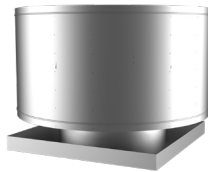
Ilmastointikatos
sadeputtiliitoksella
UVE+KL

Koko	Tuotekoodi	LVI-koodi	Hinta €/kpl
100/400x400	2015711	8632341	197,88
125/400x400	2015735	8632342	228,23
160/400x400	2015797	8632343	245,69
200/400x400	2015803	8632344	260,82
250/500x500	2015827	8632345	282,91
315/500x500	2015926	8632346	485,07
400/600x600	2016015	8632347	607,95
500/700x700	2016022	8632348	975,03
630/800x800	2016039	8632349	1255,81
800/1000x1000	2016053	8632350	1806,31
1000/1200x1200	2016060	8632351	3064,30
1250/1500x1500	2016077	8632352	4229,31

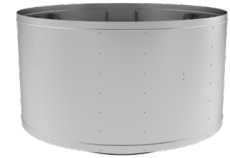
Ilmastointikatos
UVE

Koko Ød	Tuotekoodi	LVI-koodi	Hinta €/kpl
100	840009010	8632000	197,88
125	840009012	8632001	228,23
160	840009016	8632002	245,69
200	840009020	8632003	260,82
250	840009025	8632004	282,91
315	840009031	8632005	485,07
400	840009040	8632006	607,95
500	840009050	8632007	975,03
630	840009063	8632008	1255,81
800	840009080	8632009	1806,31
1000	840009100	8632010	3020,33
1250	840009125	8632011	4229,31

Ilmastointikatos
UVKI

Koko	Tuotekoodi	LVI-koodi	Hinta €/kpl
3	2015353	8632353	568,12
4	2015360	8632354	730,85
5	2015391	8632355	987,65
6	2015452	8632356	1220,73
7	2015483	8632357	1515,88
8	2015490	8632358	1932,51
9	2015506	8632359	2138,22
10	2015520	8632360	2702,91
11	2015551	8632361	3173,68
12	2015643	8632362	3620,41
13	2015650	8632363	4148,64
14	2015667	8632364	5293,00

Sadekatos
NTH

Koko Ød	Tuotekoodi	LVI-koodi	Hinta €/kpl
100	10210010	8632073	65,95 •
125	10210220	8632074	68,76 •
160	10210260	8632075	85,62 •
200	10210200	8632076	98,26 •
250	10210250	8632077	114,01 •
315	10210310	8632078	121,49 •
400	10210400	8632079	154,50 •
500	10210500	8632080	265,54
630	10210630	8632081	346,53
800	10210800	8632202	758,70

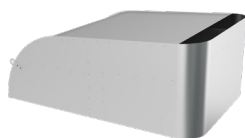
NORDroof – Kattojärjestelmät
**Yhdistelmälaite
UHC**

Koko	Tuotekoodi	LVI-koodi	Hinta €/kpl
200	110608001	8816843	1824,44
300	110608002	8816844	1881,46
400	110608003	8816845	1938,49
500	110608004	8816846	2052,50
600	110608005	8816847	2280,57
700	110608006	8816848	2508,61
800	110608007	8816849	2679,65
900	110608008	8816850	2791,98
1000	110608009	8816851	2964,73
1100	110608010	8816852	3192,77

**Kattoläpivienti
UHCT**

Koko	Tuotekoodi	LVI-koodi	Hinta €/kpl
200	110609001	7806226	780,27
300	110609002	7806227	811,48
400	110609003	7806228	865,26
500	110609004	7806229	951,92
600	110609005	7806230	1086,80
700	110609006	7806231	1264,70
800	110609007	7806232	1455,00
900	110609008	7806233	1616,64
1000	110609009	7806234	1765,44
1100	110609010	7806235	1872,64

**Kattoläpivienti
MKLI
Eriste 50 mm**

Koko	Tuotekoodi	LVI-koodi	Hinta €/kpl
2-50-1200	2836774	7806246	458,99
3-50-1200	2823798	7806247	545,84
4-50-1200	2983911	7806248	632,76
5-50-1200	2916117	7806249	719,62
6-50-1200	2831434	7806250	811,04
7-50-1200	2854563	7806251	897,96
8-50-1200	2988084	7806252	1107,21
9-50-1200	2932773	7806253	1198,08
10-50-1200	2893715	7806254	1288,93
11-50-1200	2964026	7806255	1379,84
12-50-1200	2846520	7806256	1482,56
13-50-1200	2941843	7806257	1573,41
14-50-1200	2824672	7806258	1757,47
15-50-1200	2912546	7806259	1854,28
16-50-1200	2888322	7806260	1951,10

**Laippa, kuumasinkitty
VRL**

Erikoismitat ja -värit tarjouksen mukaan.
Saatavilla myös haponkestävänä.

Koko Ød	Tuotekoodi	LVI-koodi	Hinta €/kpl
100	830000446	8632082	56,01
125	830000447	8632083	70,01
160	830000448	8632084	79,70
200	830000449	8632085	92,62
250	830000194	8632086	103,64
315	830000195	8632087	139,40
400	830000450	8632088	175,69
500	830000057	8632032	235,63 •
630	830000198	8632033	303,59 •
800	830000199	8632034	382,91 •
1000	830000200	8632035	600,48 •
1250	830000201	8632036	691,86 •

**Alipainepelti
MKLT**

Koko	Tuotekoodi	LVI-koodi	Hinta €/kpl
2	2017500	7806341	111,00
3	2017517	7806342	125,81
4	2017524	7806343	141,55
5	2017548	7806344	158,31
6	2017562	7806345	176,12
7	2017586	7806346	196,27
8	2017685	7806347	216,01
9	2017760	7806348	237,87

Koko	Tuotekoodi	LVI-koodi	Hinta €/kpl
10	2017852	7806349	259,44
11	2017944	7806350	282,05
12	2018156	7806351	305,57
13	2018163	7806352	330,14
14	2018170	7806353	355,75
15	2018217	7806354	382,13
16	2018224	7806355	409,68

NORDroof – Kattojärjestelmät

Pyöreä liitin kattoläpivientiin MKLV



Koko	Tuotekoodi	LVI-koodi	Hinta €/kpl
2-100-400x400	2018583	7806276	37,05
2-100-500x500	2018651	7806280	42,90
2-125-400x400	2018620	7806277	37,05
2-125-500x500	2018668	7806281	42,90
2-160-400x400	2018637	7806278	37,31
2-160-500x500	2018675	7806282	43,15
2-200-400x400	2018644	7806279	37,56
2-200-500x500	2018682	7806283	43,41
3-250-500x500	2018699	7806284	44,06
3-250-600x600	2018712	7806286	50,83
3-315-500x500	2018705	7806285	44,45
3-315-600x600	2018729	7806287	51,22
4-315-700x700	2018743	7806289	59,01
4-400-600x600	2018736	7806288	52,90
5-400-700x700	2018750	7806290	60,70
5-400-800x800	2018774	7806292	69,41
5-500-700x700	2018767	7806291	66,93
5-500-800x800	2018781	7806293	75,52
6-500-900x900	2018804	7806295	85,13
6-630-800x800	2018798	7806294	80,58
6-630-900x900	2018828	7806296	90,07
7-500-1000x1000	2018835	7806297	95,67
7-630-1000x1000	2018842	7806298	100,73
8-800-1000x1000	2018972	7806299	198,34
9-800-1100x1100	2018989	7806300	221,87
9-800-1200x1200	2018996	7806301	247,22
10-1000-1200x1200	2019009	7806302	257,35
10-1000-1300x1300	2019023	7806303	284,66
11-1000-1400x1400	2019030	7806304	313,77
12-1250-1400x1400	2019047	7806305	321,82
12-1250-1500x1500	2019054	7806306	352,88
13-1250-1600x1600	2019061	7806307	385,64
14-1250-1700x1700	2019078	7806308	420,35
15-1250-1800x1800	2019085	7806309	456,99
16-1600-1800x1800	2019092	7806310	475,45
16-1600-1900x1900	2019108	7806311	513,93

Alipainepelti MKLU



Koko	Tuotekoodi	LVI-koodi	Hinta €/kpl
2-100-200x200	2018231	7806312	63,82
2-125-200x200	2018255	7806313	63,82
2-160-200x200	2018262	7806314	64,21
2-200-200x200	2018279	7806315	64,85
3-200-300x300	2018316	7806316	73,95
3-250-300x300	2018323	7806317	74,61
3-315-300x300	2018577	7806318	77,99
4-200-400x400	2018330	7806319	84,22
4-250-400x400	2018347	7806320	84,62
4-315-400x400	2018354	7806321	84,49
4-400-400x400	2018361	7806322	86,18
5-315-500x500	2018378	7806323	95,14
5-400-500x500	2018385	7806324	95,79
5-500-500x500	2018392	7806325	97,22
6-400-600x600	2018415	7806326	109,96
6-500-600x600	2018422	7806327	110,10
6-630-600x600	2018578	7806328	111,78
7-500-700x700	2018439	7806329	124,91
7-630-700x700	2018446	7806330	122,83
8-630-800x800	2018453	7806331	143,49
8-800-800x800	2018460	7806332	153,89
9-800-900x900	2018477	7806333	178,07
10-1000-1000x1000	2018484	7806334	217,58
11-1000-1100x1100	2018507	7806335	240,98
12-1000-1200x1200	2018514	7806336	264,12
13-1250-1300x1300	2018521	7806337	276,33
14-1250-1400x1400	2018538	7806338	299,98
15-1250-1500x1500	2018545	7806339	330,40
16-1600-1600x1600	2018576	7806340	339,89

9. NORDexternal – Ulkosäleiköt ja lumisuojat

Ulkosäleikkö

RV



Mitat: leveys x korkeus

Vakioväri RAL7000

Erikoismitat ja -värit tarjouksen mukaan.

Korkeus	Leveys												
	200	300	400	500	600	700	800	1000	1200	1400	1600	1800	2000
200	377,00	608,94	407,68	423,16	438,36	453,84	469,14	500,85	531,62	733,17	764,03	797,25	828,02
300	401,20	676,25	438,55	457,22	475,89	494,56	513,42	552,27	589,61	812,82	850,26	890,61	928,14
400	425,32	854,00	469,42	491,37	513,42	535,38	557,52	603,50	647,60	892,39	936,30	984,53	1028,44
500	449,43	904,25	500,10	525,53	550,95	576,29	601,53	654,82	705,49	971,58	1022,62	1077,98	1128,74
600		954,41	531,06	559,77	588,48	617,20	645,81	706,14	763,47	1051,24	1108,57	1171,43	1229,04
800		268,31	592,61	628,17	663,55	698,92	734,29	808,60	879,35	1210,37	1281,02	1358,62	1429,46
1000		296,49	654,35	696,48	738,70	780,55	822,68	911,06	995,22	1369,03	1453,01	1545,71	1630,15
1200		312,72	716,00	764,79	813,67	862,27	911,06	1013,71	1111,10	1527,79	1625,27	1732,99	1830,38
1400		456,27	796,50	852,14	907,68	962,95	1018,40	1083,23	1246,12	1713,38	1824,28	1946,82	2057,54
1600		484,55	1003,76	1071,60	1139,53	1207,56	1275,30	1134,93	1553,21	2173,32	2308,99	2458,83	2593,66
1800		540,72	1065,69	1139,91	1214,78	1288,90	1363,68	1417,63	1669,37	2332,36	2481,17	2645,74	2794,45
2000		597,18	1127,43	1208,59	1289,75	1370,91	1451,79	1520,38	1785,06	2491,02	2653,34	2832,55	2994,78

Ulkosäleikkö

RV-D2



Mitat: leveys x korkeus - halkaisija

Vakioväri RAL7000

Erikoismitat ja -värit tarjouksen mukaan.

Koko B x H	D2	Tuotekoodi	LVI-koodi	Hinta €/kpl
200x200	125	501020020-125	8816601	481,71
200x200	160	501020020-160	8816602	483,68
250x250	200	501025025-200	8816603	509,39
300x300	250	501030030-250	8816607	540,16
400x400	315	501040040-315	8816612	592,24
450x450	400	501045045-400	8816613	629,02

Lumisuoja

RVR

Vakioväri RAL7000

Erikoismitat ja -värit tarjouksen mukaan.

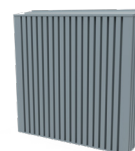

Lumisuoja, upotettava

RVLU

Vakioväri RAL7000.

Erikoismitat ja -värit tarjouksen mukaan.



Yhdistetty ulko- ja poistoilmalaite

RVD

Vakioväri RAL7000

Koko Ød	Tuotekoodi	LVI-koodi	Hinta €/kpl
125	901100320	8816853	352,25
125L	901100324	8741226	424,22
160	901100321	8816854	424,27
200	901100322	8816855	497,84
250	901100323	8816856	617,10
250L	901100325	8741227	723,82

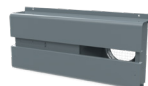

Ulkosäleikkö lämmitettävillä säleillä

RVUK

Vakioväri RAL7000.

Erikoismitat ja -värit tarjouksen mukaan.



Ulkosäleikkö

RVA

Valettu alumiinista

Koko	Tuotekoodi	LVI-koodi	Hinta €/kpl
100	5030100	8816825	7,12 •
125	5030125	8816826	8,70 •
160	5030160	8816827	14,87 •
200	5030200	8816828	17,68 •
250	5030250	8816829	33,58 •
315	5030315	8816830	51,61 •
400	5030400	8816831	103,84 •
100x100	503100100	8816832	25,73
150x150	503150150	8816833	36,21
200x200	503200200	8816834	54,92



RVDS Tuloilmäsäleikkö

Koko	Tuotekoodi	LVI-koodi	Hinta €/kpl
125	901100330	8741228	288,41
160	901100331	8741229	345,86
200	901100332	8741230	401,89
250	901100333	8741231	488,13

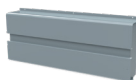

RVDV Poistoilmäsäleikkö

Koko	Tuotekoodi	LVI-koodi	Hinta €/kpl
125	901100340	8741232	311,48
160	901100341	8741233	370,79
200	901100342	8741234	435,84
250	901100343	8741235	541,71



Ilmanvaihtokanavajärjestelmät

10. Pyöreä kanavajärjestelmä, 1,25 mm

Kierresaumakanava,
Pituus 3 m
NTO-S 1,2

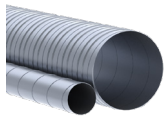

Koko øD	Tuotekoodi	LVI-koodi	Hinta €/m
100	840000039	8103141	34,97
125	840000023	8103142	42,80
160	840000038	8103143	49,00 •
200	840000239	8103144	62,92 •
250	840000238	8103145	76,94 •
315	840000219	8103146	94,25 •
400	840000077	8103147	137,84 •
500	840000192	8103148	149,85 •
630	840000228	8103149	229,06 •
800	840000229	8103150	285,85 •
1000	840000231	8103151	412,70
1250	840000233	8103152	515,47

Käyrä 45°
NV-S 1,2



Koko ød	Tuotekoodi	LVI-koodi	Hinta €/kpl
125	830000465-5	8113017	102,49
160	830001650	8113018	105,04 •
200	83012245	8113019	119,38 •
250	830122545	8113020	133,54 •
315	83202315	8113021	172,29 •
400	83202404	8113022	208,58 •
500	8301277	8113023	247,17 •
630	8301211	8113024	300,17 •
800	8301220	8113025	492,99 •
1000	8301218	8113026	670,35
1250	8301212	8113027	951,08

Käyrä 90°
NV-S 1,2



Koko ød	Tuotekoodi	LVI-koodi	Hinta €/kpl
100	83202019	8113001	120,66
125	830000236	8113002	127,82 •
160	83202169	8113003	133,97 •
200	8301224	8113004	153,61 •
250	8301223	8113005	162,98 •
315	830000160	8113006	213,50 •
400	8301219	8113007	290,85 •
500	8301276	8113008	387,00 •
630	8301210	8113009	477,99 •
800	8301216	8113010	669,12 •
1000	8301217	8113011	944,94
1250	8301213	8113012	1291,71

Sisäliitin
NI-S 1,2



Koko ød	Tuotekoodi	LVI-koodi	Hinta €/kpl
100	830001651	8113090	27,05
125	83203120	8113091	27,31
160	83203160	8113092	28,07 •
200	83203200	8113093	30,68 •
250	83203251	8113094	35,18 •
315	83203311	8113095	37,25 •
400	83203400	8113096	39,79 •
500	8301279	8113097	51,42 •
630	8301221	8113098	63,89 •
800	8301214	8113099	89,81 •
1000	830001252	8113100	121,28
1250	8301215	8113101	171,06

Ulkoliitin
NM-S 1,2



Koko øD	Tuotekoodi	LVI-koodi	Hinta €/kpl
100	830001652	8113105	25,28
125	830001653	8113106	25,78
160	830001654	8113107	26,31
200	830001655	8113108	26,85
250	830001656	8113109	28,79
315	830001657	8113110	33,35
400	830001658	8113111	39,79
500	830001659	8113112	42,33
630	830001660	8113113	55,11
800	830001661	8113114	87,43
1000	830001662	8113115	121,28
1250	830001663	8113116	171,06

Lähtökaulus tasopinnalle
NSK-S 1,2



Koko ød	Tuotekoodi	LVI-koodi	Hinta €/kpl
100	830001664	8113121	26,31
125	830001665	8113122	28,79
160	830001666	8113123	29,74 •
200	830000165	8113124	30,55 •
250	830001667	8113125	31,53 •
315	830000164	8113126	36,85 •
400	8320400	8113127	37,93 •
500	83205500	8113128	42,16 •
630	83205600	8113129	55,21 •
800	KP00030	8113130	81,16
1000	83205601	8113131	113,63
1250	830001668	8113132	158,65

Tulppa kanavalle
NAL-S 1,2



Koko ød	Tuotekoodi	LVI-koodi	Hinta €/kpl
125	830001786	8113137	54,92
160	830001787	8113138	55,47
200	830001788	8113139	56,03 •
250	10208250-3	8113140	58,59 •
315	83208315	8113141	66,85 •
400	83208400	8113142	75,82 •
500	83208500	8113143	90,10 •
630	83208630	8113144	108,71 •
800	83208800	8113145	169,83
1000	83012100	8113146	238,47
1250	8301280	8113147	333,41

Tulppa osalle
NALM-S 1,2



Koko øD	Tuotekoodi	LVI-koodi	Hinta €/kpl
125	10208125-0	8113151	53,47
160	10208200-4	8113152	54,54
200	830001796	8113153	55,60
250	830001797	8113154	58,59
315	830001798	8113155	66,85
400	830001799	8113156	75,82
500	830001800	8113157	84,63
630	10208630-3	8113158	108,71
800	830001801	8113159	170,37
1000	8300018891	8113160	238,47
1250	830001802	8113161	333,41

Pyöreä kanavajärjestelmä, 1,25 mm

**Muunto,
epäkeskeinen,
osakoko
NFB-S 1,2**



**Lähtökaulus,
lyhyt kaulus
NPSK-S 1,2**

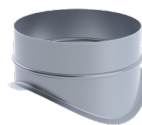

**Lähtökaulus
NPSV-S 1,2**

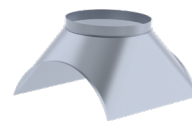

Koko Ød1-d2	Tuotekoodi	LVI- koodi	Hinta €/kpl
125/100	830001843	8113205	146,36
160/100	830001844	8113206	150,82
160/125	830001845	8113207	152,82
200/100	830001846	8113210	156,16
200/125	830001847	8113208	157,26
200/160	830001848	8113209	158,08
250/100	830001849	8113375	176,27
250/125	830001850	8113212	181,22
250/160	830001851	8113213	183,45
250/200	830001852	8113214	186,69
315/125	830001083	8113217	199,13
315/160	830001853	8113218	199,94
315/200	830001854	8113219	204,06
315/250	830001855	8113220	213,37 •
400/125	830001856	8113376	234,60
400/160	830001857	8113377	238,84
400/200	830001858	8113225	240,97
400/250	830001859	8113226	249,45
400/315	830001860	8113227	254,61 •
500/125	830001861	8113378	193,25
500/160	830001862	8113379	200,99
500/200	830001863	8113232	278,87
500/250	830001864	8113233	288,47
500/315	830001865	8113234	288,47
500/400	83209504-2	8113235	288,47 •
630/160	830001866	8113380	349,72
630/200	830001867	8113240	349,72
630/250	830001868	8113241	349,72
630/315	830001869	8113242	349,72
630/400	830001870	8113243	355,89
630/500	8301278	8113244	357,72 •
800/315	830001871	8113251	564,61
800/400	830001872	8113252	564,61
800/500	83209505-3	8113253	524,98
800/630	83209505-2	8113254	524,98
1000/315	830001873	8113381	446,80
1000/400	830001874	8113261	612,41
1000/500	830001875	8113255	655,49
1000/630	830001876	8113256	655,49
1000/800	83012525	8113257	655,49
1250/400	830001877	8113262	892,40
1250/500	830001878	8113263	892,40
1250/630	830001879	8113258	987,00
1250/800	830001880	8113259	991,77
1250/1000	8301253	8113260	991,77

Koko ØD-d2	Tuotekoodi	LVI- koodi	Hinta €/kpl
100/100	83206010-1	8113300	50,45
125/100	830001681	8113301	51,32
125/125	83206121-2	8113302	54,47
160/100	83206160-1	8113303	49,54
160/125	83206161-2	8113304	51,04
160/160	83206161-6	8113305	52,07
200/100	830001682	8113500	49,68
200/125	830001683	8113306	52,38
200/160	830001684	8113307	52,82
200/200	830001685	8113308	56,10
250/100	830001686	8113501	50,29
250/125	830001687	8113502	51,46
250/160	830001688	8113309	52,68
250/200	830001689	8113310	55,38
250/250	830001690	8113311	61,32
315/100	830001691	8113503	49,83
315/125	830000238	8113504	51,04
315/160	830001692	8113312	52,24
315/200	830001693	8113313	55,83
315/250	830001694	8113314	58,34
315/315	10206313-3	8113315	67,60
400/100	830001695	8113505	49,54
400/125	830001696	8113506	50,59
400/160	830001697	8113507	52,38
400/200	830000163	8113316	54,47
400/250	830001698	8113317	57,31
400/315	110935055	8113527	58,32
500/160	83206501-6	8113508	52,24
500/200	10206502-2	8113509	54,02
500/250	830001699	8113320	56,10
500/315	830001700	8113321	60,75
630/125	830001702	8113511	51,04
630/160	830001703	8113512	52,38
630/200	830001704	8113513	54,61
630/250	830001705	8113514	56,84
630/315	830001706	8113551	61,18
800/160	830001708	8113516	52,98
800/200	830001709	8113517	53,74
800/250	830001710	8113518	57,17
800/315	830001711	8113519	60,89
1000/160	830001713	8113521	54,30
1000/200	830001714	8113522	54,91
1000/250	830001715	8113523	56,99
1000/315	830001716	8113524	61,32
1250/250	830001717	8113525	56,99
1250/315	830001718	8113526	59,54

Koko ØD-d2	Tuotekoodi	LVI- koodi	Hinta €/kpl
400/400	830001719	8113319	145,42
500/400	830001720	8113322	154,01
500/500	830001721	8113323	165,06
630/400	830001722	8113325	154,97
630/500	830001723	8113326	172,98
630/630	830001724	8113327	193,98
800/400	830001725	8113328	160,69
800/500	830001726	8113329	173,79
800/630	830001727	8113330	211,17
800/800	830001728	8113331	292,73
1000/400	830001729	8113351	169,57
1000/500	830001730	8113332	188,26
1000/630	830001731	8113333	214,98
1000/800	830001732	8113334	305,03
1000/1000	830001733	8113335	415,25
1250/400	830001734	8113353	189,61
1250/500	830001735	8113354	206,68
1250/630	10206156-6	8113336	233,55
1250/800	830001736	8113337	332,57
1250/1000	830001737	8113338	442,11
1250/1250	830001738	8113339	535,15

Ilmanvaihtokanavajärjestelmät

Pyöreä kanavajärjestelmä, 1,25 mm

T-yhde NTK-S 1,2



Koko Ød1-d2	Tuotekoodi	LVI-koodi	Hinta €/kpl
100/100	830001739	8113414	115,33
125/100	830001740	8113415	118,28
125/125	831000501-0	8113416	122,46
160/100	830001741	8113417	119,12
160/125	EK00457	8113418	121,50
160/160	830001742	8113419	124,02 •
200/100	830001743	8113421	122,06
200/125	830001744	8113422	126,40
200/160	EK00458	8113423	128,09
200/200	102072020	8113424	133,82 •
250/100	830001745	8113426	126,27
250/125	830001746	8113427	128,79
250/160	830001747	8113428	132,84
250/200	EK00459	8113429	137,91
250/250	830001748	8113430	146,99 •
315/100	830001749	8113432	129,49
315/125	830001750	8113433	134,82
315/160	830001751	8113434	138,18
315/200	102073120	8113435	150,37
315/250	102073125	8113436	156,67
315/315	102073131	8113437	171,25 •
400/100	830001752	8113439	143,22
400/125	830001753	8113440	144,34
400/160	830001754	8113441	151,08
400/200	830001755	8113442	158,21

T-yhde NTKV-S 1,2

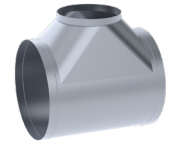

Koko ØD-d2	Tuotekoodi	LVI-koodi	Hinta €/kpl
400/400	10207404-2	8113445	296,11 •
500/400	EK00965	8113453	324,42
500/500	EK00564	8113454	348,51 •
630/400	EK00966	8113462	353,27
630/500	10630316	8113463	393,36
630/630	10630316-6	8113464	419,42 •
800/400	830001770	8113472	408,78
800/500	830001771	8113473	442,26
800/630	830001772	8113474	531,67
800/800	83000067-8	8113475	641,81
1000/400	830001777	8113488	437,50
1000/500	831000500	8113476	506,04
1000/630	830001778	8113477	596,28
1000/800	83000067-0	8113478	720,02
1000/1000	110938062	8113479	826,13
1250/400	830001781	8113491	539,09
1250/500	830001782	8113492	587,88
1250/630	830001783	8113480	783,07
1250/800	830001784	8113481	886,78
1250/1000	831000502	8113482	1095,43
1250/1250	831000501	8113483	1289,10

Imukartio suojaverkolla NK-S 1,2



Koko ød	Tuotekoodi	LVI-koodi	Hinta €/kpl
100	10206011	8113912	62,29
125	10206012	8113913	64,05
160	10206016	8113914	66,23
200	10206200-2	8113915	71,27
250	10206250-2	8113916	77,54
315	10206031	8113917	86,97
400	10206404	8113918	119,53
500	10206500-0	8113919	139,84
630	102066630	8113920	165,94
800	10206800	8113921	215,95
1000	102061000	8113922	291,07
1250	102061250	8113923	346,02

Säätöpelti KROS-S 1,2



Koko ød	Tuotekoodi	LVI-koodi	Hinta €/kpl
100	840000448	8406486	182,47
125	840000450	8406487	187,07
160	840000452	8406488	191,66
200	840000453	8406489	218,49
250	840000454	8406490	220,80
315	840000247	8406491	257,60
400	840000248	8406492	349,61

11. Pyöreä kanavajärjestelmä, Magnelis (ZM310)

**Kierresaumakanava,
pituus 3 m
NTO-ZM**

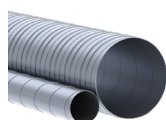

Koko ød	Tuotekoodi	LVI-koodi	Hinta €/m
80	111260001	8117000	52,60
100	111260002	8117001	19,05
125	111260005	8117002	22,16
160	111260006	8117003	27,85
200	111260007	8117004	35,05
250	111260008	8117005	42,53
315	111260009	8117006	56,18
400	111260011	8117007	106,87
500	111260012	8117008	131,62
630	111260013	8117009	163,44
800	111260014	8117010	208,92
1000	111260015	8117011	405,00
1250	111260016	8117012	447,96
1600	111260017	8117013	679,10

**Kierresaumakanava,
pituus 6 m
NTO-ZM**



Tuotekoodi	LVI-koodi	Hinta €/m
111260020	8117014	42,76
111260021	8117015	15,49
111260022	8117016	18,01
111260023	8117017	22,64
111260024	8117018	28,49
111260025	8117019	34,59
111260026	8117020	45,67
111260027	8117021	86,89
111260028	8117022	107,01
111260029	8117023	132,88
111260030	8117024	169,86
111260031	8117025	329,27
111260032	8117026	447,96
111260033	8117027	679,10

**Käyrä 90°
NV-ZM**



Koko ød	Tuotekoodi	LVI-koodi	Hinta €/m
100	111260040	8117028	30,29
125	111260041	8117029	31,69
160	111260042	8117030	34,47
200	111260043	8117031	37,72
250	111260044	8117032	51,02
315	111260045	8117033	59,48
400	111260046	8117034	119,76
500	111260047	8117035	151,09
630	111260048	8117036	209,51
800	111260049	8117037	381,38
1000	111260050	8117038	679,39
1250	111260051	8117039	936,13
1600	111260052	8117040	1576,61

**Käyrä 60°
NV-ZM**



Koko ød	Tuotekoodi	LVI-koodi	Hinta €/kpl
100	111260060	8117041	63,65
125	111260061	8117042	61,44
160	111260062	8117043	66,66
200	111260063	8117044	65,14
250	111260064	8117045	75,80
315	111260065	8117046	84,77
400	111260066	8117047	103,43
500	111260067	8117048	128,55
630	111260068	8117049	166,63
800	111260069	8117050	324,64
1000	111260070	8117051	543,74
1250	111260071	8117052	720,93
1600	111260072	8117053	1269,41

**Käyrä 45°
NV-ZM**



Tuotekoodi	LVI-koodi	Hinta €/kpl
111260080	8117054	21,57
111260081	8117055	22,63
111260082	8117056	24,41
111260083	8117057	27,00
111260084	8117058	36,31
111260085	8117059	44,04
111260086	8117060	95,62
111260087	8117061	116,90
111260088	8117062	150,64
111260089	8117063	290,22
111260090	8117064	489,22
111260091	8117065	637,22
111260092	8117066	1045,76

**Käyrä 30°
NV-ZM**



Tuotekoodi	LVI-koodi	Hinta €/kpl
111260100	8117067	62,76
111260101	8117068	63,55
111260102	8117069	74,58
111260103	8117070	66,32
111260104	8117071	70,06
111260105	8117072	76,71
111260106	8117073	89,13
111260107	8117074	105,37
111260108	8117075	132,20
111260109	8117076	262,94
111260110	8117077	436,51
111260111	8117078	555,27
111260112	8117079	903,22

**Käyrä 15°
NV-ZM**



Koko ød	Tuotekoodi	LVI-koodi	Hinta €/kpl
100	111260120	8117080	59,00
125	111260121	8117081	60,20
160	111260122	8117082	60,20
200	111260123	8117083	75,37
250	111260124	8117084	69,34
315	111260125	8117085	74,74
400	111260126	8117086	82,92
500	111260127	8117087	96,84
630	111260128	8117088	116,74
800	111260129	8117089	237,92
1000	111260130	8117090	384,83
1250	111260131	8117091	474,50
1600	111260132	8117092	812,26

**Käyrä, jyrkkä
NVK-ZM**



Tuotekoodi	LVI-koodi	Hinta €/kpl
111261041	8118245	61,73
111261042	8118246	81,66
111261043	8118247	97,33
111261044	8118248	182,76
111261045	8118249	230,55
111261046	8118250	300,89
111261047	8118251	544,40
111261048	8118252	966,61
111261049	8118253	1330,28

**Käyrä, jyrkkä
(kanava/osa)
NVKM-ZM**



Tuotekoodi	LVI-koodi	Hinta €/kpl
111261051	8117511	65,80
111261052	8117512	87,07
111261053	8117513	103,72
111261054	8117514	195,81
111261055	8117515	247,09
111261056	8117516	323,72
111261057	8117517	587,65
111261058	8117518	1043,52
111261059	8117519	1436,41

Ilmanvaihtokanavajärjestelmät

Pyöreä kanavajärjestelmä, Magnelis (ZM310)

Sisäliitin NI-ZM



Koko ød	Tuotekoodi	LVI-koodi	Hinta €/kpl
80	111260140	8117093	77,99
100	111260141	8117094	7,87
125	111260142	8117095	8,01
160	111260143	8117096	9,18
200	111260144	8117097	9,30
250	111260145	8117098	14,41
315	111260146	8117099	17,31
400	111260147	8117100	56,37
500	111260148	8117101	62,94
630	111260149	8117102	66,85
800	111260150	8117103	124,54
1000	111260151	8117104	149,45
1250	111260152	8117105	165,16
1600	111260153	8117106	221,52

Sisäliitin pitkä kanavalle NIL-ZM



Tuotekoodi	LVI-koodi	Hinta €/kpl
111260160	8117107	53,90
111260161	8117108	54,32
111260162	8117109	55,50
111260163	8117110	56,49
111260164	8117111	63,72
111260165	8117112	67,81
111260166	8117113	77,00
111260167	8117114	93,01
111260168	8117115	103,63
111260169	8117116	185,72
111260170	8117117	249,13
111260171	8117118	282,82
111260172	8118254	358,13

Pitkä sisä-ulkoliitin NILM-ZM

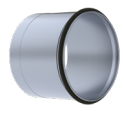

Tuotekoodi	LVI-koodi	Hinta €/kpl
111260175	8117133	66,71
111260176	8117134	67,39
111260177	8117135	68,43
111260178	8117136	69,61
111260179	8117137	73,62
111260180	8117138	77,42
111260181	8117139	85,50

Ulkoliitin NM-ZM



Koko ød	Tuotekoodi	LVI-koodi	Hinta €/kpl
80	111260185	8117119	48,90
100	111260186	8117120	4,59
125	111260187	8117121	4,90
160	111260188	8117122	5,20
200	111260189	8117123	5,58
250	111260190	8117124	11,21
315	111260191	8117125	13,10
400	111260192	8117126	39,60
500	111260193	8117127	43,88
630	111260194	8117128	47,40
800	111260195	8117129	82,80
1000	111260196	8117130	99,12
1250	111260197	8117131	110,40
1600	111260198	8117132	149,01

Lähtökaulus tasopinnalle, jyrkkä NSK-ZM



Tuotekoodi	LVI-koodi	Hinta €/kpl
111260200	8117140	110,02
111260201	8117141	15,54
111260202	8117142	15,99
111260203	8117143	16,53
111260204	8117144	16,94
111260205	8117145	19,00
111260206	8117146	20,59
111260207	8117147	67,83
111260208	8117148	71,64
111260209	8117149	75,72
111260210	8117150	243,95
111260211	8117151	259,75
111260212	8117152	274,85
111260213	8117153	376,02

Lähtökaulus tasopinnalle (osalle) NSKM-ZM



Tuotekoodi	LVI-koodi	Hinta €/kpl
111260220	8117154	76,61
111260221	8117155	38,40
111260222	8117156	39,00
111260223	8117157	39,60
111260224	8117158	40,21
111260225	8117159	41,51
111260226	8117160	42,31
111260227	8117161	46,32
111260228	8117162	47,91
111260229	8117163	50,72
111260230	8117164	112,52
111260231	8117165	126,02
111260232	8117166	139,23
111260233	8118255	181,54

Lähtökaulus pyöreälle NPSV-ZM



Koko Ød1-d2	Tuotekoodi	LVI-koodi	Hinta €/kpl
400/400	111260356	8117376	105,37
500/400	111260360	8117377	108,76
500/500	111260361	8117378	122,97
630/400	111260364	8117379	111,32
630/500	111260365	8117380	127,38
630/630	111260366	8117381	155,10
800/400	111260369	8117382	163,97
800/500	111260370	8117383	174,62
800/630	111260371	8117384	208,88
800/800	111260372	8117385	342,05
1000/400	111260376	8117386	160,76
1000/500	111260377	8117387	177,09
1000/630	111260378	8117388	207,73
1000/800	111260379	8117389	346,31

Koko Ød1-d2	Tuotekoodi	LVI-koodi	Hinta €/kpl
1000/1000	111260380	8117390	453,56
1250/400	111260381	8117391	165,75
1250/500	111260382	8117392	183,79
1250/630	111260383	8117393	211,11
1250/800	111260384	8117394	359,55
1250/1000	111260385	8117395	461,90
1250/1250	111260386	8117396	550,93
1600/400	111260387	8118309	155,43
1600/500	111260388	8118310	180,30
1600/630	111260389	8118311	307,13
1600/800	111260390	8118312	513,56
1600/1000	111260391	8118313	711,27
1600/1250	111260392	8118314	851,78
1600/1600	111260393	8118315	1155,20

Pyöreä kanavajärjestelmä, Magnelis (ZM310)

Lähtökaulus,
lyhyt kaulus
NPSK-ZM



Koko Ød1-d2	Tuotekoodi	LVI-koodi	Hinta €/kpl
100/100	111260242	8117325	21,57
125/100	111260244	8117326	61,27
125/125	111260245	8117327	63,20
160/100	111260247	8117328	60,37
160/125	111260248	8117329	22,11
160/160	111260249	8117330	63,05
200/100	111260251	8117331	21,04
200/125	111260252	8117332	22,82
200/160	111260253	8117333	23,45
200/200	111260254	8117334	28,23
250/100	111260255	8117335	24,32
250/125	111260256	8117336	25,39
250/160	111260257	8117337	26,17
250/200	111260258	8117338	29,91
250/250	111260259	8117339	35,52
315/100	111260260	8117340	23,98
315/125	111260261	8117341	24,96
315/160	111260262	8117342	26,17
315/200	111260263	8117343	29,74
315/250	111260264	8117344	33,82
315/315	111260265	8117345	39,88
400/100	111260266	8117346	60,27
400/125	111260267	8117347	61,09
400/160	111260268	8117348	62,33
400/200	111260269	8117349	65,88
400/250	111260270	8117350	69,61
400/315	111260271	8117351	73,51
400/400	111260272	8118261	66,58
500/100	111260273	8117352	60,27
500/125	111260274	8117353	60,98
500/160	111260275	8117354	62,14
500/200	111260276	8117355	65,77
500/250	111260277	8117356	69,34
500/315	111260278	8117357	72,62
500/400	111260279	8118262	62,75
500/500	111260280	8118263	74,17
630/100	111260281	8117358	60,19
630/125	111260282	8117359	60,92
630/160	111260283	8117360	62,14
630/200	111260284	8117361	65,69
630/250	111260285	8117362	69,16
630/315	111260286	8117363	72,07

Koko Ød1-d2	Tuotekoodi	LVI-koodi	Hinta €/kpl
630/400	111260287	8118264	61,81
630/500	111260288	8118265	89,53
630/630	111260289	8118266	111,91
800/160	111260290	8117364	107,32
800/200	111260291	8117365	110,53
800/250	111260292	8117366	114,34
800/315	111260293	8117367	117,28
800/400	111260294	8118267	93,20
800/500	111260295	8118268	130,57
800/630	111260296	8118269	143,00
800/800	111260297	8118270	271,11
1000/160	111260299	8117368	107,32
1000/200	111260300	8117369	110,71
1000/250	111260301	8117370	113,81
1000/315	111260302	8117371	116,90
1000/400	111260303	8118272	93,20
1000/500	111260304	8118273	129,32
1000/630	111260305	8118274	139,29
1000/800	111260306	8118275	251,19
1000/1000	111260298	8118271	261,51
1250/160	111260309	8117372	115,59
1250/200	111260310	8117373	110,79
1250/250	111260311	8117374	114,26
1250/315	111260312	8117375	116,90
1250/400	111260313	8118278	93,20
1250/500	111260314	8118279	128,08
1250/630	111260315	8118280	138,02
1250/800	111260316	8118281	246,21
1250/1000	111260307	8118276	300,92
1250/1250	111260308	8118277	411,60
1600/160	111260319	8118284	104,44
1600/200	111260321	8118286	109,43
1600/250	111260322	8118287	113,16
1600/315	111260323	8118288	116,89
1600/400	111260324	8118289	126,84
1600/500	111260325	8118290	134,30
1600/630	111260326	8118291	145,49
1600/800	111260327	8118292	253,65
1600/1000	111260317	8118282	299,67
1600/1250	111260318	8118283	361,86
1600/1600	111260320	8118285	605,59

Ilmanvaihtokanavajärjestelmät

Pyöreä kanavajärjestelmä, Magnelis (ZM310)

T-yhde NTK-ZM



Koko Ød1-d2	Tuotekoodi	LVI-koodi	Hinta €/kpl
100/100	111260402	8117397	81,51
125/100	111260404	8117398	123,00
125/125	111260405	8117399	125,32
160/100	111260407	8117401	123,62
160/125	111260408	8117402	84,71
160/160	111260409	8117403	127,81
200/100	111260411	8117405	84,83
200/125	111260412	8117406	87,00
200/160	111260413	8117407	89,02
200/200	111260414	8117408	95,21
250/100	111260415	8117409	98,11
250/125	111260416	8117410	99,71
250/160	111260417	8117411	102,49
250/200	111260418	8117412	108,12
250/250	111260419	8117413	119,91
315/100	111260420	8117414	105,60
315/125	111260421	8117415	107,30
315/160	111260422	8117416	110,80
315/200	111260423	8117417	116,90
315/250	111260424	8117418	122,91
315/315	111260425	8117419	130,91
400/100	111260426	8117420	159,61
400/125	111260427	8117421	161,72
400/160	111260428	8117422	166,72
400/200	111260429	8117423	174,22
400/250	111260430	8117424	180,92
400/315	111260431	8117425	187,83
500/100	111260432	8117426	176,03

Koko Ød1-d2	Tuotekoodi	LVI-koodi	Hinta €/kpl
500/125	111260433	8117427	178,23
500/160	111260434	8117428	184,12
500/200	111260435	8117429	192,64
500/250	111260436	8117430	199,92
500/315	111260437	8117431	206,92
630/100	111260438	8117432	191,92
630/125	111260439	8117433	194,11
630/160	111260440	8117434	200,81
630/200	111260441	8117435	210,51
630/250	111260442	8117436	218,52
630/315	111260443	8117437	226,22
800/160	111260444	8117438	325,51
800/200	111260445	8117439	335,24
800/250	111260446	8117440	346,64
800/315	111260447	8117441	358,45
1000/160	111260448	8117442	368,83
1000/200	111260449	8117443	382,43
1000/250	111260450	8117444	397,35
1000/315	111260451	8117445	414,55
1250/160	111260452	8117446	415,02
1250/200	111260453	8117447	431,73
1250/250	111260454	8117448	431,16
1250/315	111260455	8117449	451,35
1600/160	111260456	8118319	486,18
1600/200	111260457	8118320	507,35
1600/250	111260458	8118321	530,98
1600/315	111260459	8118322	557,09

T-yhde NTKV-ZM



Koko Ød1-d2	Tuotekoodi	LVI-koodi	Hinta €/kpl
400/400	111260470	8117450	258,94
500/400	111260471	8117451	272,43
500/500	111260472	8117452	288,03
630/400	111260473	8117453	295,64
630/500	111260474	8117454	314,35
630/630	111260475	8117455	345,63
800/400	111260476	8117456	623,77
800/500	111260477	8117457	649,68
800/630	111260478	8117458	688,67
800/800	111260479	8117459	831,19
1000/400	111260481	8117460	695,27
1000/500	111260482	8117461	723,88
1000/630	111260483	8117462	764,29
1000/800	111260484	8117463	916,59

Koko Ød1-d2	Tuotekoodi	LVI-koodi	Hinta €/kpl
1000/1000	111260480	8117464	1033,49
1250/400	111260487	8117465	786,29
1250/500	111260488	8117466	810,47
1250/630	111260489	8117467	845,58
1250/800	111260490	8117468	1019,60
1250/1000	111260485	8117469	1132,41
1250/1250	111260486	8117470	1240,13
1600/400	111260494	8118326	966,18
1600/500	111260495	8118327	1002,24
1600/630	111260496	8118328	1142,76
1600/800	111260497	8118329	1370,32
1600/1000	111260491	8118323	1641,40
1600/1250	111260492	8118324	1760,76
1600/1600	111260493	8118325	2099,02

Pyöreä kanavajärjestelmä, Magnelis (ZM310)

Muunto keskeinen, osakoko NFCV-ZM



Koko Ød1-d2	Tuotekoodi	LVI-koodi	Hinta €/kpl
125/100	111260501	8117170	119,27
160/100	111260503	8117171	32,77
160/125	111260504	8117172	32,77
200/100	111260506	8117173	34,55
200/125	111260507	8117174	35,40
200/160	111260508	8117175	35,40
250/100	111260509	8117176	78,66
250/125	111260510	8117177	41,95
250/160	111260511	8117178	41,24
250/200	111260512	8117179	40,64
315/125	111260513	8117180	85,20
315/160	111260514	8117181	48,50
315/200	111260515	8117182	47,18
315/250	111260516	8117183	47,18
400/125	111260517	8118330	160,98
400/160	111260518	8117184	102,25
400/200	111260519	8117185	100,93
400/250	111260520	8117186	99,63
400/315	111260521	8117187	95,69
500/125	111260522	8118331	186,35
500/160	111260523	8118332	109,61
500/200	111260524	8117188	116,67
500/250	111260525	8117189	115,36
500/315	111260526	8117190	111,42
500/400	111260527	8117191	108,78
630/160	111260528	8118333	127,16
630/200	111260529	8118334	120,45
630/250	111260530	8117192	133,68
630/315	111260531	8117193	136,33
630/400	111260532	8117194	138,95
630/500	111260533	8117195	133,68
800/315	111260534	8118335	265,63
800/400	111260535	8117196	319,84
800/500	111260536	8117197	321,15
800/630	111260537	8117198	304,11
1000/315	111260538	8118336	337,90
1000/400	111260539	8117199	382,74
1000/500	111260540	8117200	388,00
1000/630	111260541	8117201	394,54
1000/800	111260542	8117202	464,02
1250/400	111260544	8118337	443,04
1250/500	111260545	8117203	500,72
1250/630	111260546	8117204	511,21
1250/800	111260547	8117205	589,86
1250/1000	111260543	8117206	545,28
1600/800	111260550	8118340	757,29
1600/1000	111260548	8118338	703,81
1600/1250	111260549	8118339	707,54

Muunto keskeinen, osakoko NFCVM- H



Koko Ød1-d2	Tuotekoodi	LVI-koodi	Hinta €/kpl
125/100	111260561	8117210	115,36
160/100	111260563	8117211	30,15
160/125	111260564	8117212	30,40
200/100	111260566	8117213	31,46
200/125	111260567	8117214	32,77
200/160	111260568	8117215	32,77
250/100	111260569	8117216	74,72
250/125	111260570	8117217	38,01
250/160	111260571	8117218	38,01
250/200	111260572	8117219	36,70
315/125	111260573	8117220	81,25
315/160	111260574	8117221	44,56
315/200	111260575	8117222	43,25
315/250	111260576	8117223	43,25
400/160	111260577	8117224	95,69
400/200	111260578	8117225	94,38
400/250	111260579	8117226	93,07
400/315	111260580	8117227	89,13
500/200	111260581	8117228	108,78
500/250	111260582	8117229	108,78
500/315	111260583	8117230	104,84
500/400	111260584	8117231	100,93
630/250	111260585	8117232	125,84
630/315	111260586	8117233	128,47
630/400	111260587	8117234	131,09
630/500	111260588	8117235	125,84
800/400	111260589	8117236	262,16
800/500	111260590	8117237	264,77
800/630	111260591	8117238	247,75
1000/400	111260592	8117239	322,45
1000/500	111260593	8117240	327,70
1000/630	111260594	8117241	334,25
1000/800	111260595	8117242	403,71
1250/500	111260597	8117243	439,10
1250/630	111260598	8117244	449,59
1250/800	111260599	8117245	528,24
1250/1000	111260596	8117246	483,68
1600/800	111260602	8118343	846,82
1600/1000	111260600	8118341	793,35
1600/1250	111260601	8118342	634,17

Ilmanvaihtokanavajärjestelmät

Pyöreä kanavajärjestelmä, Magnelis (ZM310)

Muunto keskeinen,
osakoko
NFB-ZM



Koko Ød1-d2	Tuotekoodi	LVI-koodi	Hinta €/kpl
125/100	111260611	8117250	130,91
160/100	111260613	8117251	79,38
160/125	111260614	8117252	79,38
200/100	111260616	8117253	82,18
200/125	111260617	8117254	82,18
200/160	111260618	8117255	82,18
250/100	111260619	8117256	86,35
250/125	111260620	8117257	86,35
250/160	111260621	8117258	86,35
250/200	111260622	8117259	84,95
315/125	111260623	8117260	93,30
315/160	111260624	8117261	93,30
315/200	111260625	8117262	91,92
315/250	111260626	8117263	91,92
400/125	111260627	8118344	104,91
400/160	111260628	8117264	111,42
400/200	111260629	8117265	108,63
400/250	111260630	8117266	107,26
400/315	111260631	8117267	104,44
500/125	111260632	8118345	119,58
500/160	111260633	8118346	114,19
500/200	111260634	8117268	125,34
500/250	111260635	8117269	123,94
500/315	111260636	8117270	119,77
500/400	111260637	8117271	123,94
630/160	111260638	8118347	142,01
630/200	111260639	8118348	137,39
630/250	111260640	8117272	147,64
630/315	111260641	8117273	146,25
630/400	111260642	8117274	146,25
630/500	111260643	8117275	140,68
800/315	111260644	8118349	312,81
800/400	111260645	8117276	339,82
800/500	111260646	8117277	338,44
800/630	111260647	8117278	320,32
1000/315	111260648	8118350	394,52
1000/400	111260649	8117279	417,81
1000/500	111260650	8117280	415,02
1000/630	111260651	8117281	412,24
1000/800	111260652	8117282	484,65
1250/400	111260654	8118351	491,59
1250/500	111260655	8118352	484,25
1250/630	111260656	8117283	536,18
1250/800	111260657	8117284	610,00
1250/1000	111260653	8117285	564,05
1600/800	111260660	8118355	686,50
1600/1000	111260658	8118353	629,39
1600/1250	111260659	8118354	743,33

Muunto keskeinen,
osakoko
NFBM- H



Koko Ød1-d2	Tuotekoodi	LVI-koodi	Hinta €/kpl
125/100	111260671	8117288	79,38
160/100	111260673	8117290	84,95
160/125	111260674	8117291	82,18
200/100	111260676	8117292	94,70
200/125	111260677	8117293	91,92
200/160	111260678	8117294	86,35
250/100	111260679	8117295	110,02
250/125	111260680	8117296	107,26
250/160	111260681	8117297	100,26
250/200	111260682	8117298	93,30
315/125	111260683	8117299	132,30
315/160	111260684	8117300	126,73
315/200	111260685	8117301	116,99
315/250	111260686	8117302	107,26
400/160	111260687	8117303	186,63
400/200	111260688	8117304	174,10
400/250	111260689	8117305	158,76
400/315	111260690	8117306	135,07
500/200	111260691	8117307	245,11
500/250	111260692	8117308	227,02
500/315	111260693	8117309	199,16
500/400	111260694	8117310	172,70
630/250	111260695	8117311	298,04
630/315	111260696	8117312	292,47
630/400	111260697	8117313	275,75
630/500	111260698	8117314	228,38
800/400	111260699	8117315	465,14
800/500	111260700	8117316	458,19
800/630	111260701	8117317	431,73
1000/400	111260702	8117318	349,56
1000/500	111260703	8117319	849,54
1000/630	111260704	8117320	814,73
1000/800	111260705	8117321	940,31
1250/630	111260707	8117322	1378,77
1250/800	111260708	8117323	1300,78
1250/1000	111260706	8117324	972,10
1600/800	111260711	8118358	2581,46
1600/1000	111260709	8118356	2205,94
1600/1250	111260710	8118357	1982,13

Pyöreä kanavajärjestelmä, Magnelis (ZM310)

Tulppa kanavalle NAL-ZM



Koko Ød	Tuotekoodi	LVI-koodi	Hinta €/kpl
100	111260721	8117484	22,29
125	111260722	8117485	22,63
160	111260723	8117486	23,59
200	111260724	8117487	24,90
250	111260725	8117488	27,53
315	111260726	8117489	30,15
400	111260727	8117490	76,02
500	111260728	8117491	82,59
630	111260729	8117492	90,44
800	111260730	8117493	255,60
1000	111260731	8117494	293,60
1250	111260732	8117495	331,63
1600	111260733	8118359	427,76

Tulppa osalle NALM-ZM



Tuotekoodi	LVI-koodi	Hinta €/kpl
111260781	8117497	21,49
111260782	8117498	22,29
111260783	8117499	22,29
111260784	8117500	23,59
111260785	8117501	26,23
111260786	8117502	27,61
111260787	8117503	69,47
111260788	8117504	74,72
111260789	8117505	83,91
111260790	8117506	197,93
111260791	8117507	234,63
111260792	8117508	270,02
111260793	8118362	354,39

Tulppa-puhdistusluukku kanavalle NALH-ZM



Tuotekoodi	LVI-koodi	Hinta €/kpl
111260741	8318737	52,43
111260742	8318738	52,43
111260743	8318739	53,74
111260744	8318740	53,99
111260745	8318741	57,68
111260746	8318742	66,85
111260747	8318743	245,11
111260748	8318744	251,68
111260749	8318745	260,85
111260750	8318746	292,31
111260751	8318747	330,31
111260752	8318748	368,31
111260753	8118361	455,75

Tulppa-puhdistusluukku osalle NALMH-ZM



Koko Ød	Tuotekoodi	LVI-koodi	Hinta €/kpl
100	111260801	8318749	51,53
125	111260802	8318750	51,53
160	111260803	8318751	51,53
200	111260804	8318752	52,91
250	111260805	8318753	52,91
315	111260806	8318754	61,28
400	111260807	8318755	104,44
500	111260808	8318756	107,26
630	111260809	8318757	114,20
800	111260810	8318758	182,45
1000	111260811	8318759	211,69
1250	111260812	8318760	243,72
1600	111260813	8118364	299,51

Tulppa-puhdistusluukku kanavalle, EI 60 NALHE-ZM



Tuotekoodi	LVI-koodi	Hinta €/kpl
111260760	8318761	124,01
111260761	8318762	135,17
111260762	8318763	157,16
111260763	8318764	170,44
111260764	8318765	202,42
111260765	8318766	289,73
111260766	8318767	356,86
111260767	8318768	455,47
111260768	8318769	533,88
111260769	8318770	744,49
111260770	8318771	842,65
111260771	8318772	931,04

Tulppa-puhdistusluukku osalle, EI 60 NALMHE-ZM



Tuotekoodi	LVI-koodi	Hinta €/kpl
111260820	8118365	67,92
111260821	8118366	69,67
111260822	8118367	75,18
111260823	8118368	89,01
111260824	8118369	84,65
111260825	8118370	104,78
111260826	8118371	114,85
111260827	8118372	181,50
111260828	8118373	213,04
111260829	8118374	376,64
111260830	8118375	502,22
111260831	8118376	619,87

Ilmanotto suojaverkolla (suora) NG-ZM



Koko Ød	Tuotekoodi	LVI-koodi	Hinta €/kpl
100	111260871	8118405	78,35
125	111260872	8118406	80,83
160	111260873	8118407	82,08
200	111260874	8118408	83,31
250	111260875	8118409	90,77
315	111260876	8118410	95,76
400	111260877	8118411	187,76
500	111260878	8118412	196,48
630	111260879	8118413	211,40
800	111260880	8118414	239,98
1000	111260881	8118415	277,30
1250	111260882	8118416	323,32
1600	111260883	8118417	443,92

Imukartio suojaverkolla NK-ZM

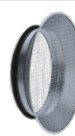

Tuotekoodi	LVI-koodi	Hinta €/kpl
111260891	8117471	93,30
111260892	8117472	96,09
111260893	8117473	100,26
111260894	8117474	105,85
111260895	8117475	114,20
111260896	8117476	121,16
111260897	8117477	227,02
111260898	8117478	239,54
111260899	8117479	259,05
111260900	8117480	296,65
111260901	8117481	362,11
111260902	8117482	428,95

Ulostulo viisteinen, verkko NP-ZM

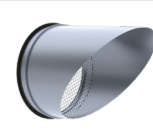

Tuotekoodi	LVI-koodi	Hinta €/kpl
111260911	8118420	198,16
111260912	8118421	199,64
111260913	8118422	202,59
111260914	8118423	205,97
111260915	8118424	223,89
111260916	8118425	232,14
111260917	8118426	255,25
111260918	8118427	284,26
111260919	8118428	332,49
111260920	8118429	417,64
111260921	8118430	582,98
111260922	8118431	748,96
111260923	8118432	1192,54

12. Pyöreä kanavajärjestelmä, haponkestävä

**Kierresaumakanava,
pituus 3 m
NTO-H**



Koko ød	Tuotekoodi	LVI-koodi	Hinta €/m
100	H10101013O	8103798	79,32
125	H10101123O	8103799	96,42
160	H10101163O	8103800	115,10
200	H10101203O	8103801	149,32
250	H10101253O	8103802	175,76
315	H10101313O	8103804	231,12
400	H10101403O	8103806	385,74
500	H10101503O	8103807	474,41
630	H10101633O	8103808	580,16
800	H10101803O	8103809	732,60
1000	H10101100O	8103810	1003,24
1250	H101012503O	8103811	1225,65

**Kierresaumakanava,
pituus 6 m
NTO-H**



Koko ød	Tuotekoodi	LVI-koodi	Hinta €/m
100	H10101016O	8103848	79,32
125	H10101126O	8103849	96,42
160	H10101166O	8103850	115,10
200	H10101206O	8103851	149,32
250	H10101256O	8103852	175,76
315	H10101316O	8103854	231,12
400	H10101406O	8103856	385,74
500	H10101506O	8103857	474,41
630	H10101636O	8103858	580,16
800	H10101806O	8103859	732,60
1000	H10101106O	8103860	1003,24
1250	H101012506O	8103861	1225,65

**Sisäliitin
NI-H**



Koko ød	Tuotekoodi	LVI-koodi	Hinta €/m
100	H10203010	8114090	51,88 •
125	H10203120	8114091	56,72 •
160	H10203160	8114092	59,35 •
200	H10203200	8114093	64,33 •
250	H10203250	8114094	69,45 •
315	H10203310	8114095	74,42 •
400	H10203400	8114096	113,46 •
500	H10203500	8114097	133,65
630	H10203630	8114098	209,33
800	H10203800	8114099	361,67
1000	H10203100	8114100	509,03
1250	H10203125	8114101	704,24

**Käyrä 90°
NV-H**



Koko ød	Tuotekoodi	LVI-koodi	Hinta €/kpl
100	H10202019	8114001	121,07 •
125	H10202129	8114002	138,77 •
160	H10202169	8114003	146,38 •
200	H10202209	8114004	199,93 •
250	H10202259	8114005	230,09 •
315	H10202319	8114006	302,72 •
400	H10202409	8114007	408,29 •
500	H10202509	8114008	530,33
630	H10202639	8114009	910,52
800	H10202809	8114010	1650,74
1000	H10202109	8114011	2984,09
1250	H10202125-9	8114012	4359,64

**Käyrä 45°
NV-H**



Tuotekoodi	LVI-koodi	Hinta €/kpl
H10202014	8114016	80,32 •
H10202124	8114017	92,44 •
H10202164	8114018	109,40 •
H10202204	8114019	132,09 •
H10202254	8114020	155,38 •
H10202314	8114021	188,59 •
H10202404	8114022	248,13
H10202504	8114023	350,34
H10202634	8114024	462,86
H10202804	8114025	951,59
H10202104	8114026	1807,11
H10202125-4	8114027	2627,58

**Ulkoliitin
NM-H**



Tuotekoodi	LVI-koodi	Hinta €/kpl
H10204010	8114105	25,23
H10204120	8114106	28,39
H10204160	8114107	31,54
H10204200	8114108	37,23
H10204250	8114109	43,18
H10204310	8114110	55,46
H10204400	8114111	89,66
H10204500	8114112	98,38
H10204630	8114113	122,31
H10204800	8114114	185,27
H10204100-0	8114115	273,18
H10204125	8114116	327,38

**Lähtökaulus
tasopinnalle, jyrkkä
NSK-H**



Koko ød	Tuotekoodi	LVI-koodi	Hinta €/kpl
100	H10205100	8114121	37,91
125	H10205125	8114122	40,40
160	H10205160	8114123	49,27
200	H10205200	8114124	54,37
250	H10205250	8114125	59,35
315	H10205310	8114126	66,97
400	H10205400	8114127	86,75
500	H10205500	8114128	105,99
630	H1020630	8114129	151,50
800	H10205800	8114130	291,60
1000	H102051000	8114131	366,51
1250	H102051250	8114132	536,83

**Tulppa
kanavalle
NAL-H**



Tuotekoodi	LVI-koodi	Hinta €/kpl
H10208010	8114136	83,32
H10208120	8114137	84,90
H10208160	8114138	86,60
H10208200	8114139	98,52
H10208250	8114140	107,78
H10208310	8114141	127,02
H10208400	8114142	170,46
H10208500	8114143	211,82
H10208630	8114144	276,03
H10208800	8114145	390,45
H10208100	8114146	656,79
H10208150	8114147	966,84

**Tulppa osalle
NALM-H**



Tuotekoodi	LVI-koodi	Hinta €/kpl
H10208010-1	8114151	80,56
H10208120-1	8114152	82,19
H10208160-0	8114153	83,84
H10208200-1	8114154	88,26
H10208250-1	8114155	97,55
H10208310-1	8114156	107,64
H10208400-1	8114157	154,16
H10208500-1	8114158	181,28
H10208630-1	8114159	216,68
H10208800-1	8114160	351,37
H10201000-1	8114161	816,87
H10201000-2	8114162	1012,78

Pyöreä kanavajärjestelmä, haponkestävä

Muunto keskeinen, osakoko NFCV-H



Koko Ød1-d2	Tuotekoodi	LVI-koodi	Hinta €/kpl
125/100	H10209121-0	8114702	107,23
160/100	H10209160-1	8114704	130,70
160/125	H10209161-2	8114705	130,70
200/100	H10209201-0	8114707	156,52
200/125	H10209201-2	8114708	156,52
200/160	H10209200-2	8114709	156,52
250/100	H10209251-0	8114711	175,67
250/125	H10209252-1	8114712	175,67
250/160	H10209251-6	8114713	175,67
250/200	H10209252-0	8114714	175,67
315/100	H10209311-0	8114716	198,03
315/125	H10209311-2	8114717	198,03
315/160	H10209311-6	8114718	198,03
315/200	H10209312-0	8114719	198,03
315/250	H10209312-5	8114720	198,03
400/100	H10209401-0	8114722	246,34
400/125	H10209401-2	8114723	246,34
400/160	H10209401-6	8114724	246,34
400/200	H10209402-0	8114725	246,34
400/250	H10209402-5	8114726	246,34
400/315	H10209403-1	8114727	246,34
500/100	H10209501-0	8114729	302,66
500/125	H10209501-2	8114730	302,66
500/160	H10209501-6	8114731	302,66
500/200	H10209502-0	8114732	302,66
500/250	H10209502-5	8114733	302,66
500/315	H10209503-1	8114734	302,66
500/400	H10209504-0	8114735	302,66
630/100	H10209631-0	8114737	474,88
630/125	H10209631-2	8114738	474,88
630/160	H10209631-6	8114739	474,88
630/200	H10209632-0	8114740	474,88
630/250	H10209632-5	8114741	474,88
630/315	H10209633-1	8114742	474,88
630/400	H10209634-0	8114743	474,88
630/500	H10209635-0	8114744	474,88
800/400	H102098040	8114752	718,45
800/500	H10209805-0	8114753	701,79
800/630	H10209806-0	8114754	701,79
1000/400	111023079	8114762	1102,27
1000/500	H10209100-5	8114763	1102,27
1000/630	H10209106-0	8114764	1102,27
1000/800	H10209108-0	8114765	1102,27
1250/500	111023085	8114774	1542,43
1250/630	111023086	8114775	2023,75
1250/800	111023087	8114776	1806,93
1250/1000	H102121000	8114777	2041,64

Muunto epäkeskeinen, osakoko NFB- H



Koko Ød1-d2	Tuotekoodi	LVI-koodi	Hinta €/kpl
125/100	111025002	8114202	111,31
160/100	111025004	8114204	118,59
160/125	H10209161-3	8114205	132,82
200/100	H10209200-1	8114207	147,22
200/125	111025008	8114208	131,45
200/160	H10209201-6	8114209	132,92
250/100	111025010	8114211	154,54
250/125	111025011	8114212	177,92
250/160	111025012	8114213	158,85
250/200	10209252-2	8114214	175,67
315/100	1020931100-2	8114216	177,17
315/125	1020931125-2	8114217	179,24
315/160	1020931160-2	8114218	198,03
315/200	1020931200-2	8114219	221,79
315/250	1020931250-2	8114220	198,03
400/125	1020940125	8114223	240,39
400/160	10209504-4	8114224	277,74
400/200	10209402-1	8114225	247,97
400/250	10209415-1	8114226	277,74
400/315	10209403-2	8114227	277,74
500/125	1020950125	8114230	283,77
500/160	1020950160	8114231	300,44
500/200	1020950200	8114232	358,76
500/250	10209504-3	8114233	320,32
500/315	1020950315	8114234	332,93
500/400	10209504-2	8114235	347,57
630/160	1020963160	8114239	371,72
630/200	1020963200	8114240	416,95
630/250	1020963250	8114241	382,82
630/315	1020963315	8114242	390,34
630/400	1020963400	8114243	462,51
630/500	10209635-2	8114244	474,88
800/315	1020980315	8114251	651,89
800/400	1020980400	8114252	718,45
800/500	1020980500	8114253	757,38
800/630	10209806-4	8114254	848,25
1000/400	111025094	8114262	983,70
1000/500	1020910500	8114263	1102,27
1000/630	1020910630	8114264	1239,77
1000/800	10209108-1	8114265	1388,55
1250/500	H10209125-1	8114274	1542,43
1250/630	1020912630	8114275	1780,84
1250/800	1020912800	8114276	1806,93
1250/1000	1020912100	8114277	1705,99

Ilmanvaihtokanavajärjestelmät

Pyöreä kanavajärjestelmä, haponkestävä

Lähtökaulus,
lyhyt kaulus
NPSK-H



Koko Ød1-d2	Tuotekoodi	LVI-koodi	Hinta €/kpl
100/100	H10206101-0	8114302	105,70
125/100	H10206101-2	8114303	118,01
125/125	H10206101-3	8114304	120,37
160/100	H10206161-4	8114305	153,01
160/125	H10206161-2	8114306	156,06
160/160	H10206160-0	8114307	161,19
200/100	H10206201-0	8114905	171,44
200/125	H10206201-2	8118960	176,54
200/160	H10206201-6	8114309	192,05
200/200	H10206202-0	8114310	197,15
250/100	H10206251-0	8114906	206,29
250/125	H10206251-2	8114907	216,66
250/160	H10206251-6	8114311	225,80
250/200	H10206252-0	8114312	231,04
250/250	H10206251-5	8114313	329,98
315/100	H10206311-0	8114908	261,56
315/125	H10206311-2	8114909	266,89
315/160	H10206311-6	8114314	272,24
315/200	H10206312-0	8114315	278,63
315/250	H10206312-5	8114316	284,33
315/315	H10206313-1	8114317	290,01
400/100	H10206401-0	8114910	251,52
400/125	H10206401-2	8114911	256,65
400/160	H10206401-6	8114912	271,58
400/200	H10206402-0	8114318	277,12
400/250	H10206402-5	8114319	306,85
400/315	H10206403-1	8114320	313,10

Koko Ød1-d2	Tuotekoodi	LVI-koodi	Hinta €/kpl
400/400	H10206404-K	8114963	359,31
500/100	H10206501-0	8114913	311,86
500/125	H10206501-2	8114914	318,22
500/160	H10206501-6	8114915	400,42
500/200	H10206502-0	8114916	452,74
500/250	H10206502-5	8114968	461,98
500/315	H10206503-1	8114964	492,99
500/400	H10206504-K	8114965	503,07
630/100	H10206631-0	8114918	402,43
630/125	H10206631-2	8114919	410,64
630/160	H10206631-6	8114920	472,81
630/200	H10206632-0	8114921	482,47
630/250	H10206632-5	8114922	492,10
630/315	H10206633-1	8114966	568,39
630/400	H10206604-1	8114967	579,98
800/160	H10206802-0	8114925	513,08
800/200	H10206803-2	8114926	523,55
800/250	H10206803-4	8114927	608,67
800/315	H10206803-5	8114928	621,09
800/400	111027092	8114929	769,82
1000/160	H10206104-1	8114933	631,32
1000/200	111027097	8114934	599,20
1000/250	111027098	8114935	752,55
1000/315	111027099	8114936	826,40
1250/250	111027107	8114944	769,96
1250/315	111027108	8114945	872,62

Lähtökaulus pyöreälle
NPSV-H



Koko Ød1-d2	Tuotekoodi	LVI-koodi	Hinta €/kpl
400/400	H10206404-0	8114321	461,98
500/400	H10206504-0	8114324	564,63
500/500	H10206505-0	8114325	621,09
630/400	H10206634-0	8114327	769,96
630/500	H10206635-0	8114328	800,82
630/630	H10206636-3	8114329	831,52
800/400	H10206804-2	8114330	975,28
800/500	H10206806-5	8114331	1437,25
800/630	H10206806-6	8114332	1539,91
800/800	H10206806-7	8114333	1833,25
1000/400	H10206100-4	8114359	1834,17
1000/500	H10206100-5	8114334	1180,60
1000/630	H10206100-6	8114335	1231,93
1000/800	H10206100-8	8114336	1334,59
1000/1000	H10206100-1	8114337	1385,92
1250/400	H10206168-5	8114361	1077,94
1250/500	111028067	8114362	1129,27
1250/630	H10206156-3	8114338	1324,36
1250/800	111028069	8114339	1401,27
1250/1000	111028070	8114340	1632,34
1250/1250	111028071	8114341	2032,75

T-yhde
NTKV-H



Koko Ød1-d2	Tuotekoodi	LVI-koodi	Hinta €/kpl
400/400	H10207401-4	8114445	508,18
500/400	H10207501-4	8114453	728,86
500/500	H10207500-5	8114454	737,94
630/400	H10207630-4	8114462	1217,34
630/500	H10207630-5	8114463	1242,16
630/630	H10207630-6	8114464	1267,01
800/400	H10207802-3	8114472	1418,55
800/500	H10207802-5	8114473	1447,49
800/630	H10207802-6	8114474	1476,45
800/800	H10207802-8	8114475	1515,62
1000/500	H10207508-7	8114484	2042,97
1000/630	H10207508-8	8114485	2364,28
1000/800	H102100080	8114486	2412,55
1000/1000	H10207100-1	8114487	2577,42
1250/400	H10207509-8	8114495	3672,18
1250/500	H10207509-5	8114496	3747,11
1250/630	H10207510	8114497	3923,71
1250/800	H102125080	8114498	4003,78
1250/1000	H1020101250	8114499	4175,23
1250/1250	H1020101251	8114500	4260,43

Pyöreä kanavajärjestelmä, haponkestävä

T-yhde NTK-H



Koko Ød1-d2	Tuotekoodi	LVI-koodi	Hinta €/kpl
100/100	H10207101-1	8114412	143,77
125/100	H10207121-1	8114414	159,11
125/125	H10207121-2	8114415	162,42
160/100	H10207160-1	8114417	219,37
160/125	H10207160-2	8114418	223,86
160/160	H10207160-6	8114419	228,33
200/100	H10207201-1	8114421	263,59
200/125	H10207201-2	8114422	268,98
200/160	H10207201-6	8114423	274,36
200/200	H10207200-2	8114424	292,64
250/100	H10207250-1	8114426	320,37
250/125	H10207250-2	8114427	327,05
250/160	H10207250-6	8114428	333,73
250/200	H10207251-2	8114429	340,41
250/250	H10207251-5	8114430	347,07
315/100	H10207310-1	8114432	316,88
315/125	H10207310-2	8114433	323,34
315/160	H10207310-6	8114434	366,59
315/200	H10207311-2	8114435	374,23
315/250	H10207311-5	8114436	381,87
315/315	H10207315-1	8114437	389,51
400/100	H10207400-1	8114439	452,74
400/125	H10207400-2	8114440	461,98
400/160	H10207400-6	8114441	488,00
400/200	H10207401-2	8114442	497,95

Koko Ød1-d2	Tuotekoodi	LVI-koodi	Hinta €/kpl
400/250	H10207401-5	8114443	507,92
400/315	H10207401-3	8114444	543,76
500/100	H10207500-1	8114447	653,94
500/125	H10207500-2	8114448	667,29
500/160	H10207500-6	8114449	684,18
500/200	H10207501-2	8114450	698,16
500/250	H10207501-5	8114451	712,11
500/315	H10207501-3	8114452	728,86
630/100	111029073	8114456	855,17
630/125	111029074	8114457	872,62
630/160	H10207160-3	8114458	955,79
630/200	H10207160-4	8114459	975,28
630/250	H10207630-2	8114460	994,79
630/315	H10207630-3	8114461	960,31
800/160	H10207160-5	8114468	1056,36
800/200	H10207800-2	8114469	1077,94
800/250	H10207802-2	8114470	1197,26
800/315	H10207160-7	8114471	1221,69
1000/160	H10207160-8	8114479	1760,64
1000/200	H10207160-9	8114480	1796,56
1000/250	H10207508-3	8114481	1841,18
1000/315	H10207508-2	8114482	1878,76
1250/250	H10207509-6	8114493	3420,67
1250/315	H10207509-7	8114494	3490,46

Tulppa-puhdistusluukku kanavalle NALH-H



Koko Ød	Tuotekoodi	LVI-koodi	Hinta €/kpl
100	H10208100-0	8318792	63,09
125	H102081250-0	8318793	65,71
160	H102081600-0	8318794	69,01
200	H10208200-0	8318795	70,85
250	H10208250-0	8318796	86,91
315	H10208315-0	8318797	107,64
400	H10208400-0	8318798	144,46
500	H10208500-0	8318799	171,02
630	H10208630-0	8318800	213,90
800	H10208800-0	8318801	422,49
1000	111032011	8318802	630,53
1250	111032012	8318803	804,72

Tulppa-puhdistusluukku osalle NALMH-H



Koko Ød	Tuotekoodi	LVI-koodi	Hinta €/kpl
100	H10208100-2	8318804	52,30
125	H10208125-2	8318805	53,35
160	H10208160-2	8318806	69,73
200	H10208200-2	8318807	71,20
250	H10208250-2	8318808	85,70
315	H10208315-2	8318809	88,62
400	H10208400-2	8318810	146,72
500	H10208500-2	8318811	220,80
630	H10208630-2	8318812	277,48
800	H10208800-2	8318813	579,66
1000	H102081000-2	8318814	973,35
1250	H102081250-2	8318815	1263,89

Puhdistusluukku TLP-H



Koko d	Tuotekoodi	LVI-koodi	Hinta €/kpl
100	H10111006	8318816	242,97
125	H10111226	8318817	242,97
160	H10111626	8318818	242,97
200	H10112026	8318819	333,20
250	H10113250	8318820	333,20
315	H10113026	8318821	333,20
400	H10114026	8318822	333,20
500	H10115026	8318823	382,82
630	H10116326	8318824	554,91
800	H10118026	8318825	554,91
1000	H101100026	8318826	554,91
1250	H10111226-0	8318657	554,91

Säätöpelti KROS-H



Koko Ød	Tuotekoodi	LVI-koodi	Hinta €/kpl
100	H6210100	8417165	214,12
125	H6210125	8417166	220,41
160	H6210160	8417167	235,39
200	H6210200	8417168	257,74
250	H62102500	8417169	331,28
315	H6210315	8417170	374,74
400	H6210400	8417171	541,54
500	H6210500	8417172	765,57
630	H6210630	8417173	1082,94

Ilmanvaihtokanavajärjestelmät

13. NORDrect - Suorakaidekanavajärjestelmä

Suorakaidekanava EKT	Käyrä EKP	Käyrä terävällä ulkoreunalla EKPK	S-kappale EKN	Muunto, (suorakaide- suorakaide) EKK	Muunto, (suorakaide-pyöreä) EKD
					
Lähtökaulus tasopinnalle ESS	Lähtökaulus tasopinnalle (kaarevalla sivulla) ESK	Lähtökaulus pyöreälle kanavalle ESD	Lähtökaulus pyöreälle kanavalle ESDR	T-yhde EKM	Pääty EKO
					

Hinnat tarjouksen mukaan.

14. NORDaccessories -Asennus- ja kiinnitystarvikkeet

Koodi	LVI-koodi	Nimi		Hinta €	kpl/ laatikko	
111602017	8331669	Ilmastointisilikoni 310ml ETS NORD	kpl	9,23		
111602014	8132494	FireStop-silikoni 310ml ETS NORD	kpl	16,48		
111610151	8351105	IV-kuilukannake 100 mm	pari	4,60		
111610152	8351106	IV-kuilukannake 125 mm	pari	4,77		
111610153	8351107	IV-kuilukannake 160 mm	pari	5,48		
111610154	8351108	IV-kuilukannake 200 mm	pari	5,85		
111610155	8351109	IV-kuilukannake 250 mm	pari	6,71		
111610156	8351110	IV-kuilukannake 315 mm	pari	7,61		
111610157	8351111	IV-kuilukannake 400 mm	pari	8,27		
111610158	8351112	IV-kuilukannake 500 mm	pari	15,47		
111610159	8351113	IV-kuilukannake 630 mm	pari	19,84		
111610160	8351114	IV-kuilukannake 800 mm	pari	26,55		
111610161	8351115	IV-kuilukannake 1000 mm	pari	29,67		
111610162	8351116	IV-kuilukannake 1250 mm	pari	34,89		
111610163	8351117	IV-kuilukannakkeen jalka	kpl	4,79		
111610164	8351118	IV-kuilukannakkeen putki	kpl	4,20		
111610165	3211860	Kierretanko, ontto 3/4", 2m	kpl	60,16		
111610166	3219149	Runkolevy 3/4"-muhvilla	kpl	2,70		
TA8352810	8338600	I-sanka 100 mm M8 (60 kpl/ltk)	kpl	1,23	60	
TA8352812	8338601	I-sanka 125 mm M8 (60 kpl/ltk)	kpl	1,30	60	
TA8352814	8338602	I-sanka 160 mm M8 (60 kpl/ltk)	kpl	1,55	60	
TA8352816	8338603	I-sanka 200 mm M8 (30 kpl/ltk)	kpl	1,70	30	
TA8352818	8338604	I-sanka 250 mm M8 (30 kpl/ltk)	kpl	2,13	30	
TA8352820	8338605	I-sanka 315 mm M8 (30 kpl/ltk)	kpl	2,65	30	
TA8352822	8338606	I-sanka 400 mm M8 (15 kpl/ltk)	kpl	3,58	15	
70304110	8353010	TK 100 I-sanka	kpl	0,90		
70304112	8353012	TK 125 I-sanka	kpl	1,24		
70304116	8353014	TK 160 I-sanka	kpl	1,27		
70304120	8353016	TK 200 I-sanka	kpl	1,61		
70304125	8353018	TK 250 I-sanka	kpl	1,93		
70304131	8353020	TK 315 I-sanka	kpl	2,51		
70304140	8353022	TK 400 I-sanka	kpl	3,52		
70304150	8353024	TK 500 I-sanka	kpl	4,99		
70304163	8353026	TK 630 I-sanka	kpl	6,67		
70304180	8353028	TK 800 I-sanka	kpl	8,88		
70304111	8353030	TK 1000 I-sanka	kpl	10,03		
703041250	8353032	TK 1250 I-sanka	kpl	11,02		
70304010H	8338608	I-sanka pikalukolla 100 mm M8 HST	pari	19,58		
70304012H	8338609	I-sanka pikalukolla 125 mm M8 HST	pari	23,15		
70304016H	8338610	I-sanka pikalukolla 160 mm M8 HST	pari	26,18		
70304020H	8338611	I-sanka pikalukolla 200 mm M8 HST	pari	31,81		
70304025H	8338612	I-sanka pikalukolla 250 mm M8 HST	pari	38,14		
70304031H	8338613	I-sanka pikalukolla 315 mm M8 HST	pari	45,18		
70304040H	8338614	I-sanka pikalukolla 400 mm M8 HST	pari	54,59		

Ilmanvaihtokanavajärjestelmät

14. NORDaccessories -Asennus- ja kiinnitystarvikkeet

Koodi	LVI-koodi	Nimi		Hinta €	kpl/ laatikko
70304100H	8338700	I-sankapari 100 mm HST	pari	13,65	
70304120H	8338624	I-sankapari 125 mm HST	pari	14,60	
70304160H	8338623	I-sankapari 160 mm HST	pari	15,33	
70304200H	8338622	I-sankapari 200 mm HST	pari	16,30	
70304250H	8338621	I-sankapari 250 mm HST	pari	19,98	
70304131H	8338620	I-sankapari 315 mm HST	pari	22,52	
70304140H	8338619	I-sankapari 400 mm HST	pari	25,40	
70304150H	8338618	I-sankapari 500 mm HST	pari	29,00	
70304163H	8338617	I-sankapari 630 mm HST	pari	37,50	
70304180H	8338616	I-sankapari 800 mm HST	pari	45,61	
70304111H	8338615	I-sankapari 1000 mm HST	pari	50,53	
ER01756	8338701	I-sankapari 1250 mm HST	pari	86,81	
111603306	8331598	Konsolikannake tuella 300 mm	kpl	11,83	
85000400	3219103	Konsolikannake tuella 400 mm	kpl	14,41	
111603308	3219104	Konsolikannake tuella 500 mm	kpl	16,86	
85000600	8331599	Konsolikannake tuella 600 mm	kpl	17,76	
111603310	3219106	Konsolikannake tuella 800 mm	kpl	25,16	
85001000	8331650	Konsolikannake tuella 1000 mm	kpl	40,09	
111603314	8331651	Konsolikannake tuella 1200 mm	kpl	70,31	
70100056	8331652	Kierretanko M8/2000mm DIN 975	m	1,24	100
70500008	8331557	Asennuskisko L-kisko 30/2mm (2m)	m	5,28	20
70500009	8331558	Asennuskisko U-kisko 30/30/2mm (2m)	m	8,16	20
701000024	8331590	C-työntölista 2 m	m	1,06	100
H70100003	8331591	C-työntölista 2 m, HST	m	5,84	
701000261	8331592	Z/IT-lista 4 m	m	3,26	100
701000411	8331593	Z/IT-lista 2 m	m	3,06	50
70100031	8331581	Z/IT-listan tiiviste L-profiili 16x16	m	0,71	100
H70100026	8331594	Z/IT-lista, HST	m	15,08	
H701000271	8331597	Z/IT-listan sisäkulma, HST	kpl	0,48	250
701000271	8331595	Z-listan sisänurkka (ETS)	kpl	0,41	500
701000361	8331596	Z-listan ulkonurkka (ETS)	kpl	0,29	100
70100037-1	8331583	E205 Eurolista DW20 tiivistysmassalla (5m/kpl / 500m/pkt)	m	2,50	500
JP10020831	8331404	E203 Eurolista DW20 tiivistysmassalla (3m/kpl / 300m/pkt)	m	2,50	300
JP10030831	8331424	E305 Eurolista DW30 tiivistysmassalla (3m/kpl / 300m/pkt)	m	2,98	300
70100039-1	8331584	E305 Eurolista DW30 tiivistysmassalla (5m/kpl / 500m/pkt)	m	2,98	500
70100005-1	8331586	H30 Eurolistan sisäkulma	kpl	0,89	250
70100004-1	8331585	H20 Eurolistan sisäkulma	kpl	0,49	500
70100014	8331589	CM 3,0 listakiinnike ruuvilla, EURO	kpl	0,61	500
111610072	1486000	Värinäkumi 100x100 mm s8	kpl	5,52	
111610073	1489028	Värinänvaimennin B40/100X100X40 mm	kpl	23,78	

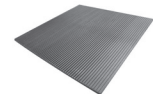
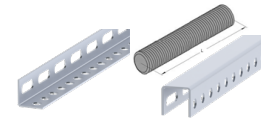

1. NORDgrille - Tulo-, poisto- ja siirtoilmasäleiköt

Tulo- ja poistoilmasäleikkö RSP	Poistoilmasäleikkö RSV	Tulo- ja poistoilmasäleikkö RPS	Tulo- ja poistoilmasäleikkö RPV	Lattiasäleikkö RPSL
				
Lattiasäleikkö RPVL	Siirtoilmasäleikkö RSO	Vaimentava siirtoilmasäleikkö RSL	Vaimentava siirtoilmasäleikkö RSM	Kiinnityskehys RSK
				

Hinnat tarjouksen mukaan.

2. NORDdiffuser - Ilmanjakolaitteet

Tuloilmahajotin DEK	Tuloilmahajotin DEN	Tuloilmahajotin DKU	Tuloilmahajotin DDR	Suutinkanava DSP
				

Hinnat tarjouksen mukaan.

Tuloilmaventtiili DSS



Koko ød	Tuotekoodi	LVI-koodi	Hinta €/kpl	kpl/laatikko
100	120223010	8740140	13,03	• 20
125	120223011	8740141	18,89	• 20
160	120223012	8740142	24,52	• 15
200				
250				

Tuloilmaventtiili DVP



Tuotekoodi	LVI-koodi	Hinta €/kpl	kpl/laatikko
52120100	8740143	9,27	• 7
52120125	8740144	12,27	• 7
52120160	8740145	17,64	• 7
52120200	8740146	22,29	• 7
52120250	8740147	41,89	• 7

Poistoilmaventtiili DSE



Koko ød	Tuotekoodi	LVI-koodi	Hinta €/kpl	kpl/laatikko
120216010	8740131	10,32	13,62	• 24
120216011	8740132	13,30	17,56	• 20
120216012	8740133	19,50	25,74	• 15
120216013	8740134	23,52	31,04	• 10

Poistoilmaventtiili DVS



Tuotekoodi	LVI-koodi	Hinta €/kpl	kpl/laatikko
52110100	8740135	9,57	7
52110125	8740136	12,66	7
52110160	8740137	18,23	7
52110200	8740138	23,01	7
52110250	8740139	43,26	7

Ilmanjakolaitteet

2. NORDdiffuser - Ilmanjakolaitteet

Tuloilmaventtiili
DSK-P (100, 125)
DSK (160, 200)

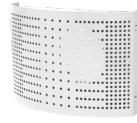

Kiinnityskehys kanavaan
RLT



Koko ød	Tuotekoodi	LVI-koodi	Hinta €/kpl	kpl/laatikko
100	EI00341	8632117	49,25	• 12
125	EI00342	8632118	49,96	• 12
160	KS01517	8632203	164,20	
200	EI01117	8632204	189,24	

Tuotekoodi	LVI-koodi	Hinta €/kpl	kpl/laatikko
120239011	8740148	3,60	• 69
120239012	8740149	4,56	• 44
120239013	8740150	5,41	• 30
120239014	8740151	6,89	• 20

Suutinhajotin
DKZ



Suutinhajotin liitäntälaatikolla
DRZ



Koko ød-A	Tuotekoodi	LVI-koodi	Hinta €/kpl
125-300/300	110041002	8632206	103,98
125-450/300	110041003	8632207	105,50
125-600/300	110041004	8632208	160,15
160-300/300	110041005	8632209	105,50
160-450/300	110041006	8632210	105,50
160-600/300	110041007	8632211	160,15
200-450/450	110041008	8632212	130,55
200-600/450	110041009	8632213	164,70
250-600/600	110041010	8632214	193,55
315-600/600	110041011	8632215	201,14
400-600/600	110041012	8632216	217,83

Koko ød	Tuotekoodi	LVI-koodi	Hinta €/kpl
400x150/100-1	110041030	8632223	210,35
400x150/100-2	110041031	8632224	210,35
400x200/125-1	110041032	8632225	213,41
400x200/125-2	110041033	8632226	213,41
500x200/160-1	110041034	8632227	229,34
500x200/160-2	110041035	8632228	229,34
600x250/200-1	110041036	8632229	261,22
600x250/200-2	110041037	8632230	261,22
750x300/250-1	110041038	8632231	297,53
750x300/250-2	110041039	8632232	297,53

Suutinhajotin liitäntälaatikolla
DEZ



Koko ød	Tuotekoodi	LVI-koodi	Hinta €/kpl
100	110041040	8632217	202,78
125	110041041	8632218	217,83
160	110041042	8632219	255,02
200	110041043	8632220	351,54
250	110041044	8632221	419,73
315	110041045	8632222	462,23

3. Liitäntälaatikot

Liitäntälaatikko kattohajottimille mittaus- ja säätöyhteillä
SKDM



Liitäntälaatikko tulo- ja poistoilmasäleiköille mittaus- ja säätöyhteillä
SKRM



Hinnat tarjouksen mukaan.

NORDcanopy - Keittiön ilmanvaihtolaitteet

NORDcanopy-tuoteryhmä käsittää suurkeittiöiden keittiölaitteiden yläpuolelle asennettavaksi tarkoitettuja ilmastointihuuvia. NORDcanopy-tuotteet on valmistettu ruostumattomasta teräksestä EVS-EN 10088-2:2005, EN 1.4301 tai AISI 304 (AISI 304) standardin mukaisesti.

Täydellinen valikoima tuotteista löytyy www.etsnord.fi/tuotteet > NORDcanopy

HZ - Otsonaattorihuuva

Integroidulla otsonaattorilla varustettu tulo- ja poistoilmahuuva, jonka tehokkaat rasvanpoisto- ja puhdistusominaisuudet takaavat puhtaan ja hygieenisen työympäristön. Huuva poistaa rasvaisen ilman ja ylimääräisen lämmön keittiöstä erottaen rasvan poistoilmasta.



HR - Tulo- ja poistoilmahuuva rasvanpoistoon

HR on keittiölaitteen yläpuolelle asennettava tulo- ja poistoilmahuuva, joka poistaa likaista ja ylikuumaa ilmaa ja erottaa siitä rasvaa. Tuloilma kulkee huoneeseen pääasiassa laitteen etupaneelin kautta sekä lisäksi työskentelyalueen säädettävien tuloilma-aukkojen kautta.



HU - Kondenssihuuva kosteudenpoistoon

HU-höyrykupu sopii kosteutta aiheuttavien keittiölaitteiden päälle – esimerkiksi astianpesukoneet. Laitte erottelee poistoilmasta vettä kondensoimalla. Lisävarusteena on saatavana pinta-asenteinen valaisin.



HT - Kohdepoistolaite

Tyhjä poistoilmahuuva. Huuvan avulla poistetaan työvyöhykkeeltä likaa ja ylimääräistä lämpöä. Sopii teollisuustuotantoon.



HFK - Rasvasuodatin

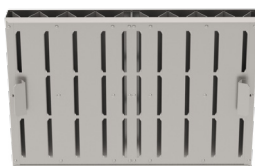

Rasvasuodatin suurkeittiöiden tai vastaavien tilojen keittiölaitteiden tuottaman rasvan ja muun lian erottamiseen poistoilmasta.

ETS NORD Apukäsi



ETS NORD Apukäden avulla ammattikeittiöt hoitavat rasvahuuvien suodattimien poistamisen puhdistusta varten helposti ja turvallisesti.

Hinnat tarjouksen mukaan.

NORDfan – puhaltimet

NORDfan -tuoteryhmämme sisältää poikkeuksellisen laajan valikoiman puhaltimia useille painetasoille ja ilmavirroille. Ilmamääräalueet voivat vaihdella 0,1–50 m³/s puhaltimen halkaisijan ollessa Ø 250–1600 mm. Puhaltimien hyötysuhde voi olla jopa yli 90%.

Meiltä saat mm:

- CE-merkityt aksiaalipuhaltimet savunpoistoon (F200, F300 ja F400)
- Katto- ja seinäasenteiset savunpoistopuhallin+luukku yhdistelmät (SPPIT ja SPPIT2)
- Suuntapainepuhaltimet autopaikoitustilojen ilmanvaihtoon ja savuhallintaan
- Sähkö- ja ohjauskeskukset erilaisiin savunhallintajärjestelmiin
- Jet-puhaltimet tunneleiden ilmanvaihtoon ja savunpoistoon
- Oviverhopuhaltimet ja kiertoilmalämmittimet erilaisiin tiloihin

Täydellinen valikoima tuotteista löytyy www.etsnord.fi/tuotteet>> NORDfan

Hinnat tarjouksen mukaan.



Recair-ilmankäsittelykoneet

Recair -tuoteryhmä koostuu pala- ja pakettikoneista. Palakoneita toimitetaan 0,3 - 10 m³/s ilmavirta-alueille ja pakettikoneita 0,3 - 4 m³/s ilmavirta-alueille.

Recair-ilmankäsittelykoneet voidaan koota erilaisista komponenteista. Näin saadaan tekniset suoritusarvot optimoitua asiakkaan tarpeisiin.

Pakettikoneen automaation taso on valittavissa juuri tarpeen mukaan: ilman automatiikkaa, riviliitinkeskuksella, sähkökeskuksella, RAU-varustetulla sähkökeskuksella tai omalla automatiikalla.

Recair-ilmankäsittelykoneita on saatavana erikoisratkaisuna myös hygieni- ja saneerauskohteisiin. Koneisiin on myös saatavilla erikoissuodattimia sekä ATEX-komponentteja.

Täydellinen valikoima tuotteista löytyy www.etsnord.fi/tuotteet > Recair

Hinnat tarjouksen mukaan.



Tilaja:		Pvm.:	
Yhteyshenkilö:		Tilausno:	
Puhelin:		Proj. nro:	
Sähköposti:		Projekti:	
Vastaanottaja:		Laskutus:	
Toimitusosoite:			
Toimitustapa:		Toimitusaika:	

EKT Kanava					EKP 90 Käyrä					EKP 45 Käyrä				
	A	B	L	Liitos		Kpl.	A	B	Liitos		Kpl.	A	B	Liitos

EKK Muunto						ESD Lähtö- kaulus								
	A	B	C	D	L		Sijainti	Liitos	Kpl.	A	B	Ød	Liitos	Kpl.

EKD Muunto						EKM T-haara								
	A	B	Ød	L	Sijainti		Liitos	Kpl.	A	B	C	D	Liitos	Kpl.

EKN S-kappale					ESS Lähtö- kaulus				EKO Pääty					
	A	B	s	L		Liitos	Kpl.	A		B	Liitos	Kpl.	A	B

Huomautukset:

ESK Lähtö- kaulus				TLT Puhdistus- luukku			TLTE Puhdistus- luukku				TL1	
A	B	Liitos	Kpl	A	B	Kpl	A	B	Eristys	Kpl	AxB	Kpl
				200	100		200	100			300x200	
				400	200		400	200			400x200	
				400	300		400	300			400x300	
				500	400		500	400			500x400	
				600	500		600	500				

Piirtämisen ohje:

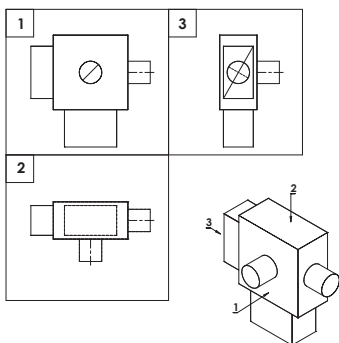

Liitoksen merkitseminen ja selitys:

Ilman merkintää on vakiona kanavan tai kanavaosan molemmissa päässä z-profiili. Eristetyn kanavan mitat ovat sisämitat ja liitoslista kiinnitetään vakiona ulkokuoreen, ellei toisin ole mainittu.

Z – Kanavan tai kanavaosan päädyssä Z-lista

Z+ – z-profiili toimitukseen mukaan irrallisena

NKV – Niittikaulus ulospäin kantattuna (mm)

NKS – Niittikaulus sisäänpäin kantattuna (mm)

E – kanavan tai kanavaosan päädyssä europrofiili (E20, E30)

E+ – Kanavan tai kanavaosan päädyssä europrofiili (E20, E30), mukaan irrallisena

LS – Eristetty kanava, jossa liitoslista kiinnitetään sisäkuoreen

Esimerkki: EKK 500x300(sk)-400x300 Muunto

Tilaja:		Pvm.:	
Yhteyshenkilö:		Tilausno:	
Puhelin:		Proj. nro:	
Sähköposti:		Projekti:	
Vastaanottaja:		Laskutus:	
Toimitusosoite:			
Toimitustapa:		Toimitusaika:	

EKT-T Kanava					EKP-T 90 Käyrä					EKP-T 45 Käyrä				
	A	B	L	Liitos		Kpl.	A	B	Liitos		Kpl.	A	B	Liitos

EKK-T Muunto						ESD-T Lähtö- kaulus							
	A	B	C	D	L		Sijainti	Liitos	Kpl.	A	B	Ød	Liitos

EKD-T Muunto						EKM-T T-haara							
	A	B	Ød	L	Sijainti		Liitos	Kpl.	A	B	C	D	Liitos

EKN-T S-kappale					ESS-T Lähtö- kaulus				EKOL-T Pääty				
	A	B	s	L		Liitos	Kpl.	A		B	Liitos	Kpl.	A

Tuotteen kuvaaminen piirustuksella

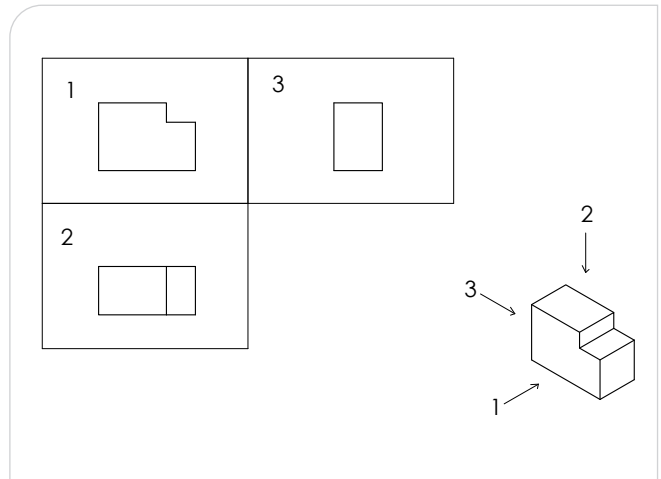
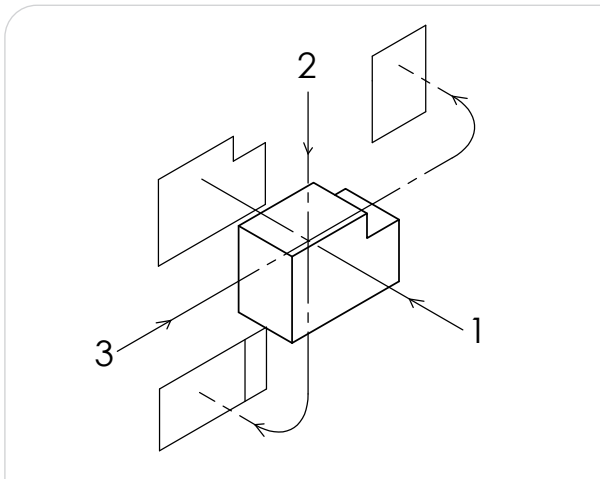

Viivat

Näkyvät muotoviivat _____

Näkymättömät muotoviivat - - - - -

Keskiviiva - - - - -

Liitoksen merkitseminen ja selitys:
Ilman merkintää on vakiona kanavan tai kanavaosan molemmissa päässä Z-profiili.
Eristetyn kanavan mitat ovat sisämitat ja liitoslista kiinnitetään vakiona ulkokuoreen, ellei toisin ole mainittu.

Z – Kanavan tai kanavaosan päädyssä Z-lista
Z+ – z-profiili toimitukseen mukaan irrallisena
NKV – Niittikaulus ulospäin kantattuna (mm)
NKS – Niittikaulus sisäänpäin kantattuna (mm)
E – kanavan tai kanavaosan päädyssä europrofiili (E20, E30)
E+ – Kanavan tai kanavaosan päädyssä europrofiili (E20, E30), mukaan irrallisena
LS – Eristetty kanava, jossa liitoslista kiinnitetään sisäkuoreen

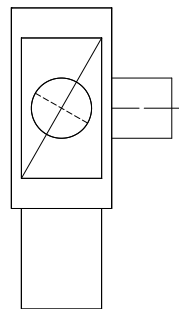
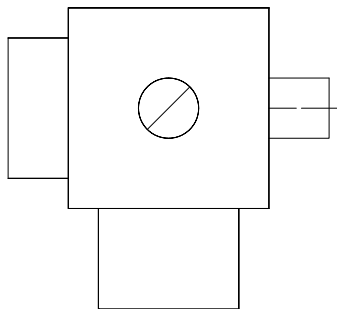

Näkyvällä puolella olevan reiän merkitseminen - **yhtenäisellä viivalla**

Näkymättömällä puolella olevan reiän merkitseminen - **katkoviivalla**

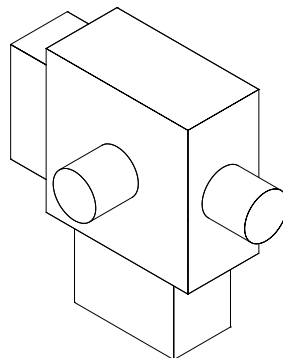
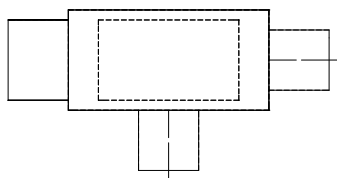

Liitostapamerkinntät

Liitoksen merkitseminen ja selitys:
Ilman merkintää on vakiona kanavan tai kanavaosan molemmissa päässä Z-profiili. Eristetyn kanavan mitat ovat sisämitat ja liitoslista kiinnitetään vakiona ulkokuoreen, ellei toisin ole mainittu.

- Z – Kanavan tai kanavaosan päädyssä Z-lista
- Z+ – z-profiili toimitukseen mukaan irrallisena
- NKV – Niittikaulus ulospäin kantattuna (mm)
- NKS – Niittikaulus sisäänpäin kantattuna (mm)
- E – kanavan tai kanavaosan päädyssä europrofiili (E20, E30)
- E+ – Kanavan tai kanavaosan päädyssä europrofiili (E20, E30), mukaan irrallisena
- LS – Eristetty kanava, jossa liitoslista kiinnitetään sisäkuoreen

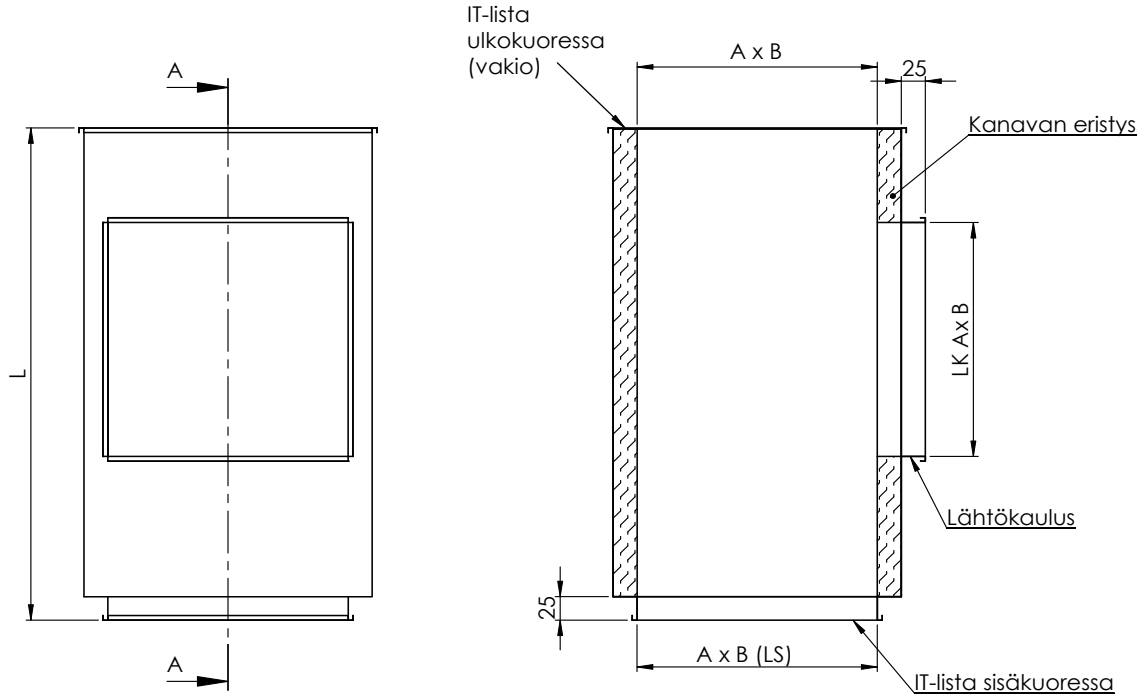

Kanavien eristys:

- S – lämpöeriste, 30, 50, 100, ... mm
- M – äänieriste, eristeen vahvuus 30, 50, 100, ... mm
- CL – Äänieristetty kanava + pestävä eriste, 30, 50, 100mm
- EI 60, 90, 120 – paloeriste (100 mm)

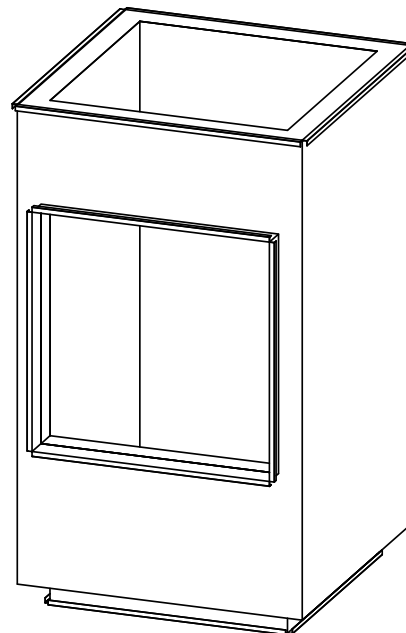

Kanavien ja kanavaosien pakkaukset

NORDduct kanavaosien pakkaukset

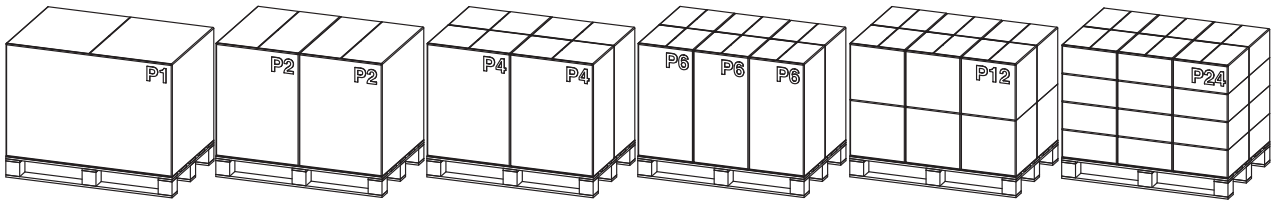

Laatikon koodi	Pituus	Leveys	Korkeus	Määrä m ³	Kpl/ alustalla
P1	1200	800	830	0,797	1
P2	600	800	930	0,446	2
P4	600	400	800	0,192	4
P6	405	405	813	0,133	6
P8	600	400	400	0,096	8
P12	400	400	400	0,064	12
P24	400	400	200	0,032	24

Kierresaumakanavien pakkauskoot

NORDduct-kierresaumakanavat toimitetaan puuhäkeissä. Kanavat Ø 100-315 mm voidaan toimittaa tilauksesta myös uudelleenkäytettävällä suojahupulla suojattuna. Suoja on avattavissa ja suljettavissa molemmista päistä.

Tuote	3m		6m	
	Kpl/ Häkki	jm	Kpl/ Häkki	jm
NTO 100	126	378	252	756
NTO 125	84	252	168	504
NTO 160	51	153	102	306
NTO 200	30	90	60	180
NTO 250	20	60	40	120
NTO 315	12	36	24	72
NTO 400	6	18	12	36
NTO 500	4	12	8	24



Tuotekoodi	Nimi	Hinta €/kpl
90790462	Kanavahäkkituoja 3 m	15,00
90790466	Kanavahäkkituoja 6 m	22,00



Yleiset toimitusehdot

1.Hinnat

Hinnaston hinnat ovat euroina arvonlisäverottomia 0% vapaasti tehtaallamme (EXW) välimyyntivarauksin.

2.Kuljetusvakuutukset ja kuljetusvahingot

Käytettäessä toimitusehtoa DAP työmaalla peritään asiakkaalta kuljetusvakuutuksen veloitus 0,65% laskun loppusummasta alv. 0%, jollei toisin ole sovittu. Kuljetusvakuutus korvaa kuljetuksen aikana sattuneen vahingon. Vahinko on todettava yhdessä vastaanottajan ja kuljettajan toimesta. Vahinko tulee merkitä rahtikirjaan.

3.Toimituskulut

Toimitettaessa tavaraa määräpaikkaan DAP, peritään asiakkaalta kuljetuksesta korvaus seuraavasti (ellei toisin ole sovittu):

Rahtiveloitus 4% laskun loppusummasta alv. 0%.

Minimirahtiveloitus 65 euroa/kuljetus.

4.Toimitusajat

Varastotuotteet 3-7 työpäivää. Muut tuotteet erillisen sopimuksen mukaan.

5.Pakkauskulut

Kierresaumakanavat Ø100-315 mm toimitetaan kertakäyttöpuuhäkissä. Puuhäkistä veloitamme 40 euroa/häkki. Pakkauksiin käytettävistä puolavoista veloitamme 8 euroa/lava.

P1- puhtausluokituksen mukaisesti toimitettavien tuotteiden pakkauslisäkustannus on 8%, jotka ei ole vakiopakattu P1-puhtausluokituksen mukaan.

6.Pientoimitukset

Käsittelykustannusten kattamiseksi perimme pientoimituslisän 20 € tavaralaskun nettoarvon jäädessä alle 200 € (alv. 0%).

7.Maksuehto

Maksuehto 14 pv netto, yliaikakorko 10%.

8.Voimassaoloaika

Tuotteiden hinnoittelussa käytetään kulloinkin viimeksi päivättyä hinnastoa. Tilaus ja tarjouspäivän hinta on voimassa enintään 3 kuukautta.

9.Omistusoikeus

Tuotteiden omistusoikeus siirtyy ostajalle, kun tavarankauppahinta on kokonaisuudessaan maksettu.

10.Välilliset vahingot

Myyjä ei vastaa välillisistä vahingoista, kuten tuotannosta johtuvasta, liikevaihdon vähentymisestä, saamatta jääneestä voitosta tai muusta vaikeasti ennakoitavasta vahingosta.

11.Palautukset

Palautettavaa tavaraa otamme vastaan ainoastaan, jos palautus johtuu omasta virheestämme.

12.Muut sopimusehdot

Kaikki oikeudet hinnaston muutoksiin pidätetään ilman ennakoilmoitusta. Muilta osin noudatamme TALTEK YT 2002-sopimusehtoja. Toimitusehtomme pätevät ainoastaan Suomessa.

Kysy lisää, me autamme!

Asiakaspalvelu:	040 184 2842
Noutopalvelu:	040 647 3997
Logistiikka:	Erki Adamson erki.adamson@etsnord.fi 050 433 8400
	Raido Akken raido.akken@etsnord.fi 040 350 3494
Tekninen laskenta:	Andres Hiiesalu 0400 354 342 andres.hiiesalu@etsnord.fi
Tekniset palvelut:	Kadi Alber kadi.alber@etsnord.fi 045 266 9999
	Oskari Mattila oskari.mattila@etsnord.fi 040 831 9120
Suunnittelijapalvelu:	Olli Suvisuo olli.suvisuo@etsnord.fi 040 1508 430
Keittiön ilmanvaihtolaitteet:	Marcus Hintze marcus.hintze@etsnord.fi 0440 304 896
Hallinto:	Jari Lehtonen jari.lehtonen@etsnord.fi 040 504 2709

Myynti

Etelä-Suomi:	Hanna Liiri hanna.liiri@etsnord.fi 045 631 9493
	Samuel Rutanen samuel.rutanen@etsnord.fi 0400 187 737
Lounais-Suomi ja Pirkanmaa:	Janne Lehtonen janne.lehtonen@etsnord.fi 050 400 3300
Itä-Suomi:	Pasi Leskinen pasi.leskinen@etsnord.fi 040 5730 657

Savo, Kaakkois- Suomi ja Päijät- Häme:	Junnu Haara junnun.haara@etsnord.fi 040 848 4847
Länsi- ja Pohjois- Suomi:	Jens Rönnqvist jens.ronnqvist@etsnord.fi 0400 562 801
NORDfan-tuotteet:	Jarkko Lahti jarkko.lahti@etsnord.fi 0500 328 3022

RECAIR-ilmankäsittelykoneet

Myynti

Etelä-Suomi:	Matti Luoma matti.luoma@recair.fi 050 430 7760
	Jyrki Niemelä jyrki.niemela@recair.fi 040 556 0951
Pirkanmaa, Keski- ja Länsi-Suomi	Ilkka Sinisalo ilkka.sinisalo@recair.fi 040 825 6628
Pohjois-, Keski- ja Itä-Suomi:	Janne Jelekäinen janne.jelekainen@recair.fi 044 528 0843
Osto ja hankinta:	Markus Onnela markus.onnela@recair.fi 044 027 7538
Tekniset palvelut:	Aleksi Kähärä aleksi.kahara@recair.fi 040 544 7687
Tuotanto:	Antti Airas antti.airas@recair.fi 040 737 5314
Tarjouslaskenta:	Heli Helimaa-Repo heli.helimaa-repo@recair.fi 050 315 6782



NORDduct



NORDrect

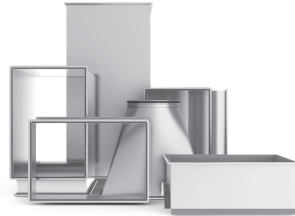

NORDsmoke



NORDsilencer



NORDdamper

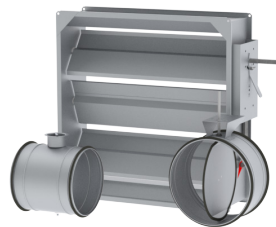

NORDfire



NORDroof

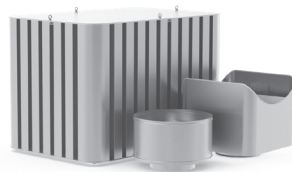

NORDExternal

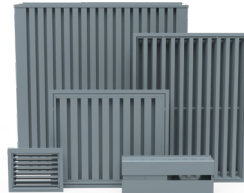

NORDdoor

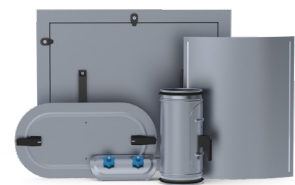

NORDdiffuser



NORDgrille



NORDcanopy



NORDaccessories

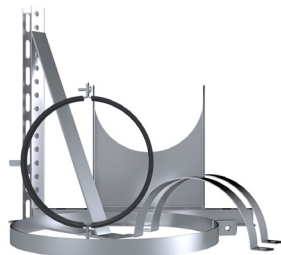

NORDfan

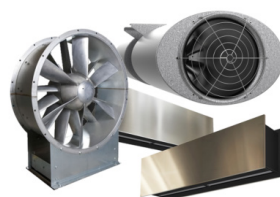

Recair



 **ETS NORD**

Pakkasraitti 4
04360 Tuusula

info@etsnord.fi
www.etsnord.fi

 **RECAIR**
ETS NORD

Pavintie 12
01260 Vantaa

info@etsnord.fi
www.etsnord.fi